

PCB 编辑器

The KiCad Team

Table of Contents

KiCad PCB 编辑器简介	2
初始配置	2
PCB 编辑器的用户界面	3
浏览编辑画布	3
快捷键	4
显示和选择控件	5
板层	5
外观面板	5
选择和选择筛选器	7
网络高亮	8
从原理图交叉探测	8
左侧工具栏显示控件	8
创建 PCB	10
PCB 的基本概念	10
性能	10
从原理图开始	10
从头开始	11
电路板设置	11
编辑电路板	24
放置和绘制操作	24
Grids and snapping	25
编辑对象属性	28
电路板边框 (Edge Cuts)	31
使用封装	31
使用焊盘	41
使用敷铜	42
布线	46
Graphics and text	67
Rule areas (keepouts)	83
锁定	84
Groups	85
Aligning objects	86
Distributing objects	88
Arrays	88
Multichannel layout	91
Importing vector drawings	97
Using reference images	97
向前和向后批注	98
检查电路板	105

设计规则检查	105
Board Statistics	121
测量工具	122
查找工具	123
搜索面板	124
3D 查看器	125
网络检查	128
生成输出	132
制造输出和绘图	132
钻孔文件	135
IPC-2581 files	137
ODB++ files	138
元件拾放文件	138
其它制造输出	140
打印	140
导出文件	141
封装和封装库	148
管理封装库	148
创建和编辑封装	150
Browsing footprint libraries	179
高级主题	182
配置和自定义	182
文本变量	187
Custom.design.rules	189
脚本	0
IDF component outlines	0
操作参考	0
PCB 编辑器	0
3D 查看器	0
通用	0

参考手册

NOTE

本手册正在修订中，以涵盖KiCad的最新稳定发布版本。它包含一些内容尚未编写完成。我们希望您能耐心等待我们的志愿技术作者完成这项工作。同时我们也欢迎新的贡献者加入我们的行列，帮助我们使 KiCad 的文档比以前更好。

Copyright

This document is Copyright © 2010-2024 by its contributors as listed below. You may distribute it and/or modify it under the terms of either the GNU General Public License (<http://www.gnu.org/licenses/gpl.html>), version 3 or later, or the Creative Commons Attribution License (<http://creativecommons.org/licenses/by/3.0/>), version 3.0 or later.

本指南中的所有商标均属于其合法所有者。

Contributors

Jean-Pierre Charras, Fabrizio Tappero, Wayne Stambaugh, Cirilo Bernardo, Jon Evans, Graham Keeth

翻译人员

Qinghan Hu <qinghan.hu@gmail.com>, 2023.

taotieren <admin@taotieren.com>, 2019-2024.

Feedback

The KiCad project welcomes feedback, bug reports, and suggestions related to the software or its documentation. For more information on how to submit feedback or report an issue, please see the instructions at <https://www.kicad.org/help/report-an-issue/>

KiCad PCB 编辑器简介

初始配置

当 PCB 编辑器第一次运行时，如果在 KiCad 配置文件夹中没有找到全局封装表文件 `fp-lib-table`，那么 KiCad 将询问如何创建这个文件：

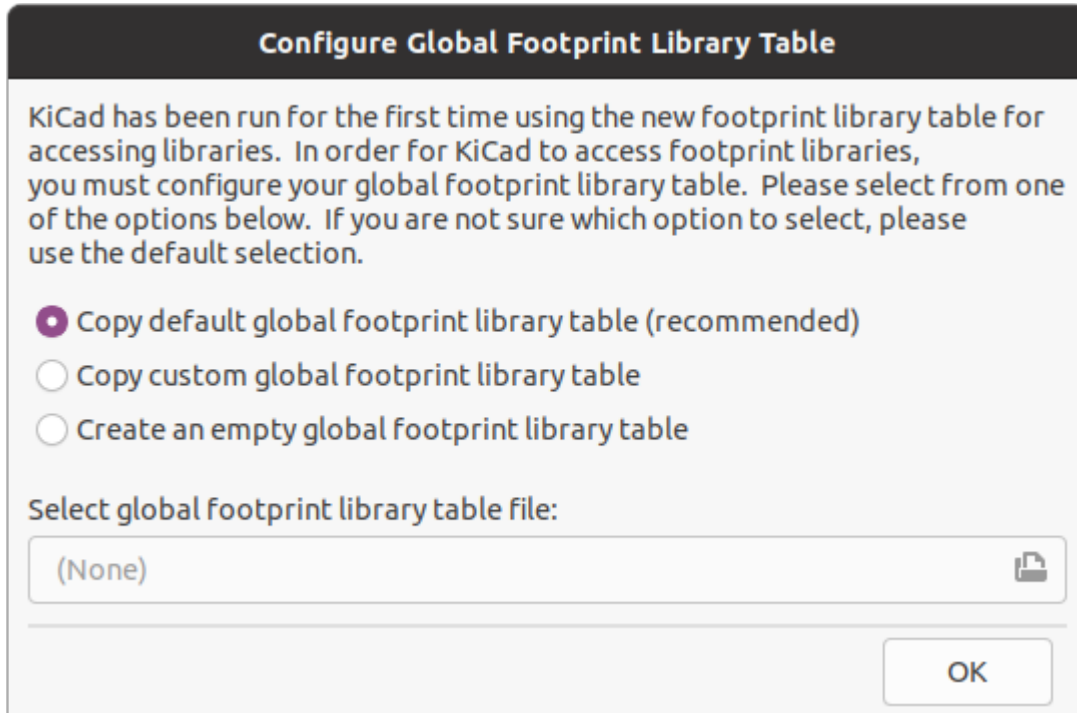

第一个选项是推荐的（**复制默认的全局封装库表**）。默认的封装库表包括所有作为 KiCad 的一部分安装的标准封装库。

如果该选项被禁用，KiCad 无法找到默认的全局封装库表。这可能意味着你没有和 KiCad 一起安装标准封装库，或者它们没有被安装在 KiCad 期望找到的地方。在某些系统中，KiCad 库是作为一个单独的软件包安装的。

- 如果你已经安装了标准的 KiCad 封装库并想使用它们，但第一个选项被禁用，选择第二个选项并浏览到安装 KiCad 库的目录中的 `fp-lib-table` 文件。
- 如果你已经有了一个你想使用的自定义封装库表，选择第二个选项并浏览到你的 `fp-lib-table` 文件。
- 如果你想从头开始构建一个新的封装库表，选择第三个选项。

Footprint library management, including how to re-run this initial configuration, is described in more detail [later](#).

PCB 编辑器的用户界面

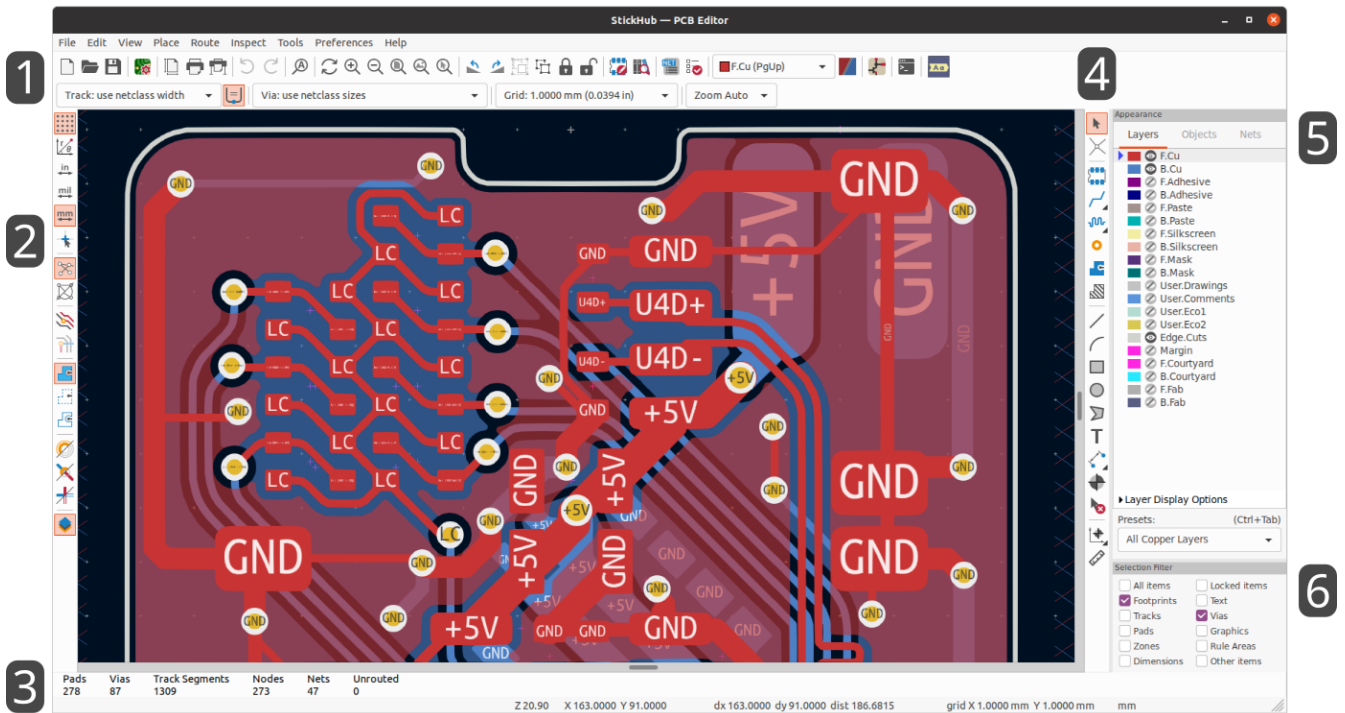

PCB 编辑器的主要用户界面如上图所示，并标明了一些关键元素：

1. 顶部工具栏（文件管理、缩放工具、编辑工具）
2. 左侧工具栏（显示选项）
3. 消息面板和状态栏
4. 右侧工具栏（绘图和设计工具）
5. 外观面板
6. 选择过滤器面板

浏览编辑画布

编辑画布是正在设计的电路板视图。您可以平移和缩放到电路板的区域，也可以翻转视图以从底部显示电路板。

默认情况下，用鼠标中键或右键拖动会平移画布视图，滚动鼠标滚轮会放大或缩小视图。你可以在偏好设置中的鼠标和触摸板部分改变这一行为（详见 [配置和定制](#)）。

在顶部的工具栏中，还有其他几个缩放工具可用：

- 放大视口的中心。
- 从视口中心缩小。
- 缩放以适应绘图页周围的框架。
- 缩放以适应绘图页内的对象。
- 允许你画一个方框来确定缩放的区域。

光标的当前位置显示在窗口的底部 (X 和 Y)，同时显示的还有当前的缩放系数 (Z)、光标的相对位置 (dx、dy 和 dist)、网格设置和显示单位。

按 `Space` 可以将相对坐标重置为零。这对于测量两点之间的距离或对齐对象很有用。

快捷键

快捷键 `Ctrl` + `F1` 显示当前快捷键列表。默认的快捷键列表包含在本手册的 [Actions Reference](#) 部分。

本手册中描述的快捷键使用了标准 PC 键盘上的按键标签。在苹果键盘布局中，使用 `Cmd` 键来代替 `Ctrl`，使用 `Option` 键来代替 `Alt`。

许多操作默认没有分配快捷键，但可以使用快捷键编辑器 ([偏好设置](#) → [偏好设置...](#) → [快捷键](#)) 分配或重新定义快捷键。

NOTE

通过快捷键可用的许多操作也可在上下文菜单中使用。要访问上下文菜单，请在编辑画布中单击鼠标右键。根据选择的内容或处于活动状态的工具，将提供不同的操作。

快捷键存储在 KiCad 的配置目录下的 `user.hotkeys` 文件中。这个位置是特定于平台的：

- Windows: `%APPDATA%\kicad\8.0\user.hotkeys`
- Linux: `~/.config/kicad/8.0/user.hotkeys`
- macOS: `~/Library/Preferences/kicad/8.0/user.hotkeys`

KiCad 可以使用快捷键编辑器中的 [导入快捷键](#) 按钮从 `user.hotkeys` 文件中导入快捷键设置。

显示和选择控件

板层

PCB 编辑器中的层代表电路板上的物理铜层，以及用于定义丝印、阻焊和电路板边框等的图形层。在编辑器中，总有一个层是活动的。活动图层绘制在其他图层之上，并将成为分配给新创建对象的图层。活动层在顶部工具栏的图层选择器下拉框中显示，在外观面板中也被突出显示。要改变活动层，你可以左键单击外观面板中的层名，使用顶部工具栏中的下拉层选择器，或使用快捷键。图层可以被隐藏以简化电路板视图。你可以隐藏一个层，即使它是活动层。

电路板层的显示顺序

The display order for board layers is dynamic and depends on which layer is selected as the active layer. The active layer is always drawn on top of other layers. In addition, layers that are related to the active layer are drawn on top of layers that are unrelated. For example, if you make B.Silkscreen the active layer, then all of the other back layers (B.Cu, B.Adhesive, B.Paste, B.Mask, B.Fab, and B.Courtyard) will be drawn on top of the front, user, and inner copper layers, with B.Silkscreen topmost. If you make Edge.Cuts active, then it will be drawn on top, and the User.* layers and Margin will also be brought to the front.

NOTE Selected objects are always drawn on top, even if they are not on the active layer.

外观面板

外观面板提供了管理 PCB 编辑器绘图画布中的对象的可见性、颜色和不透明度的控制。它有三个标签：层标签包含电路板层的控制，对象标签包含不同类型图形对象的控制，网络标签包含飞线和铜对象的外观控制。

图层控件

在外观面板的“层”选项卡中，每个电路板层都显示了其颜色和可见性状态。活动层在色块的左边有一个箭头指示器。左键单击一个图层来选择它作为活动图层。左键单击相应的可见性图标，在可见和隐藏之间切换该图层。双击或中击色块来改变该图层的颜色。

NOTE 必须先在偏好选项中创建自定义颜色主题，然后才能在“外观”面板中更改图层颜色。

在图层列表下方是一个包含图层显示选项的可展开面板。第一个设置控制非活动图层的显示方式：正常、暗显或隐藏。层显示模式可用于简化视图并聚焦于单个层。当非活动层显示模式为“暗显”或“隐藏”时，不能选择非活动层上的对象。您可以使用快捷键 **Ctrl + H** 快速切换这些显示模式。

Flip board view will show the board as if you are looking from the bottom (that is, mirrored around the Y-axis). This option is also available in the View menu.

NOTE 翻转电路板视图不会更改可视层顺序，活动层将保持在最前面，其他层按正常顺序紧随其后。

对象控件

外观面板的“对象”选项卡与“图层”选项卡类似。主要区别在于，有些对象没有颜色设置，而四种类型的对象（布线、过孔、焊盘和敷铜）有不透明度控制滑块。这里的不透明度设置将与图层颜色中设置的任何不透明度相乘。默认情况下，所有对象都是完全不透明的，除了敷铜，敷铜被设置为半透明，以便通过敷铜区域更容易看到对象。

图层预设

图层预设存储了哪些图层和对象是可见和隐藏的，以便于调用。有几个内置的图层预设，您也可以保存您自己的自定义预设。自定义预设存储在一个电路板的工程设置中，因为预设可能是特定于某个电路板的层叠。

要加载一个预设，请从外观面板底部的预设下拉菜单中选择它，或者通过按住 **Ctrl** 并按 **Tab** 来使用快速切换器。一旦快速切换器窗口出现，你可以按 **Tab** 和 **Shift + Tab** 来循环浏览可用的预设。当你放开 **Ctrl** 键时，高亮显示的预设将被加载。

To save a custom preset, first use the visibility controls to choose which layers you want visible, then choose **Save preset...** from the Presets drop-down menu. Give your preset a name and it will now be available via the drop-down menu and the quick switcher. To modify a custom preset, follow the same process and save the modified version with the same name to overwrite the existing version. To delete a custom preset, choose the **Delete preset...** option from the drop-down menu and select the preset to be deleted from the list.

Viewports

Viewports store the current view location and zoom level so you can quickly switch back to it later, or switch between several saved views.

To load a viewport, choose it from the Viewports drop-down menu at the bottom of the appearance panel or use the quick switcher by holding down **Shift** and pressing **Tab**. Once the quick switcher window appears, you can press **Tab** to cycle through the stored viewports. When you let go of the **Shift** key, the highlighted viewport will be loaded.

To save a new viewport, scroll and zoom to show the desired area of the board, then choose **Save viewport...** from the Viewports drop-down menu. Give your viewport a name and it will now be available via the drop-down menu and the quick switcher. To modify an existing viewport, save a new viewport with the same name to overwrite the existing version. To delete a viewport, choose the **Delete viewport...** option from the drop-down menu and select the preset to be deleted from the list.

网络和网络类控件

外观面板的网络选项卡显示电路板中所有网络和网络类的列表。每个网络都有一个可见性控件，用于控制该网络在飞线中的可见性。在飞线中隐藏网络不会改变电路板的连接性，也不会影响设计规则检查器；这只是为了使飞线更容易理解。

Each net and net class can also have a color assigned. By default, this color applies to the ratsnest lines for the net (or for all the nets in the net class). Nets have no color by default; this is indicated by a checkerboard pattern in the color swatch. Double-click or right-click a net or net class color swatch to set the color. To give a net class the same color it has in the schematic, right click the net class and select **Use color from schematic**.

NOTE

默认网络类不能分配颜色，因为该类中的网络将仅使用颜色主题定义的默认飞线颜色。

您还可以通过外观面板选择并高亮网络和网络类：右击网络或网络类以在菜单中显示这些选项。

网络类列表下面是一个包含网络显示选项的可扩展面板。第一个选项控制如何应用网络颜色。当选择了“所有”时，属于网络或网络类的所有铜对象（焊盘、布线、过孔和敷铜）都将呈现所选的颜色。当选中“飞线”（默认值）时，只有飞线受网络和网络类颜色的影响。当选择“无”时，网络和网络类颜色被忽略。

第二个选项控制如何绘制飞线。“所有图层”表示将在所有未连接的项目之间绘制飞线。“可见层”意味着不会向隐藏层上的项目绘制任何最新的飞线，即使这些项目是未连接的。

NOTE

You can configure the thickness of ratsnest lines in the PCB Editor Editing Options section of the Preferences dialog, to make the ratsnest more or less visible.

选择和选择筛选器

选择编辑画布中的对象是用鼠标左键完成的。单独点击一个对象将选择该对象，而拖动将执行框选。从左到右的框选将只选择完全在框内的对象。从右到左的方框选择将选择任何接触到方框的对象。从左到右的选择框是用黄色画的，光标表示排他性选择，从右到左的选择框是用蓝色画的，光标表示包容性选择。

可以通过在单击或拖动的同时按住快捷键来修改选择操作。单击以选择单个对象时，将应用以下快捷键：

修改键 (Windows)	修改键 (Linux)	修改键 (macOS)	选择效果
Ctrl	Ctrl	Cmd	切换选择。注意：Ctrl + 点击可以被重新设置为高亮网络。偏好设置 → PCB 编辑器 → 编辑选项。
Shift	Shift	Shift	将该对象添加到现有的选择中。
Ctrl + Shift	Ctrl + Shift	Cmd + Shift	从现有的选择中删除对象。
长点击	长点击或 Alt	长点击或 Option	从弹出式菜单中澄清选择。

拖动以执行选框时，将应用以下快捷键：

修改键 (Windows)	修改键 (Linux)	修改键 (macOS)	选择效果
Ctrl	Ctrl	Cmd	切换选择。
Shift	Shift	Shift - Shift	将对象添加到现有的选择中。
Ctrl + Shift	Ctrl + Shift	Cmd + Shift	从现有选择中删除对象。

PCB 编辑器窗口右下角的选择过滤器面板控制哪些类型的对象可以用鼠标选择。关闭不需要的对象类型的选择，可以使在密集的电路板上选择项目更加容易。“所有项目”复选框是打开和关闭其他项目的一个快捷方式。“锁定的项目”复选框与其他项目无关，它控制是否可以被选择被锁定的项目。你可以右键单击选择过滤器中的任何对象类型，快速改变过滤器，只允许选择该类型的对象。

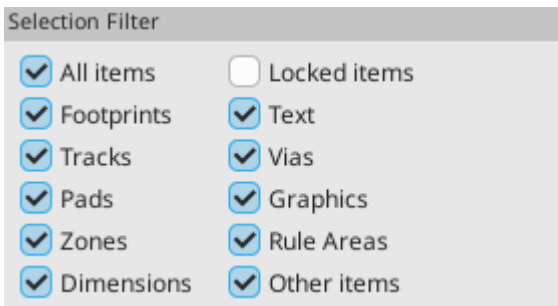

当一个连接的铜对象被选中时，你可以使用右键菜单中的“扩展选择”命令或快捷键 U 将选择扩展到同一网络的其他铜线对象。第一次运行这个命令时，选择将被扩展到最近的焊盘。第二次，选择将被扩展到所有层上的所有连接

项。

选择一个对象会在窗口底部的信息面板上显示该对象的信息。双击一个对象可以打开一个窗口来编辑该对象的属性。

按 **Esc** 将始终取消当前工具或操作，并返回到选择工具。在选择工具处于活动状态时按 **Esc** 将清除当前选择。

网络高亮

电气网络（或一组网络）可以在 PCB 编辑器中被高亮显示，以显示该网络是如何在 PCB 上布线的。通过在 PCB 编辑器中选择要高亮的网络，或者在启用交叉探测高亮时在原理图编辑器中选择相应的网络，可以激活网络的高亮（见下文）。当网络高亮激活时，高亮的网络将以较亮的颜色显示，所有其他对象将以比正常颜色更暗的颜色显示。

There are several ways to select a net or nets to highlight in the PCB editor:

- Use the hotkey **~** after selecting a copper object, or while hovering over a copper object
- Right click a copper object in the editing canvas and select **Net Inspection Tools** → **Highlight Net**
- Right click a net in the **Nets** tab of the Appearance panel and select **Highlight**
- Double click a net in the [Net Inspector](#)

When you press the Highlight Net hotkey, the nets of any selected copper items will be highlighted. If no copper items are selected, the net of the copper item under the editor cursor will be highlighted.

Net highlighting can be cleared by using the Clear Net Highlight action (hotkey **~**) or by using the Highlight net tool on an empty region in the board. By default, **Esc** also clears net highlighting, but this can be disabled if desired in **Preferences** → **PCB Editor** → **Editing Options**.

选择一个或多个网络进行高亮时，左侧工具栏上的切换网络高亮显示操作将被激活（也可通过快捷键 **Ctrl** + **~** 访问）。此操作将打开或关闭高亮，而无需选择要高亮的新网络。

从原理图交叉探测



















KiCad 允许在原理图和 PCB 之间进行双向交叉探测。有几种不同类型的交叉探测。

Selection cross-probing allows you to select a symbol or pin in the schematic to select the corresponding footprint or pad in the PCB (if one exists) and vice-versa. By default, cross-probing will result in the display centering on the cross-probed item and zooming to fit. You can disable the centering and zooming behavior, or disable selection cross-probing entirely, in the Display Options section of the Preferences dialog. Even when selection cross-probing is disabled, you can manually cross-probe from the schematic to the PCB by right-clicking an object and selecting **Select on PCB**, or from the PCB to the schematic by right-clicking an object and choosing **Select** → **Select on Schematic**.

Highlight cross-probing allows you to highlight a net in the schematic and PCB at the same time. If the option "Highlight cross-probed nets" is enabled in the Display Options section of the Preferences dialog, highlighting a net or bus in the schematic editor will cause the corresponding net or nets to be highlighted in the PCB editor.

左侧工具栏显示控件

左侧的工具栏提供了改变 PCB 编辑器中对象显示的选项。

	Turns grid display on/off. Note: by default, hiding the grid does not disable grid snapping . This behavior can be changed in the Display Options section of Preferences.
	Turns item-specific grid overrides on/off.
	Switch between polar and Cartesian coordinate display in the status bar.
  	Display/entry of coordinates and dimensions in inches, mils, or millimeters.
	Switches between full-screen and small editing cursor (crosshairs).
	Switches between free angle and 45 degree mode for placement of new tracks, zones, graphical shapes, dimensions, and other objects. You can also toggle between free angle and 45 degree mode using <code>Shift + Space</code> .
	Turns the ratsnest display on/off.
	Switches between straight and curved ratsnest lines.
	Switches the non-active layer display mode between Normal and Dim. Note: this button will be highlighted when the non-active layer display mode is either Dim or Hide. In both cases, pressing the button will change the layer display mode to Normal. The Hide mode can only be accessed via the controls in the Appearance Panel or via the hotkey <code>Ctrl + H</code> .
	When a net has been selected for highlighting , switches the highlighting on or off. Note: this button will be disabled when no net has been highlighted. To highlight a net, use the hotkey <code>Ctrl + H</code> , right-click any copper object in the net and choose Highlight Net from the Net Tools menu, or right-click the net in the list in the Nets tab of the Appearance panel.
	Show zone filled areas.
	Show zone outlines only.
	Switches display of pads between filled and outline mode.
	Switches display of vias between filled and outline mode.
	Switches display of tracks between filled and outline mode.
	Shows or hides the Appearance and Selection Filter panels on the right side of the editor.
	Shows or hides the Properties Manager panel on the left side of the editor.

创建 PCB

PCB 的基本概念

KiCad 中的印刷电路板通常由代表电子元件及其焊盘的 **封装**、定义这些焊盘如何彼此连接的 **网络**、形成每个网络中焊盘之间的铜连接的 **布线**、**过孔** 和 **敷铜** 以及定义电路板边缘、丝印标记和任何其他所需信息各种图形形状组成。

KiCad 通常会将 PCB 上的网络信息与相关的原理图保持同步，但也可以直接在 PCB 编辑器中创建和编辑网络。



性能

KiCad 能够创建多达 32 个铜层、14 个技术层 (丝印、阻焊、元件粘合剂、锡膏等) 和 13 个通用绘图层的印刷电路板。

KiCad 中所有对象的内部测量分辨率为 1 纳米，测量值以 32 位整数存储。这意味着可以创建最大约 4 米乘 4 米的电路板。

KiCad 目前支持每个工程/原理图一个电路板文件。

从原理图开始

Creating a board from a schematic is the recommended workflow for KiCad. When you create a new project, KiCad will generate an empty board file with the same name as the project. To start designing the board after you have created a schematic, simply open the board file. You can do this either from the KiCad project manager, or by clicking the "Open PCB in board editor" button in the schematic editor. To import the schematic design information into the board editor, including footprints and net connections, use the **Tools** → **Update PCB from Schematic...** action (). You can also use the  icon in the top toolbar.

NOTE

从原理图更新 PCB 是将设计信息从原理图转移到 PCB 的首选方法。在旧版本的 KiCad 中，相应的过程是将网表从原理图编辑器中导出并导入到电路板编辑器中。现在已经没有必要使用网表文件了。

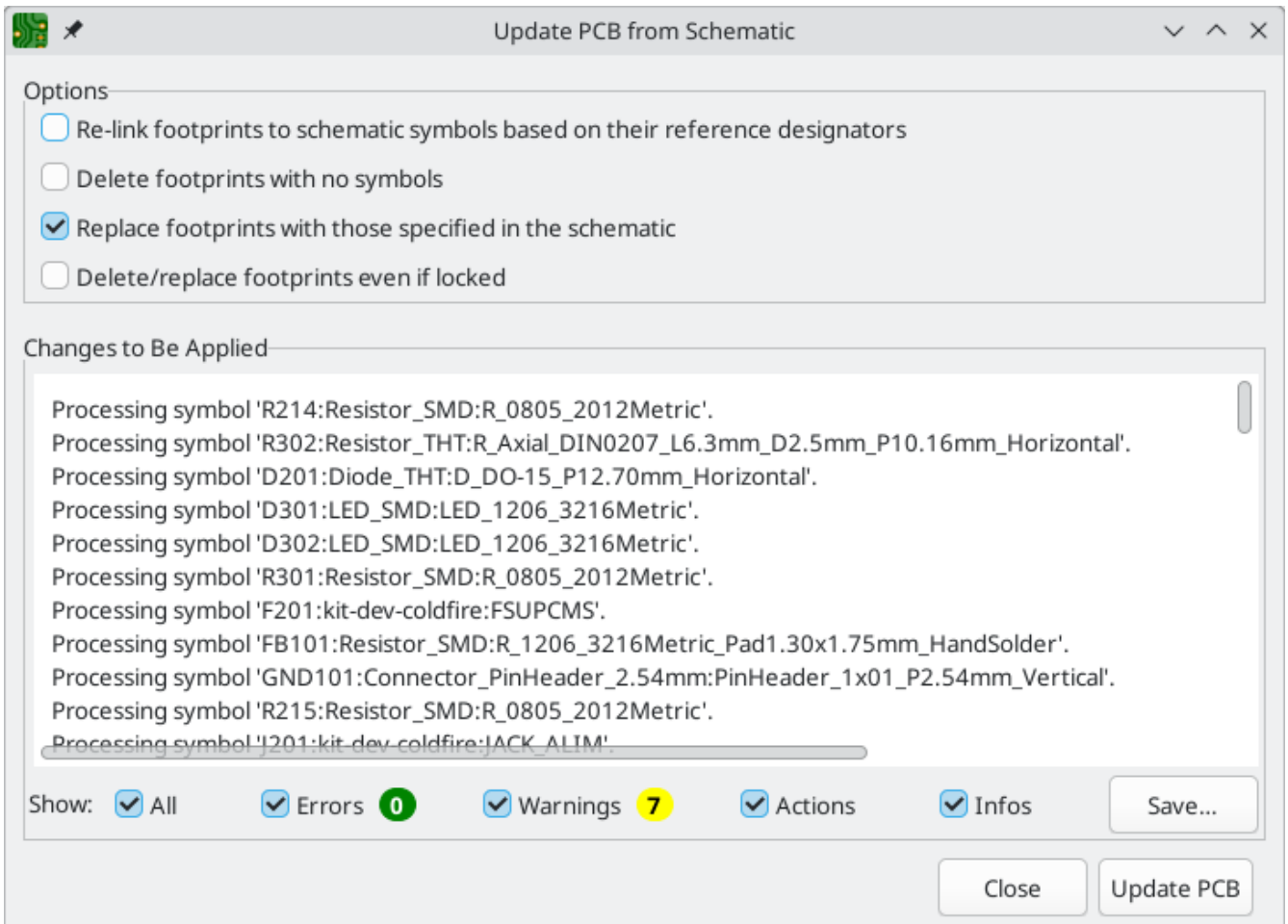

关于从原理图更新PCB工具的更多信息，请参见手册的 [\[正向批注, 正向批注\]](#) 部分。

从头开始

也可以创建一个没有匹配原理图的电路板，不过这种工作流程有一些限制，不建议大多数用户使用。为此，您必须独立启动 PCB 编辑器(而不是从 KiCad 工程管理器启动)。在开始设计之前，最好先保存电路板文件，这也将创建一个项目文件来存储电路板设置。使用文件菜单中的 "另存为..." 来选择保存电路板文件的位置。一个具有相同名称的项目文件将被创建在你选择保存电路板文件的相同位置。

电路板设置

在开始设计电路板之前，使用电路板设置对话框来配置电路板的基本参数。要打开电路板设置，请单击顶部工具栏中的  图标或从文件菜单中选择 "电路板设置..."。

配置电路板层叠和物理参数

在 "电路板设置" 中，有两个部分用于配置电路板的层叠和层。"电路板编辑器层" 部分用于启用或禁用技术层（非铜层），如果需要的话，还可以给各层自定义名称。物理层叠部分用于配置铜层的数量，以及铜层和电介质层的物理参数，如厚度和材料类型。介电层、阻焊层和丝印层可以被分配颜色，这将影响电路板在 3D 查看器中的外观。

要配置电路板的层叠，从物理层叠部分开始：



Set the number of copper layers in the upper left corner and then enter the physical parameters of the stackup if desired. These parameters may be left at their default values, but note that the board thickness value will be used when exporting a 3D model of the board, and layer thicknesses will be included in net length calculations for any nets that include vias. If you plan to use these features, it is a good idea to ensure that the stackup thickness is correct.

NOTE

KiCad 目前仅支持铜层数为偶数的层叠。要创建具有奇数层的设计 (例如, 柔性印刷电路板或金属芯印刷电路板), 只需选择下一个最高的偶数, 而忽略多余的层。

Next, if desired, use the Board Editor Layers section to rename layers or hide non-copper layers that you will not be using in the design. For example, if you will not use a back silkscreen on the design, uncheck the box next to the B.Silkscreen layer. Some layers, like F.Cu / B.Cu or Edge.Cuts, are required layers and therefore cannot be disabled.



NOTE

在电路板编辑器层部分，可以将铜层指定为信号层、电源层、混合层或跳线层。本指南仅供用户参考。无论在此对话框中将类型配置为什么，都可以在任何铜层上布线和敷铜。

You can add additional user-defined layers (User .1 , User .2 , etc.) by clicking the **Add User Defined Layer...** button in the top right. User-defined layers can't be used for routing, but they can contain arbitrary graphics or other information. By default, user layers are **auxiliary** layers, meaning that whatever information they contain does not correspond to either the front or back of the board. User layers can instead be set to **Off-board, front** or **Off-board, back**, in which case they correspond to the selected side of the board. Items on such layers can be flipped from front to back in the same way as objects on physical front/back layers. Adjacent front/back layers are treated as paired: if User .2 is defined as a front layer and User .3 is defined as a back layer, flipping an object on User .2 will move it to User .3 , and vice versa.

在电路板编辑器对话框的电路板表面处理(Board Finish)和阻焊/锡膏部分可以找到一些其他的电路板层叠设置。电路板表面处理部分包含用于定义铜的表面处理和特殊功能(如刻痕或边缘电镀)的设置。请注意，这些设置目前只影响作为 Gerber 文件一部分的电路板属性输出。

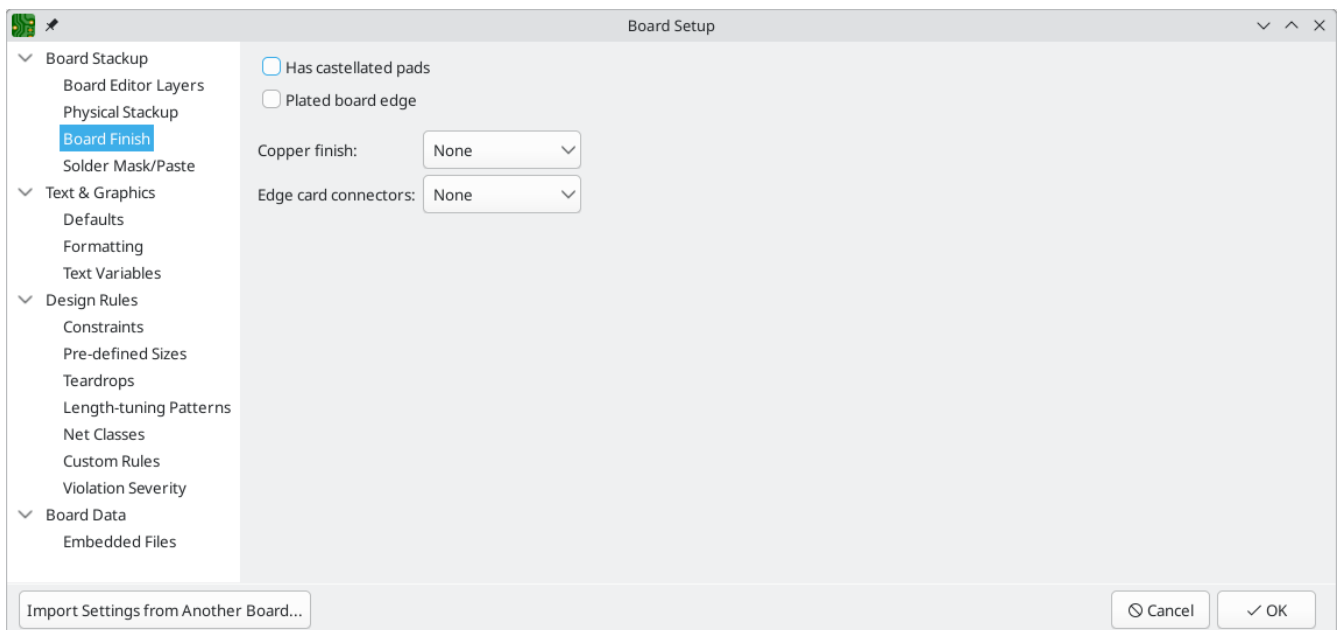

阻焊/锡膏部分允许全局调整电路板上焊盘的铜形和阻焊/锡膏形之间的间隙(正或负)。这些值将被添加到在个别封装或焊盘上设置的任何间隙覆盖。正的间隙值将导致阻焊层或锡膏开口的形状比铜的形状更大。负的间隙值将导致开口比铜的形状更小。

WARNING

大多数商业 PCB 制造商希望这些值为零，并在 CAM 过程中自行调整阻焊和锡膏开口。通常最好将这些值保留为默认值零，除非您自己制作 PCB，或者您的制造商有具体建议使用不同的值。

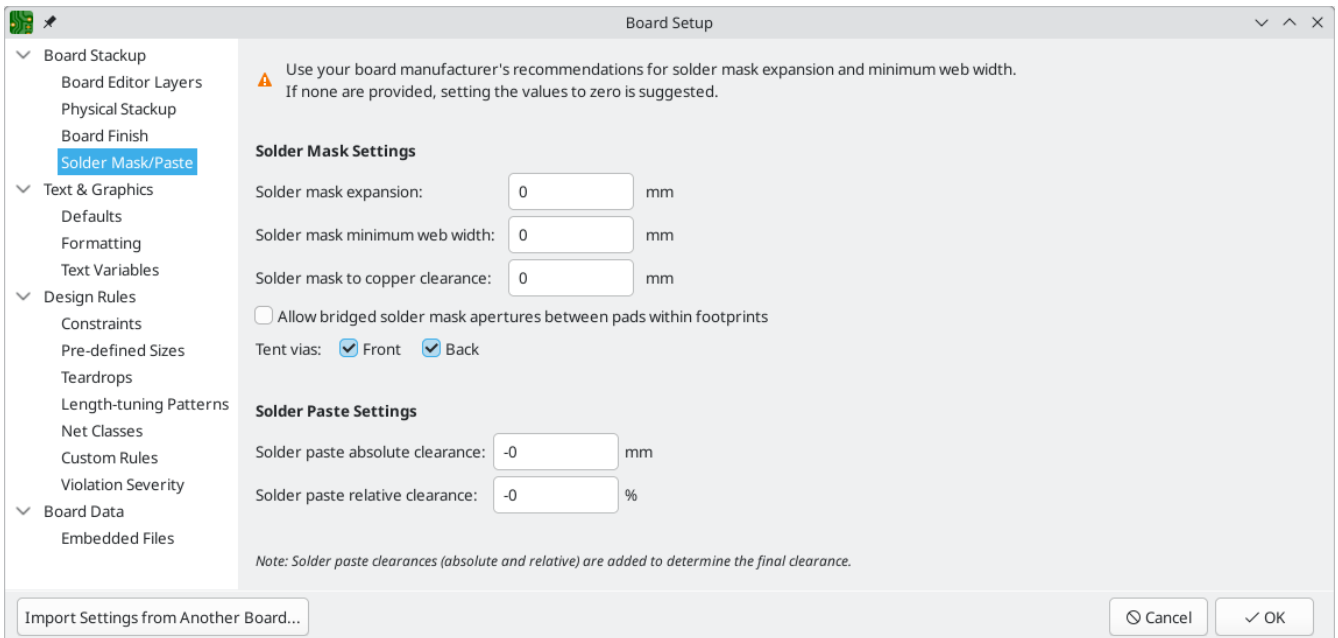

配置默认文本和图形设置

电路板设置对话框的文本和图形默认值部分可用于配置将用于放置在新文本和图形形状的属性。

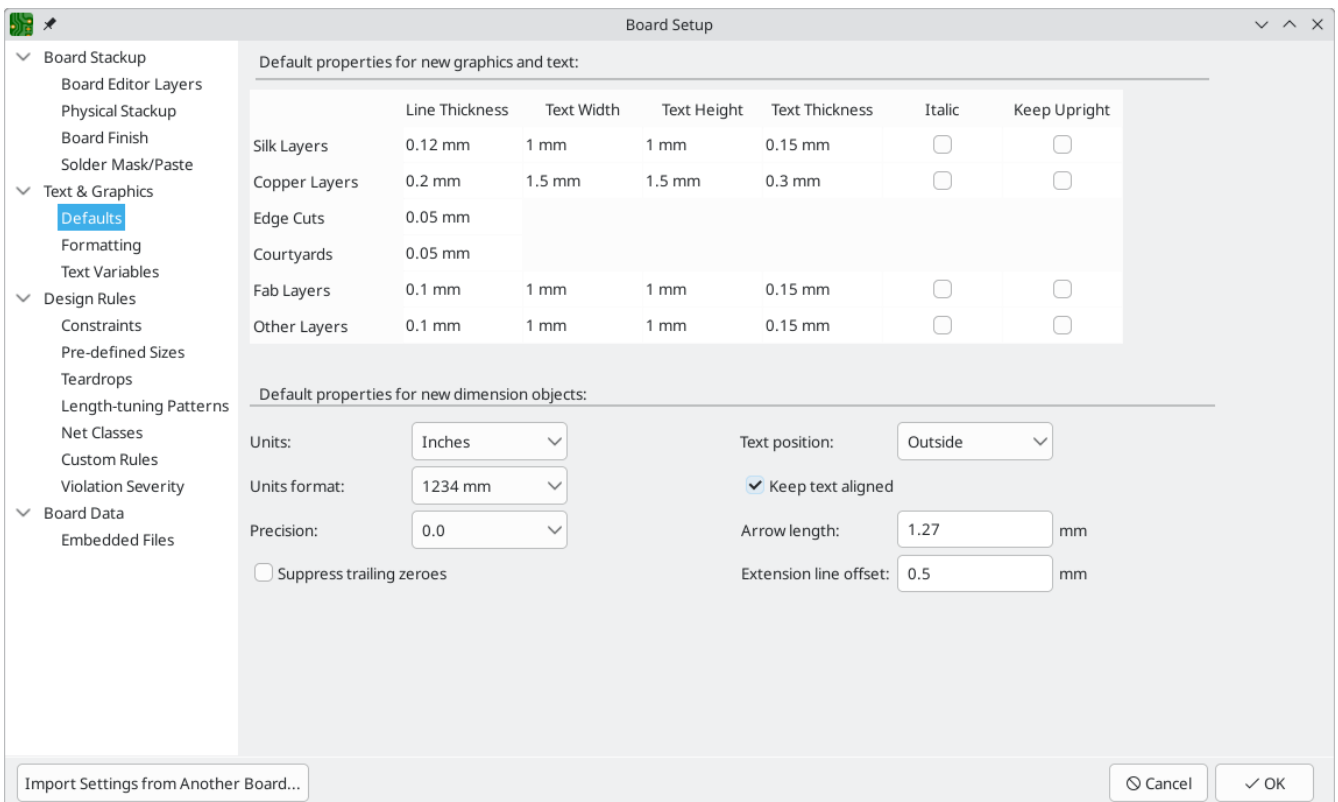

可以为对话框中显示的六种不同类别的图层配置线粗细、文本大小和文本外观。此外，可以为所有图层配置标注对象的特性。有关标注属性的更多详细信息，请参阅下面的标注部分。

虚线的外观是在“格式化”部分控制的。**虚线长度**控制虚线的长度，而**间隔长度**控制虚线和圆点之间的间距。虚线和间隔的长度是相对于行宽而言的：间隔长度为 2 意味着是行宽的两倍。

文本替换变量可以在文本变量部分创建。这些变量允许你将变量名称替换为任何文本字符串。这种替换发生在变量名称在 `{VARIABLENAME}` 的变量替换语法内的任何地方。

例如，您可以创建一个名为 VERSION 的变量，并将文本替换设置为 1.0。现在，在 PCB 上的任何文本对象中，您可以输入 `${VERSION}`，KiCad 将替代 1.0。如果你把变量改为 2.0，每个包括 `${VERSION}` 的文本对象都会自动更新。你也可以混合使用普通文本和变量。例如，你可以创建一个文本对象，内容为 版本：`${VERSION}`，它将被替换为 版本：1.0。

文本变量也可以在 [原理图设置](#) 中创建。文本变量是项目范围内的；在原理图编辑器中创建的变量在电路板编辑器中也可用，反之亦然。

还有一些 [内置系统文本变量](#)。

配置设计规则

Design rules control the behavior of the interactive router, the filling of copper zones, and the [design rule checker](#). Design rules can be modified at any time, but we recommend that you establish all known design rules at the beginning of the board design process.

约束

Basic design rules are configured in the Constraints section of the Board Setup dialog. Constraints in this section apply to the entire board and should be set to the values recommended by your board manufacturer. Any minimum value set here is an *absolute* minimum and cannot be overridden with a more specific design rule. For example, if you need the copper clearance on part of a board to be 0.2mm and in the rest 0.3mm, you must enter 0.2mm for the minimum copper clearance in the Constraints section and use a net class or custom rule to set the larger 0.3mm clearance.



除了设置最小间隙外，还可以在此处配置许多功能：

Setting	Description
Arc/circle approximated by segments	In some situations, KiCad must use a series of straight line segments to approximate round shapes such as those of arcs and circles. This setting controls the maximum error allowed by this approximation: in other words, the maximum distance between a point on one of these line segments and the true shape of the arc or circle. Setting this to a lower number than the default value of 0.005mm will result in smoother shapes, but can be very slow on larger boards. The default value typically results in arc approximation error that is not detectable in the manufactured board due to manufacturing tolerances.
Allow fillets outside zone outline	Zones can have fillets (rounded corners) added in the Zone Properties dialog. By default, no zone copper, including fillets, is allowed outside the zone outline. This effectively means that inside corners of the zone outline will not be filleted even when a fillet is configured. By enabling this setting, inside corners of the zone outline will be filleted even though this results in copper from the zone extending outside the zone outline.
Minimum thermal relief spoke count	This sets the minimum acceptable number of thermal relief spokes connecting a pad to a zone. A DRC violation will be generated if this constraint is violated.
Include stackup height in track length calculations	By default, the length tuner uses the height of the stackup to calculate the additional length of a track that travels through vias from one layer to another. This calculation relies on the board stackup height being correctly configured. In some situations, it is preferable to ignore the height of vias and just calculate the track length assuming that vias add no length. Disabling this setting will exclude via length from length tuner track length calculations.

预定义大小

The pre-defined sizes section allows you to define the track and via dimensions you want to have available while routing tracks. Net classes can be used to define the default dimensions for tracks and vias in different nets (see below) but defining a list of sizes in this section will allow you to step through these sizes while routing. For example, you may want the default track width on a board to be 0.2 mm, but use 0.3 mm for some sections that carry more current, and 0.15 mm for some sections where space is limited. You can define each of these track widths in the Board Setup dialog and then switch between them when routing tracks.



Teardrops

The teardrops section lets you set default parameters for various types of teardrops. There are different settings for teardrop connections to round objects, rectangular objects, and teardrop connections between tracks. The default teardrop parameters can be overridden when teardrops are added, and also changed in the properties for individual connected items. See the [teardrops documentation](#) for more information about each setting.

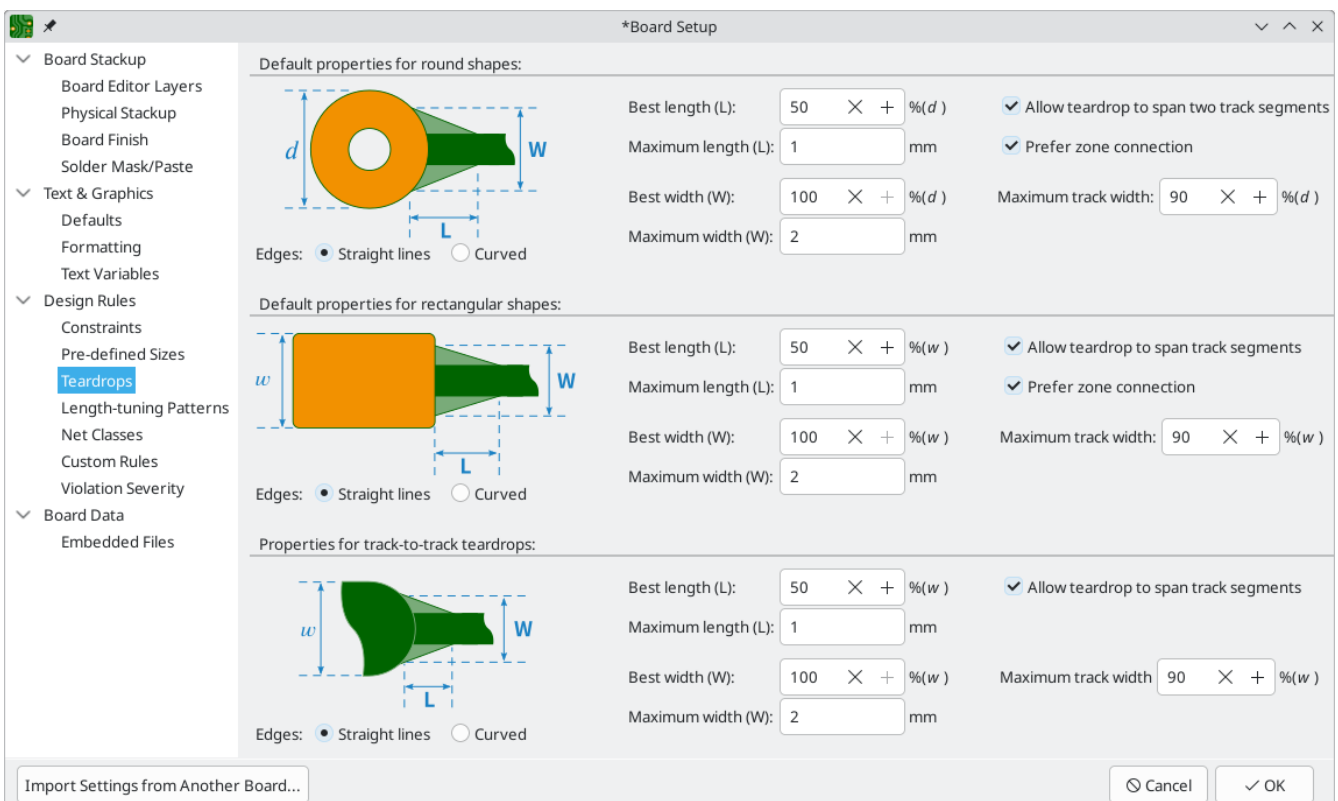

Length-tuning patterns

The length-tuning patterns section lets you set default parameters for each type of length-tuning pattern (single-track length, differential-pair length, and differential-pair skew). These defaults can be overridden in

the properties of each tuning pattern added to the board. See the [length tuning documentation](#) for more information.

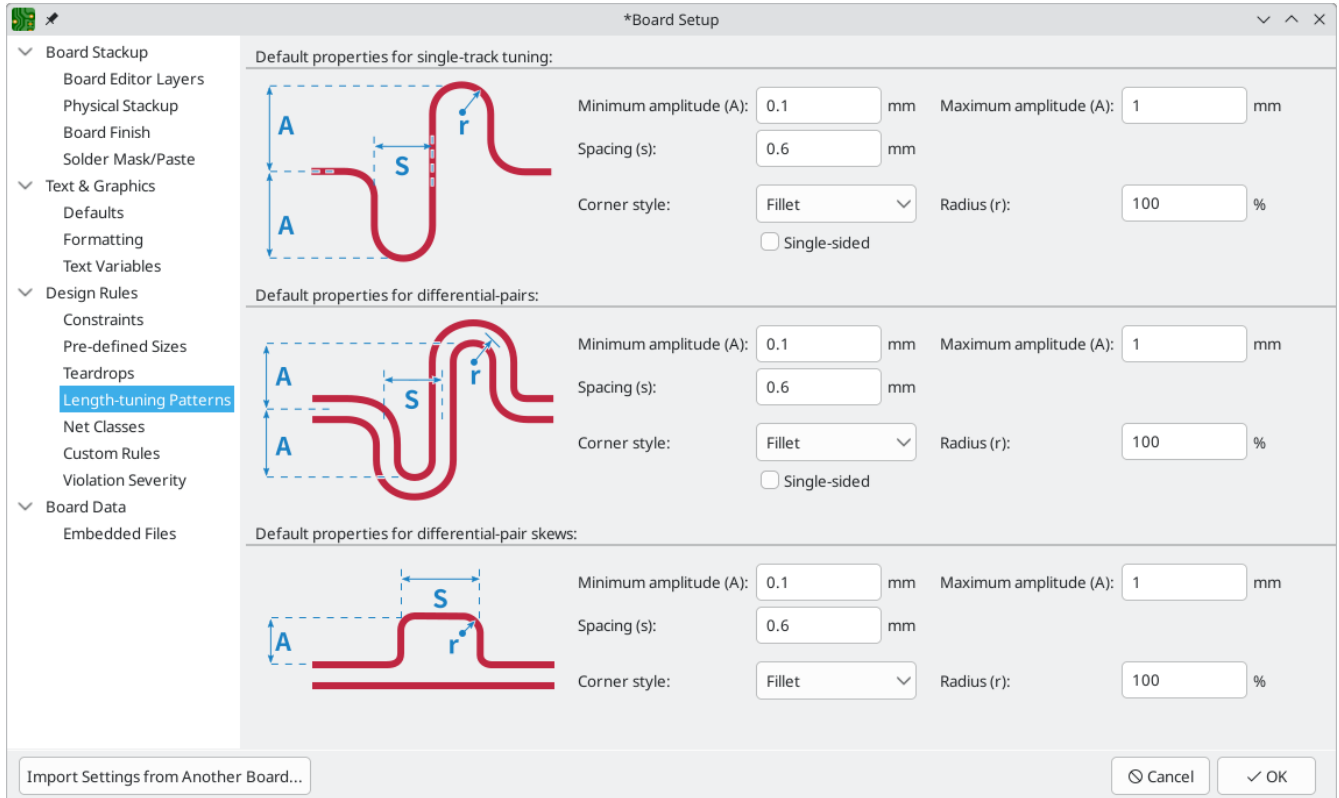

网络类

The Net Classes section allows you to configure routing and clearance rules for different classes of nets.

More than one net class can be assigned to a net. For nets with multiple net classes assigned, an effective aggregate net class is formed, taking any net class properties from the highest priority net class which has that property set. Net class priority is determined by the ordering in the Schematic or Board Setup dialogs. The **Default** net class is used as a fallback for any missing properties after all explicit net classes have been considered; this means that nets may be part of the **Default** net class even if they have other net classes explicitly assigned.

[Net classes may be created and edited](#) in either the Schematic or Board Setup dialogs.



网络类部分的上部有一个表格，显示了设计中的网络类和适用于每个网络类的设计规则。每个类别都有铜的间隙、布线宽度、过孔尺寸和差分对尺寸的值。这些值将在创建布线和过孔时使用，除非有更具体的规则覆盖它们（见下面的自定义规则）。

NOTE

任何规则都不能覆盖电路板设置的约束条件部分中设置的最小值。例如，如果您将网络类间距设置为 0.1 mm，但约束条件部分中的最小间距设置为 0.2 mm，则该类网络的间距将为 0.2 mm。

The track widths and via sizes defined for each net class are used when the track width and via size controls are set to "use netclass values" in the PCB editor. These widths and sizes are considered the default, or optimal, sizes for that net class. They are not minimum or maximum values. Manually changing the track width or via size to a different value from that defined in the Net Classes section will not result in a DRC violation. To restrict track width or via size to specific values, use [Custom Rules](#).

Each net class can also have a color assigned to it. Depending on how net colors are configured in the [appearance panel](#), net class colors can override the default color for ratsnest lines or copper objects. In addition to arbitrary colors for each net class, you can set all net classes to use the same color as configured for them in the schematic editor by clicking the **Import colors from schematic** button. To use a layer's default color instead of overriding it with a custom net class color, set the net class color to transparent.

The lower portion of the Net Classes section lists pattern-based net class assignments. Working with pattern-based net class assignments is explained in the [Schematic Editor documentation](#); pattern-based assignments can be edited in either the Board or Schematic Setup windows.

Note that pattern-based assignments can be created directly from the PCB editing canvas by right clicking a copper track or zone and clicking **Assign netclass....** Net classes can also be assigned in the schematic using [net class directives or labels](#) instead of pattern-based assignments.

自定义规则

自定义规则部分包含一个文本编辑器，用于使用自定义规则语言创建设计规则。自定义规则用于创建基本约束或网络类设置没有涵盖的特定设计规则检查。

只有在自定义规则定义中没有错误时，才会应用自定义规则。在关闭电路板设置之前，使用检查规则语法器按钮来测试定义并修复任何问题。

See [Custom Design Rules](#) in the Advanced Topics chapter for more information on the custom rules language as well as example rules.



违规严重程度

违规严重性部分允许你配置每种设计规则检查的严重性。每条规则可以被设置为创建一个错误标记、一个警告标记或没有标记（忽略）。

NOTE

在设计规则检查器中可能会忽略个别规则违规。在违规程度部分中将规则设置为忽略将完全禁用相应的设计规则检查。请谨慎使用此设置。





For descriptions of each violation type, and how to ignore individual violations without disabling all violations of that type, see the [DRC documentation](#).

Embedding files

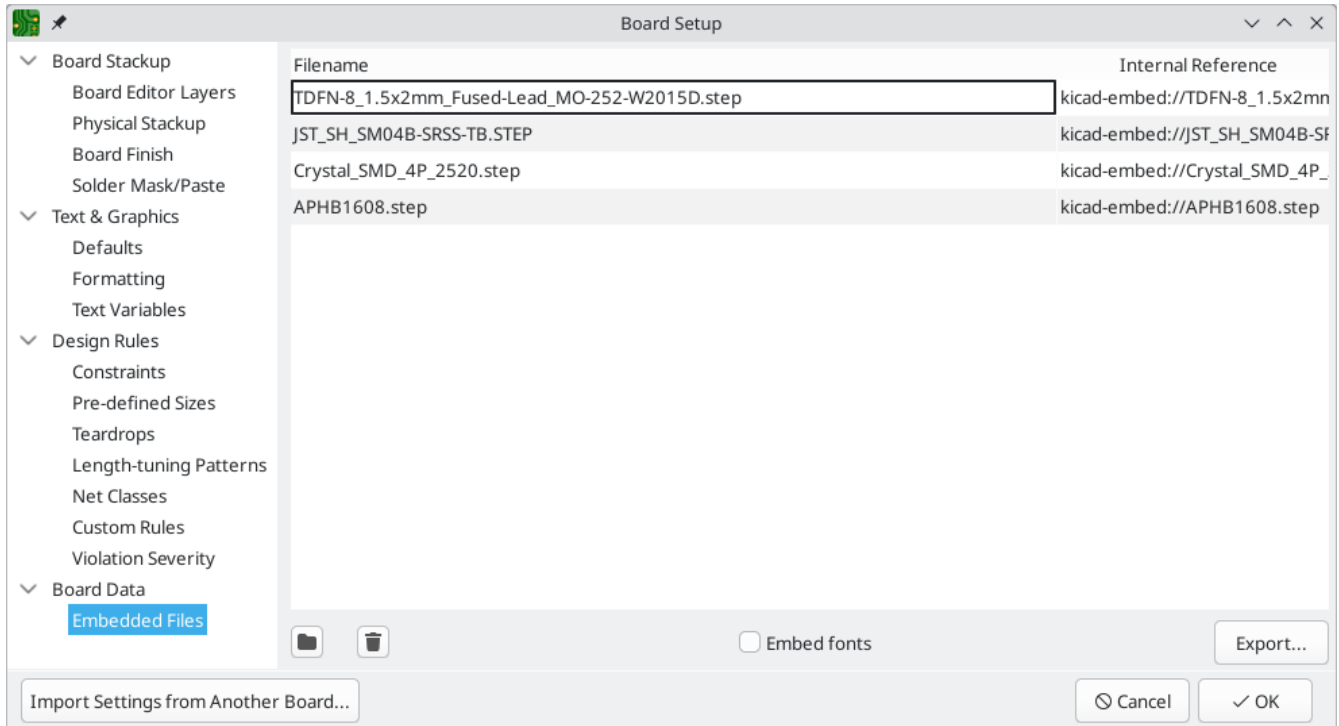
External files can be embedded within a board file. Embedding a file stores a copy of the file inside the board file. The design can then refer to the embedded copy of the file instead of the external file, which makes the project more portable as it doesn't rely on an external file. Fonts, datasheets, drawing sheets, and 3D models can be embedded and used within KiCad. Other arbitrary files can also be embedded to store them in the project for later export, but they are not used by any KiCad functionality.



Embedded files are managed in the Embedded Files section of Board Setup. To embed a file inside a board, click the  button and select the file. The file is then embedded inside the PCB and is listed in the embedded files list along with its internal reference. The internal reference is a unique identifier for the embedded file that begins with `kicad-embed://`. You can use the internal reference elsewhere in the Board Editor to refer to the embedded file as if it were an external file path. You can copy the internal reference by right clicking and selecting **Copy Embedded Reference**. To remove an embedded file, click the  button. Any remaining links to the removed file will become invalid.

To embed any fonts used in a board, check the **Embed fonts** checkbox. All fonts used in the board design will be embedded, so text using that font can be edited on any computer regardless of whether the font file is installed.

You can also [embed files in a footprint](#), either in the board copy of a footprint or in a library. Such files will be available within the footprint instance but not within the larger board design or within other footprints. Files embedded in a footprint are deduplicated when the footprint is added to a board: if a file is embedded in a footprint, and multiple instances of that footprint are added to the board, only one copy of the file will be embedded, and all of the footprint instances will refer to the same embedded file.

As an example, to embed a 3D model in a project and use it within several footprints, you could embed the model using the Board Setup dialog, copy the internal reference, and paste the internal reference as a 3D

model path in each footprint that uses that model. Alternatively, you could embed the model within a single footprint, either in the board or in the source footprint library. In this case, the footprint itself is portable if you export the footprints from the board, and the model embedding is managed in the footprint's properties rather than Board Setup.

Files can also be embedded in [schematics](#).

导入设置

您可以从现有电路板导入部分或全部电路板设置。这种技术可以用来创建一个"模板"电路板板，其中有你想在多个设计中使用的设置，然后将这些设置从模板板中导入到每个新板中，而不是手动输入。

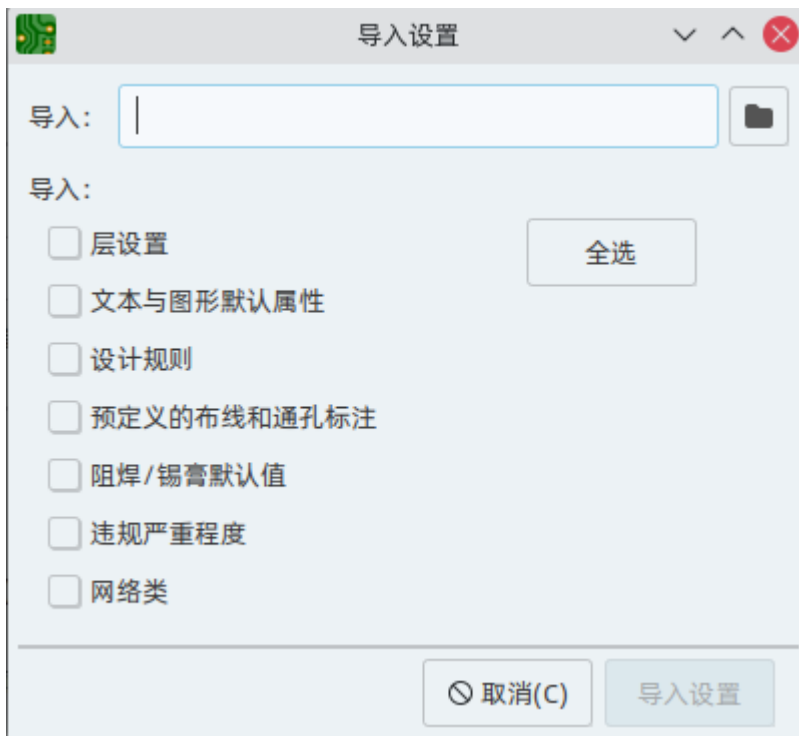

To import settings, click the **Import Settings from Another Board...** button at the bottom of the Board Setup dialog and then choose the `kicad_pcb` file you want to import from. Select which settings you want to import and the current settings will be overwritten with the values from the chosen board.

The settings that are available to import are:

- Board layers and physical stackup
- Solder mask/paste defaults
- Text and graphics default properties
- Text & graphics formatting
- Design rule constraints
- Predefined track & via dimensions
- Teardrop defaults
- Length-tuning pattern defaults
- Net classes

Custom rules

- Violation severities













编辑电路板















放置和绘制操作

放置和绘图工具位于右侧工具栏中。当一个工具被激活时，它将一直处于激活状态，直到选择了一个不同的工具或使用 **Esc** 键取消该工具。当任何其他工具被取消时，选择工具总是被激活。

某些工具栏按钮在调色板中有多个可用工具。这些工具由按钮右下角的小箭头表示：

要显示调色板，你可以在工具上点击并按住鼠标按钮，或者点击并拖动鼠标。调色板关闭时将显示最近使用的工具。

	Selection tool (the default tool).
	Local ratsnest tool : when the board ratsnest is hidden, selecting footprints with this tool will show the ratsnest for the selected footprint only. Selecting the same footprint again will hide its ratsnest. The local ratsnest setting for each footprint will remain in effect even after the local ratsnest tool is no longer active.
	Footprint placement tool : click on the board to open the footprint chooser, then click again after choosing a footprint to confirm its location.
	Route tracks / route differential pairs : These tools activate the interactive router and allow placing tracks and vias. The interactive router is described in more detail in the Routing Tracks section.
	Tune length : These tools allow you to tune the length of single tracks or the length or skew of differential pairs, after they have been routed.
	Add vias : place a standalone ("free") via without routing tracks.
	Add filled zone : Click to set the start point of a zone, then configure its properties before drawing the rest of the zone outline. Zone properties are described in more detail below.
	Add rule area : Rule areas, formerly known as keepouts, can restrict item placement and zone fills. You can also define named areas and apply specific custom DRC rules to them.
	Draw lines . Note : Lines are graphical objects and are not the same as tracks placed with the Route Tracks tool.
	Draw arcs : pick the center point of the arc, then the start and end points. By right clicking this button, you can change the arc editing mode between a mode that maintains the existing arc center and a mode that maintains the arc radius.
	Draw rectangles . Rectangles can be filled or outlines.
	Draw circles . Circles can be filled or outlines.

	Draw graphical polygons. Polygons can be filled or outlined. Note: Filled graphical polygons are not the same as filled zones: graphical polygons cannot be assigned to a net and will not keep clearance from other items.
	Draw bezier curves. Each click alternates between fixing a curve node and fixing the control handle for the node that was just placed.
	Add bitmap image for reference. Reference images are not included in fabrication outputs.
T	Add text.
	Add a textbox.
	Add a table.
    	Add dimensions.
	Deletion tool: click objects to delete them.
 	Set grid origin or drill/place origin (used for fabrication outputs).
	Interactively measure the distance between two points.

Grids and snapping

When moving, dragging, and drawing board elements, you can make these operations snap to a grid or to snapping points on pads and other items. In complex designs, snap points can be so close together that it makes the current tool action difficult. Both grid and object snapping can be disabled while moving the mouse by using the modifier keys in the table below.

NOTE

On Apple keyboards, use the **Cmd** key instead of **Ctrl**.

快捷键	效果
Ctrl	关闭网格捕捉。
Shift	关闭对象捕捉。

Tools only snap to objects on visible layers. You can reduce unwanted snapping points by hiding unneeded layers or using the single-layer view mode. Additionally, you can toggle between snapping to objects on all layers or only snapping to objects on the current layer by pressing **Shift + S**.

Snapping to different types of objects (pads, tracks, and graphics) can be configured in the Editing Options section of the PCB Editor preferences.

Snapping to graphical shapes

When working with [graphic shapes](#) like rectangles or arcs, such as when drawing shapes or when selecting a reference point for a move operation, many additional snapping points are available that let you snap to features of existing graphic shapes.

Available snapping points for graphic shapes include:

- Endpoints and corners
- Midpoints
- Centers
- Intersection points

When you hover over a snap point with a shape tool active, a graphical icon will be shown that indicates a snapping point is active and explains the type of snapping point. Clicking will use that snapping point. Some shapes display auxiliary snapping lines that appear when you snap to part of that object. For example, line segments display an auxiliary line that continues the segment beyond its endpoint, and arcs display an auxiliary circle that completes the arc's circumference. Auxiliary shapes can be used for snapping just like the original shape. An auxiliary line and circle are shown as a solid purple line in the screenshot below. The cursor indicates that the active snapping point is the endpoint of a line.

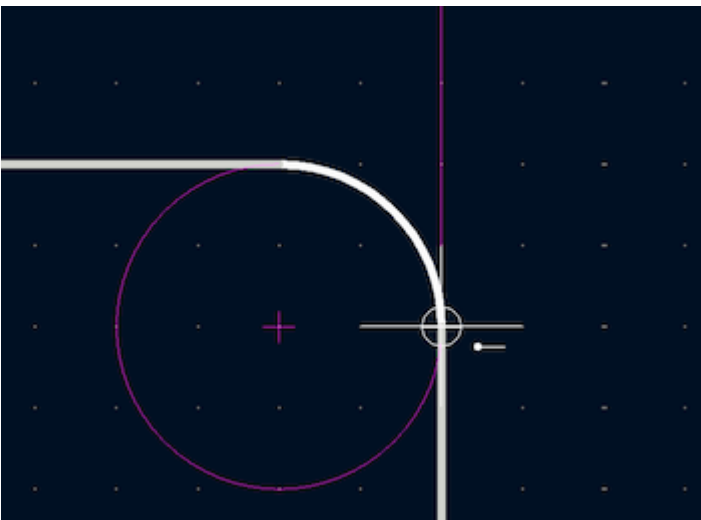

If you move the cursor away from the snapping point, a horizontal or vertical dashed line will appear, depending on the direction of motion. This indicates a horizontal or vertical projection from the snapping point, respectively. Following the line will maintain a position that is horizontally or vertically aligned to the original snap point. This projection is shown as a purple dashed line in the screenshot below.

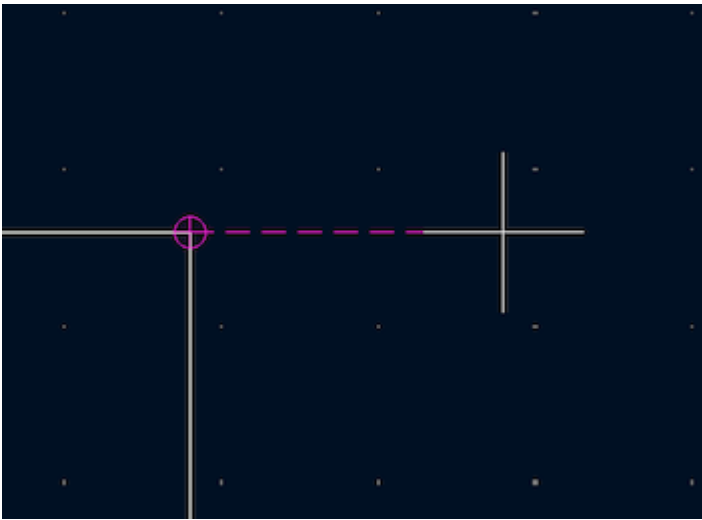

Grid settings

Interactive editing operations are snapped to the active grid. You can adjust the grid size using the grid dropdown in the top toolbar or by right-clicking and selecting a new grid from the list in the **Grid** submenu. Pressing the **n** or **N** hotkeys will cycle to the next and previous grid in the list, respectively.

You can also select a new grid or edit the available grids in the **Grids** pane of the preferences dialog. As a shortcut to reach this dialog, right click the  button on the left toolbar and select **Edit Grids...**

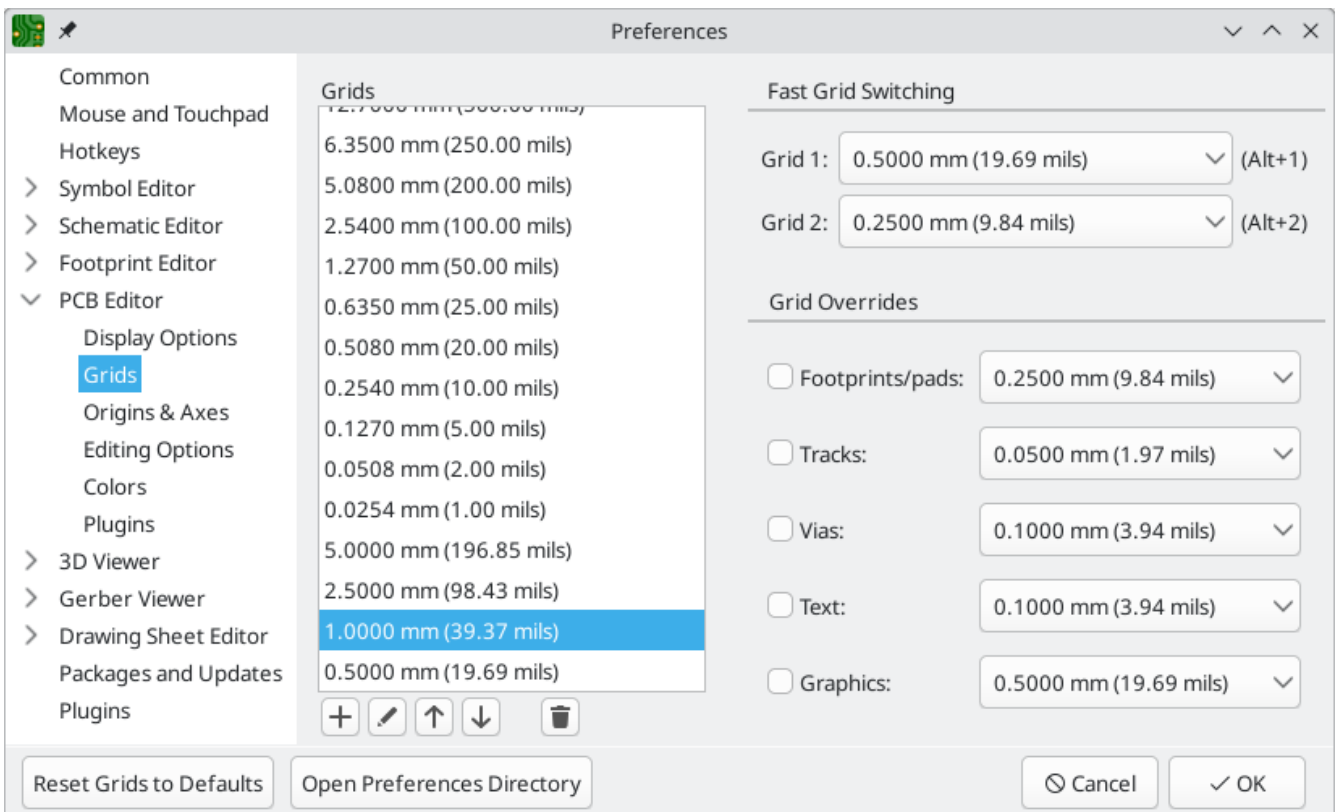

In this dialog you can select an active grid from the list of grids, reorder the list of grids (**↑** / **↓**), and add (**+**), remove (**🗑**), or edit (**✎**) grids. Grids defined in this dialog can have unequal X and Y spacing as well as an optional name. The grid spacing and name are specified when you create or edit a grid.

This dialog also lets you designate two grids from the list as "Fast Grids", which can be quickly selected using **Alt + 1** and **Alt + 2**.

Finally, you can configure grid overrides for different types of objects. Grid overrides let you set particular grid sizes for different types of objects which will be used instead of the default grid when working with those objects. For example, you can set a 100 mil grid for footprints and pads while using smaller grids to finely position tracks, vias, and text. Grid overrides can be individually enabled and disabled in this dialog, or globally enabled and disabled using the  button on the left toolbar (**Ctrl** + **Shift** + **G**).

To change the origin (zero point) of the grid, use **Place** → **Grid Origin** and click to place the origin in the canvas. This function is also available with the  button in the right toolbar. Alternatively, you can enter explicit coordinates for the grid origin with **Edit** → **Grid Origin....**

NOTE

The grid origin is one of several different origins in KiCad, which aren't necessarily set to the same point. The grid origin is the point that the grid aligns to; shifting the grid origin also shifts every grid point. The page origin is an absolute origin which is always the top left corner of the drawing sheet. The drill/place file origin is a configurable point that can be used for fabrication outputs (**Place** → **Drill/Place File Origin**). Finally, the local origin is a quickly settable relative origin that current cursor location by pressing ; the cursor coordinates relative to the local origin are displayed in the status bar.

The visual appearance of the grid can also be customized in several ways. You can change the thickness of the grid markings, switch their shape (dots, lines, or crosses), and set the minimum displayed spacing in the **Display Options** page of the preferences dialog, and you can change the grid color in the **Colors** page of the preferences dialog.

The grid can be shown or hidden using the  button on the left-hand toolbar. By default the grid is still active even if it is hidden, but this is configurable in the **Display Options** preferences page. There you can set the grid to be disabled when it is hidden or even disable the grid entirely.

编辑对象属性

All objects have properties that are editable in a dialog. Use the hotkey  or select **Properties** from the right-click context menu to edit the properties of selected item(s). You can only open the properties dialog if all the items you have selected are of the same type. For many object types, like footprints, you can only edit the properties of a single item at one time. To edit the properties of multiple items at once, including items with different types, you can use the Properties Manager.

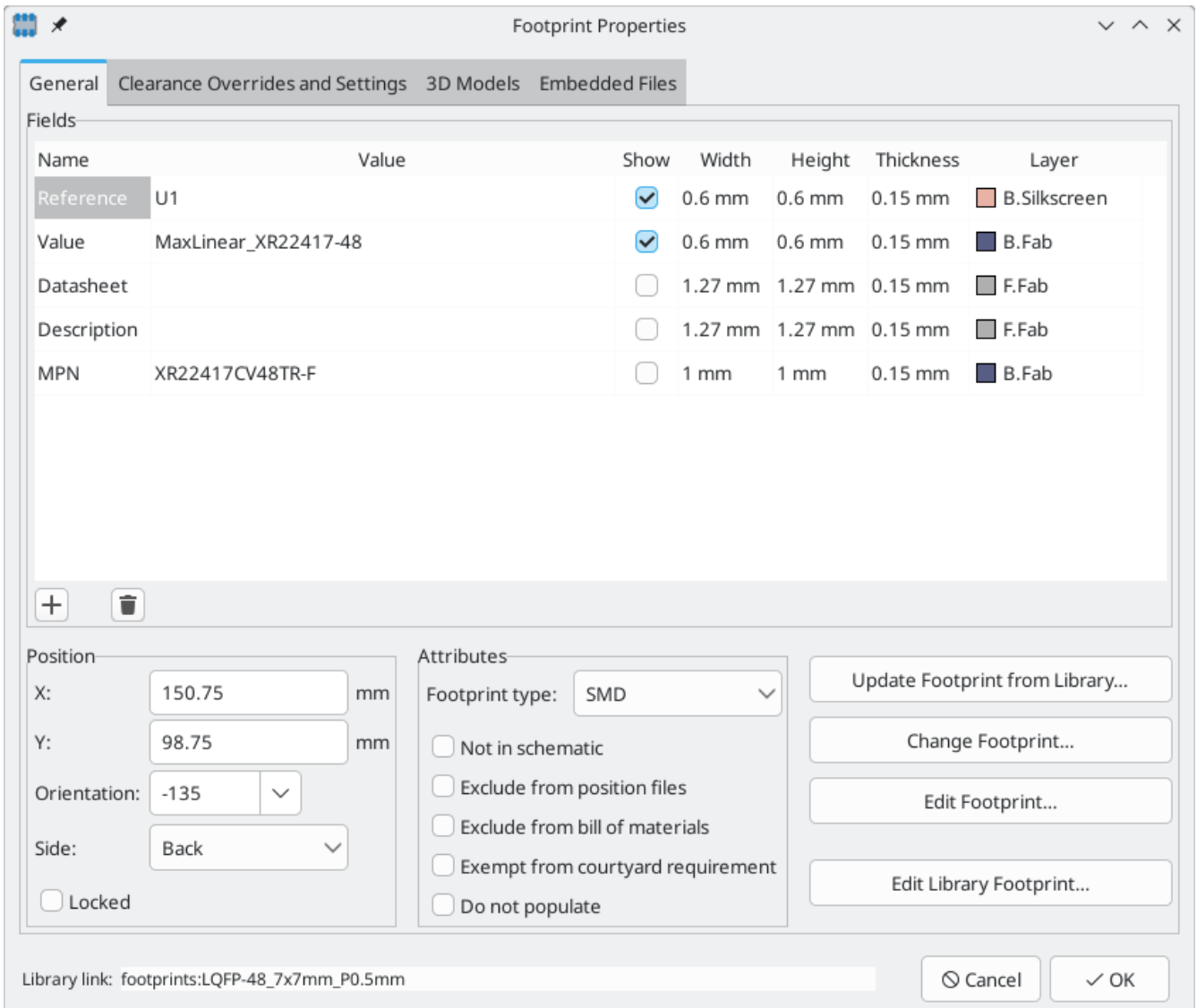

You can also view and edit item properties using the Properties Manager. The Properties Manager is a docked panel that displays the properties of the selected item or items for editing. If multiple types of items are selected at once, the properties panel displays only the properties shared by all of the selected item types.

Properties

Footprint

Basic Properties

Position X	150.75 mm
Position Y	98.75 mm
Locked	<input type="checkbox"/>
Layer	B.Cu
Orientation	-135°

Fields

Reference	U1
Value	MaxLinear_XR22417-48
Library Link	footprints:LQFP-48_7x7mm_P0.5mm
Library Description	LQFP, 48 Pin (https://www.analog.com/me)
Keywords	LQFP QFP
Component Class	

Attributes

Not in Schematic	<input type="checkbox"/>
Exclude From Position Files	<input type="checkbox"/>
Exclude From Bill of Materials	<input type="checkbox"/>
Do not Populate	<input type="checkbox"/>

Overrides

Exempt From Courtyard Requirement	<input type="checkbox"/>
Clearance Override	
Solderpaste Margin Override	
Solderpaste Margin Ratio Override	-0.125
Zone Connection Style	Inherited



Editing a property in the Properties Manager immediately applies the change. When multiple items are selected, property modifications are applied to each selected item individually, not to the whole selection as a group. For example, when changing the orientation of multiple items, each item is individually rotated around its own origin, not the group's origin.

Show the Properties Manager with **View** → **Panels** → **Properties** or the  button on the left toolbar.

Several tools are available for editing properties of specific types of objects in bulk. For text and graphical items, you can use the [Edit Text and Graphics Properties tool](#). Tracks and vias can be bulk-edited using the [Edit Track and Via Properties tool](#). Teardrop properties can be edited with the [Edit Teardrops tool](#).

In properties dialogs and many other dialogs, any field that contains a numeric value can also accept a basic math expression that results in a numeric value.

For example, a dimension may be entered as `2 * 2mm`, resulting in a value of `4mm`. Basic arithmetic operators as well as parentheses for defining order of operations are supported.

电路板边框 (Edge Cuts)

KiCad 使用 `Edge.Cuts` 层上的图形对象来定义电路板的边框。边框必须是一个连续（封闭）的形状，但可以由不同类型的图形对象组成，如直线和弧，或者是一个单一的对象，如矩形或多边形。如果没有定义电路板的边框，或者电路板的边框无效，那么一些功能，如 3D 查看器和一些设计规则的检查将无法发挥作用。

使用封装

Adding footprints to the board

Footprints are automatically added to the board when the PCB is [updated from the schematic](#). The footprint associated with each schematic symbol is added to the board if it is not already present, and each footprint pad is associated with the corresponding symbol pin's net. Symbol pins are matched to footprint pads by pin/pad number.

When footprints are added to the board after an update from the schematic, they are clustered by schematic sheet and by geographical location in the schematic. They are initially attached to the cursor; you can place them by clicking in the desired location.

You can also add footprints to the board manually using the [Add Footprint tool](#) ( or the  button).

NOTE

Footprints added in this way will not be automatically associated with a symbol or have nets assigned to their pads, and subsequent updates from the schematic will remove these unassociated footprints unless the footprint is locked or the **Delete footprints with no symbols** option is unchecked in the Update PCB From Schematic dialog. For these reasons, it is usually recommended to avoid manually adding footprints to the board. Manually adding footprints is necessary for [PCB-only workflows](#), and can also be useful for adding logos or other footprints that do not need a corresponding schematic symbol.

Placing and moving footprints

Once footprints have been added to the board, you can reposition them in many ways.

The Move command () moves a footprint or a selection of footprints, ignoring any connected track segments that are not selected. No DRC checking is done when moving footprints with the Move command, although any footprint courtyards that collide with the moved footprint's courtyard will be highlighted.

There is a reference point for the move operation, which is the point in the footprint which attaches to the cursor and therefore the point in the footprint that snaps to the grid and to other objects. The reference point during a move is determined by the location of the cursor when the Move command is initiated. If the cursor is over a pad, the pad's center will be used as the reference point. If the cursor is not over a pad, the footprint's anchor (coordinate origin point) will be used. To select an arbitrary snapping point, you can use the Move With Reference command instead of the regular Move command (right click → **Positioning Tools** → **Move with Reference**). After initiating the command, click on the desired reference point; KiCad will then begin the move with that point as the reference.

You can also use the Drag command () to move the selected footprint using the interactive router, maintaining all track connections to the footprint. Dragging footprints behaves like the Highlight Collisions router mode: obstacles will not be avoided or shoved, only highlighted. Ordinarily the router will prevent

you from dragging a footprint into a position that violates DRC: when you click to commit a drag in a position that violates DRC, the footprint will return to its original position. To force a drag to be committed even if it violates DRC, **Ctrl**-click to commit the drag. Like the Move command, colliding courtyards are highlighted.

NOTE

Only tracks that end at the origin of the footprint's pads will be dragged. Tracks that simply pass through the pad or that end on the pad at a location other than the origin will not be dragged.

You can move a footprint to the opposite side of the board with the Flip command (**F**). Any parts of the footprint on a front layer will be swapped to the corresponding back layer, and vice versa.

Footprints can be rotated counter-clockwise using the **R** hotkey, or clockwise using **Shift** + **R**. By default, footprints are rotated by 90 degrees every time the rotate command is used, but you can configure the rotation angle step in **Preferences** → **PCB Editor** → **Editing Options**.

You can directly set a footprint's exact absolute position, rotation angle, and PCB side using either the Footprint Properties dialog or the Properties panel.

To reposition a footprint relative to its current position, use the Move Exactly tool (**Shift** + **M**). The dialog lets you specify an X and Y translation, as well as a rotation, that will be applied to the footprint. The rotation can be performed relative to either the footprint's anchor, the local coordinate origin, or the drill/place origin. You can also use polar coordinates instead of Cartesian coordinates.

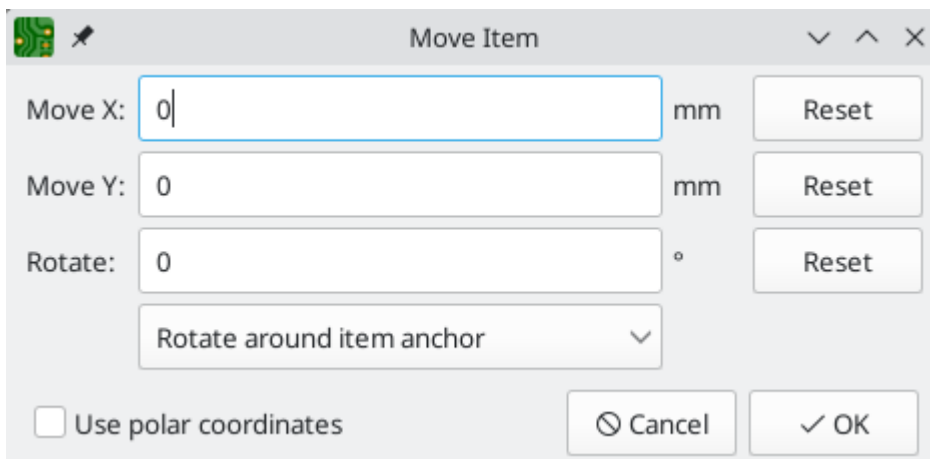

To position a footprint relative to another object, you can use the Position Relative tool (**Shift** + **P**). With this tool, you select a reference point for the move and specify an offset. The footprint is moved to the specified offset relative to the reference point. The reference point can be one of the following:

- The local origin, which is set to the cursor position when you press **Space**.
- The grid origin, which is configured in the Grids dialog.
- The location of an arbitrary item on the board, such as a specific pad in a footprint. After clicking the **Select Item...** button, click on the desired board item in the canvas to set the reference point.
- An arbitrary point in the canvas. After clicking the **Select Point...** button, click at the desired location to set the reference point. You can use object snapping to select a specific point in an object, such as the end of a graphic line.

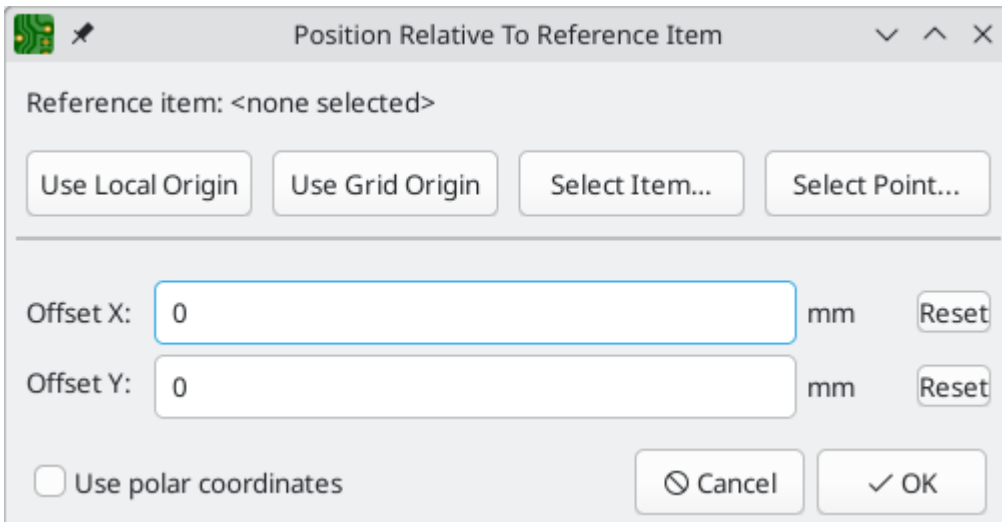

To position a footprint such that an arbitrary point in the footprint is positioned a certain distance from another arbitrary reference point, you can use the Position Interactively tool (right click a footprint → **Positioning Tools** → **Position Interactively...**).

This tool lets you interactively select two points that form the start and end of a position vector. The first point is a reference point in the footprint, and will move along with the footprint. The second point is a fixed reference that will remain stationary when the footprint is moved. The vector from the first point to the second point is shown graphically in the editing canvas. You can then give new X and Y (or polar) dimensions for the vector, which will move the footprint reference relative to the fixed reference such that the fixed reference is the specified distance from the footprint reference point. The dialog initially contains the vector dimensions before any move is performed, or in other words the initial distance between the footprint reference point to the fixed reference.

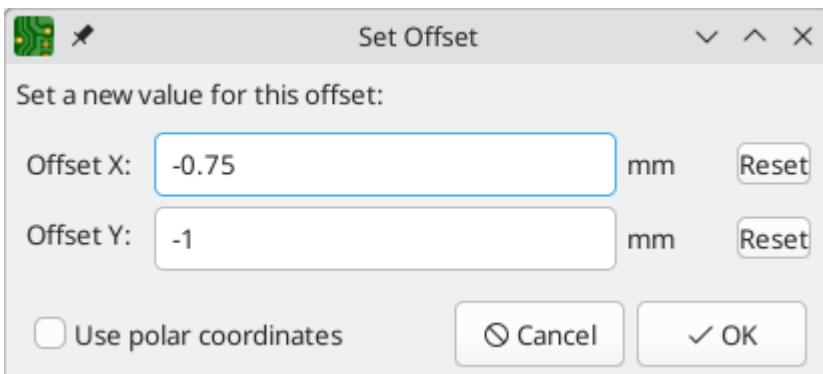

You can swap the position of two selected footprints using the Swap command (**S**). The first footprint is assigned the location, rotation, and board side of the second footprint, and vice versa. If there are more than two footprints selected, the locations are cycled: the last footprint gets the position of the first footprint, the first footprint gets the location of the second, and so on.

There are several convenience features that make it easier to find, select, and move specific footprints or footprints related to another footprint.

The Get and Move Footprint command (**T**) prompts you to choose a footprint from a list or by typing a reference designator. KiCad then attaches the chosen footprint to your cursor for a move operation.

There are two commands to select other footprints that need to be connected to the selected footprint but don't yet have routed connections. The Select All Unconnected Footprints command (**U**) selects all

footprints that have ratsnest lines to the currently selected footprints. The command can be executed repeatedly to further expand the selection based on the newly selected items. The Grab Nearest Unconnected Footprint command (**Shift** + **U**) selects the closest footprint with ratsnest lines to the currently selected footprint, and additionally begins to move it. If there are multiple footprints initially selected, the command will act like the Move Individually command described below, individually moving the closest unconnected footprint for each of the initially selected footprints.

You can select footprints based on their schematic sheet using the right click → **Select** → **Items in Same Hierarchical Sheet** command, which selects all other footprints that are in the same schematic sheet as the originally selected footprint.

If you want to move multiple selected footprints in sequence, use the Move Individually command (**Ctrl** + **M**). After triggering the command, KiCad will begin moving the first selected footprint. After you click to place the footprint, KiCad will immediately start moving the next footprint, in the same order that you selected the footprints. You can skip moving a footprint by pressing **Tab**, commit the current move and skip any remaining moves by double-clicking, or cancel all moves (including those already completed) by pressing **Esc**.

If you want to move a collection of footprints at once into one area, the Pack and Move Footprints command (**P**) closely packs the selected footprints together and moves them as a block.

TIP

Move Individually and Pack and Move Footprints are useful in combination with other selection convenience features, such as cross-selection from the schematic or the advanced footprint selection features described above. For example, you could select a group of bypass capacitors in the Schematic Editor, switch to the PCB Editor where the corresponding footprints are now selected, and then use Move Individually to quickly place all of the bypass capacitor footprints close to their respective ICs. Alternatively, you could use one of the other selection tools, such as Select All Unconnected Footprints, to select many footprints from all over the board, then use Pack and Move Footprints to quickly put them all into a small area.

Finally, KiCad can automatically place footprints onto the board. The auto-place function attempts to optimally place footprints to simplify ratsnest connections to other footprints. You can auto-place the selected footprints with **Place** → **Auto-Place Footprints** → **Place Selected Footprints**, or auto-place all footprints outside of the board outline with **Place** → **Auto-Place Footprints** → **Place Off-Board Footprints**.

Editing Footprints

Footprints in the board can be individually edited, both in terms of their properties (fields, attributes, clearance settings, etc.) and in terms of their physical pads and graphics. Editing a footprint in the board only affects that particular instance of the footprint; it does not affect any other copies of that footprint in the board, and it does not affect the library footprint.

To edit the properties of a footprint in the board, open its properties dialog (**E**)

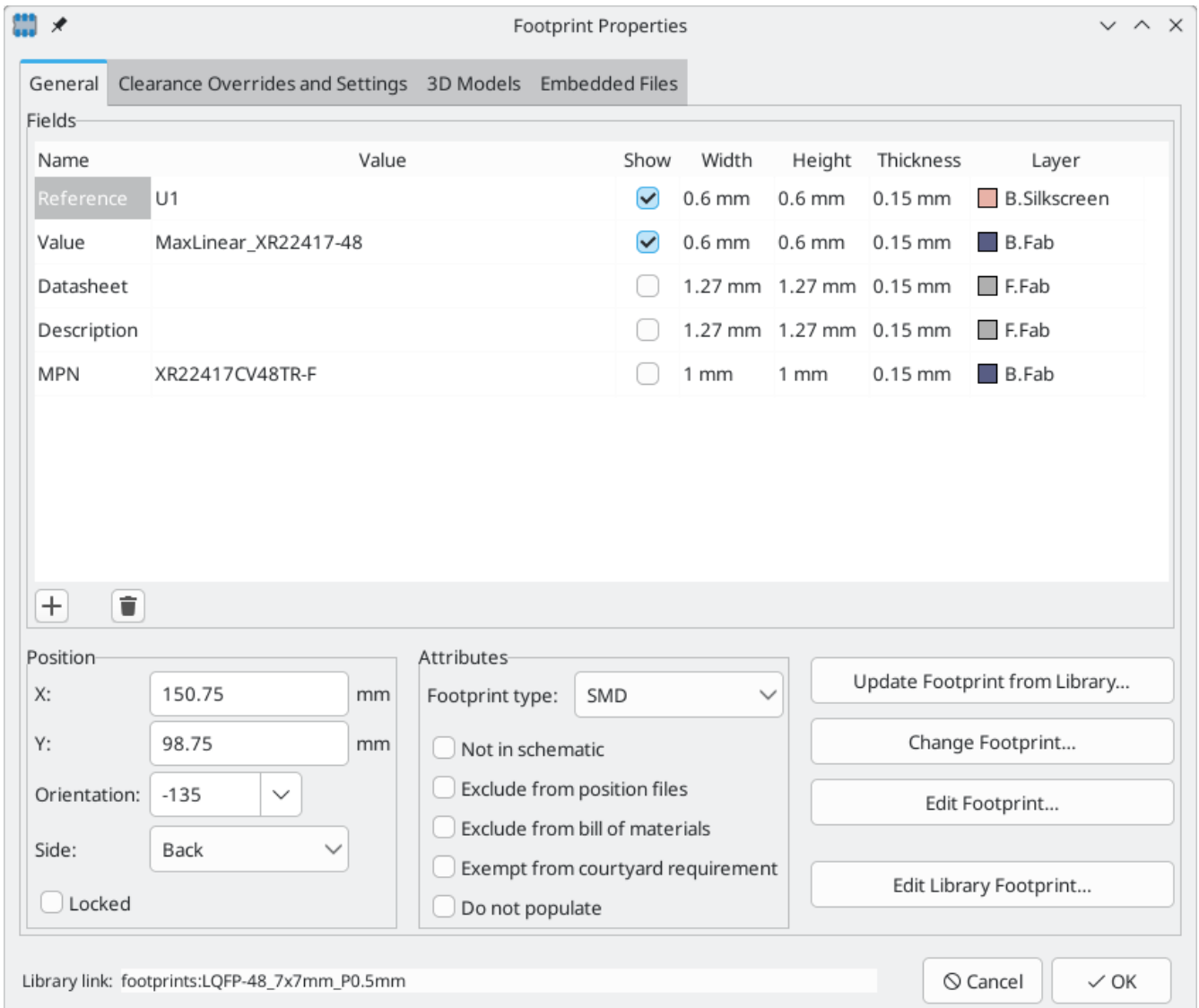

The majority of the settings in this dialog are the same as in the [footprint editor](#). You can edit the footprint's fields, attributes, clearance and zone connection settings, 3D models, and [embedded files](#), as in the footprint editor. However, here you can also set the footprint's position, orientation, and side. You can also update the footprint from the library, exchange it for a different footprint, or edit the footprint itself in the footprint editor.

To edit the footprint's physical form, i.e. its pads and graphics, you need to use the [footprint editor](#). There are two buttons for opening a footprint in the editor, depending on whether you want to edit a single copy of a footprint in the board or a footprint's source copy in the library.

- **Edit Footprint...** will open the specific instance of the footprint in the footprint editor. Editing this footprint will only affect this one instance of the footprint in the board. It will not affect other instances of the footprint in the board, and it will not affect the library copy of the footprint. You can also open a board footprint in the footprint editor by right clicking the footprint in the board and selecting **Open in footprint editor** (**Ctrl** + **E**).
- **Edit Library Footprint...** will open the library copy of the footprint in the footprint editor. Editing the library copy of the footprint will edit the footprint in the footprint library, but will not immediately affect any instances of that footprint in the board. To update footprints in the board with changes to the library footprint, use the **Update Footprint from Library...** tool. Editing the library footprint in this way

is equivalent to opening the footprint editor, opening the appropriate footprint in its library, and editing it.

The **Update Footprint from Library...** button is used to update the board's copy of the footprint to match the copy in the library. The **Change Footprint...** button is used to swap the current footprint to a different footprint in the library. These functions are described [later](#).

Editing footprint fields

An individual symbol text field can be edited directly with the **E** hotkey (with a field selected instead of a footprint) or by double-clicking on the field.

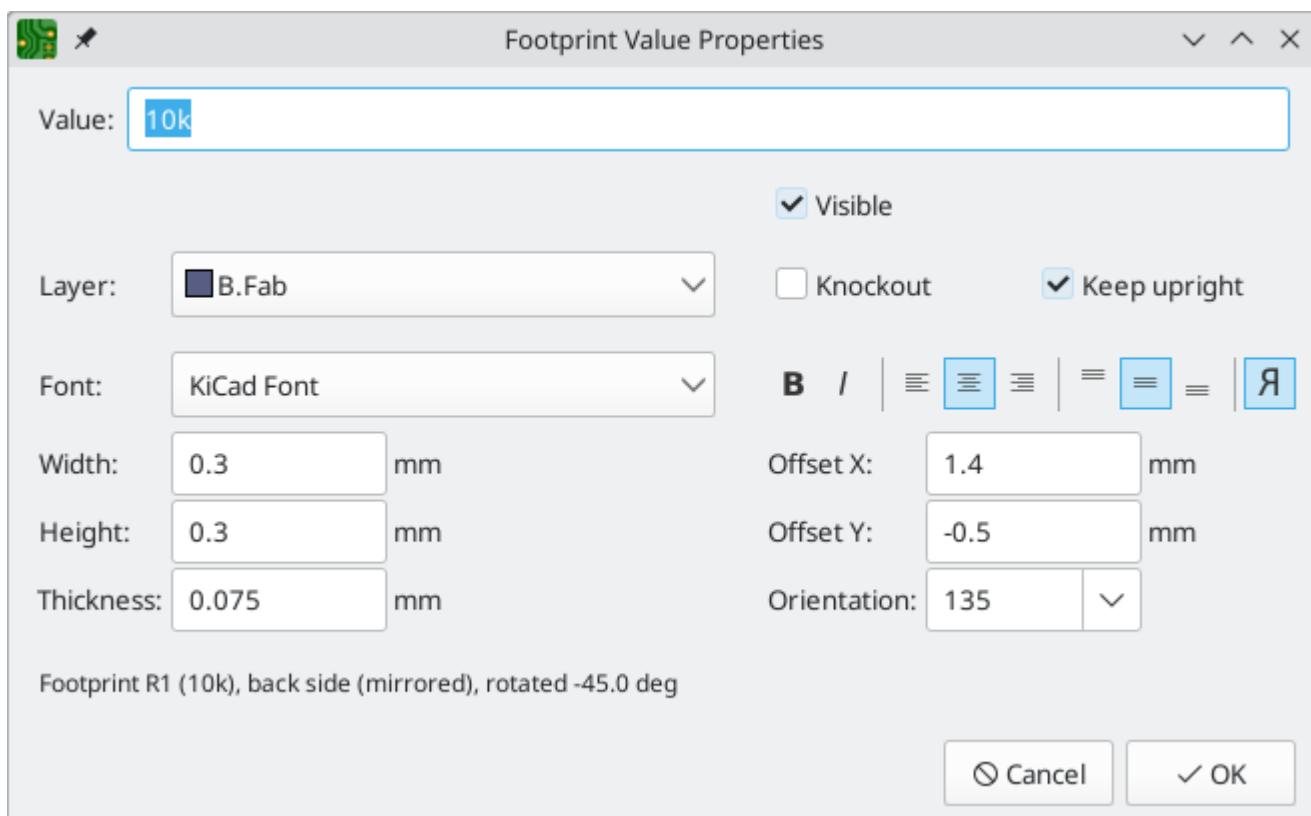

The options in this dialog are the same as those in the full Footprint Properties dialog, but are specific to a single field.

Only footprint fields can be edited this way in the board editor. Unlike fields, Footprint text is a graphic object that can only be edited or moved in the footprint editor.

NOTE

In versions of KiCad before version 8.0, footprint fields did not exist. Instead, footprint text could be edited directly in the board editor. In KiCad 8.0, footprint text is not editable in the board editor and can only be edited in the footprint editor.

Updating and exchanging footprints

When a footprint is added to the board, KiCad embeds a copy of the library footprint in the board so that the board is independent of the system libraries. Footprints that have been added to the board are not automatically updated when the library changes. Library footprint changes are manually synced to the board so that the board does not change unexpectedly.

NOTE

You can use the [Compare Footprint with Library tool](#) to inspect the differences between a footprint in a board with its corresponding library footprint.

To update footprints in the board to match the corresponding library footprint, use **Tools** → **Update Footprints from Library...**, or right click a footprint and select **Update Footprint...** You can also access the tool from the [footprint properties dialog](#).

Update Footprints from Library

Update all footprints on board

Update selected footprint(s)

Update footprints matching reference designator: U301

Update footprints matching value: XCR3256-TQ144

Update footprints with library id: Package_QFP:TQFP-144_20x20mm_P0.5mm

Update Options

Remove text items which are not in library footprint

Update/reset text layers and visibilities

Update/reset text sizes, styles and positions

Update/reset text content

Update/reset fabrication attributes

Update/reset 3D models

Output Messages

Show: All Errors 0 Warnings 0 Actions Infos Save...

Close Update

The top of the dialog has options to choose which footprints will be updated. You can update all footprints on the board, update only the selected footprints, or update only the footprints that match a specific reference designator, value, or library identifier. The reference designator and value fields support wildcards: ***** matches any number of any characters, including none, and **?** matches any single character.

The middle of the dialog has options to control what parts of the footprint will be updated. You can select specific fields to update or not update, which properties of the fields to update (text content, visibility, size and style, and position), and how to handle fields that are missing or empty in the library footprint. You can

also choose whether to update footprint attributes, such as footprint type, **not in schematic**, **exclude from position files** / **bill of materials**, **exempt from courtyard requirement**, and **do not populate**.

The bottom of the dialog displays messages describing the update actions that have been performed.

To change an existing footprint to a different footprint, use **Edit** → **Change Footprints...**, or right click an existing footprint and select **Change Footprint...**. This dialog is also accessible from the [footprint properties dialog](#).

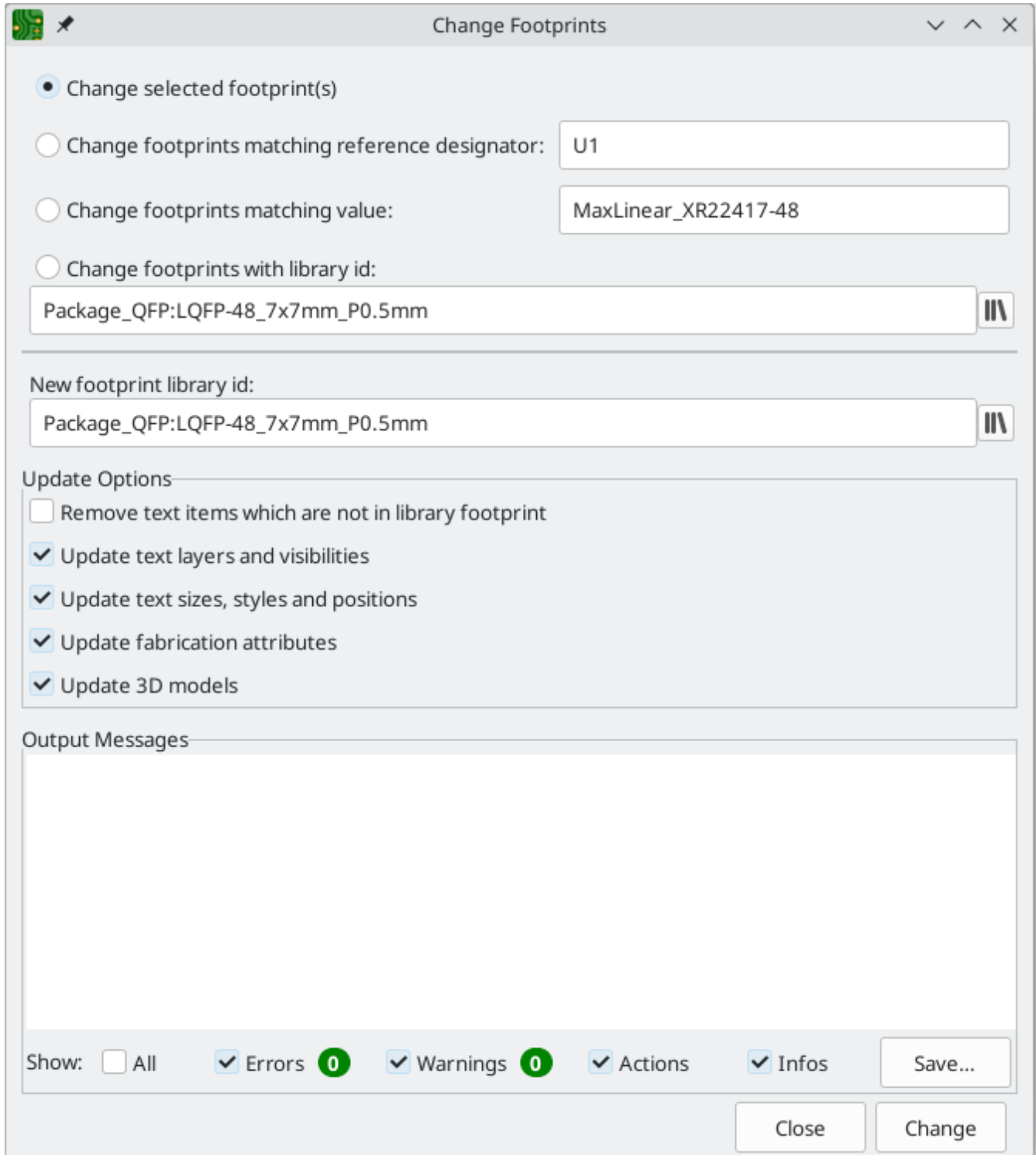

The options for the Change Footprints dialog are very similar to the Update Footprints from Library dialog.

Comparing footprints between board and library

When a footprint in a board diverges from the corresponding footprint in the original footprint library, you can use the Compare Footprint with Library tool to inspect the differences between the two versions of the footprint. Run the tool using **Inspect** → **Compare Footprint With Library**.

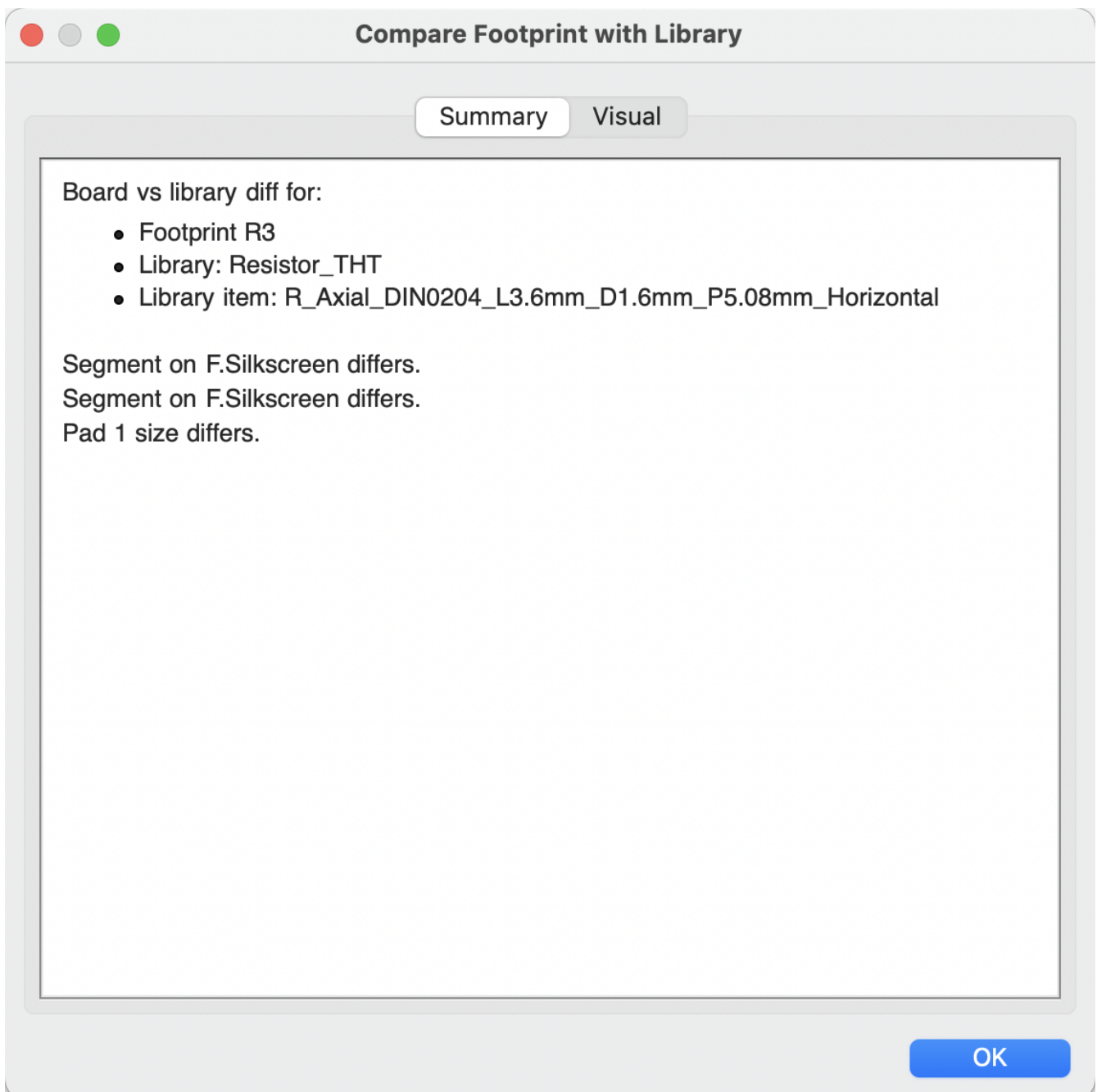

The **Summary** tab shows the name of the footprint, including its library and board reference designator, and provides a list of the differences between the board and library versions of the footprint.

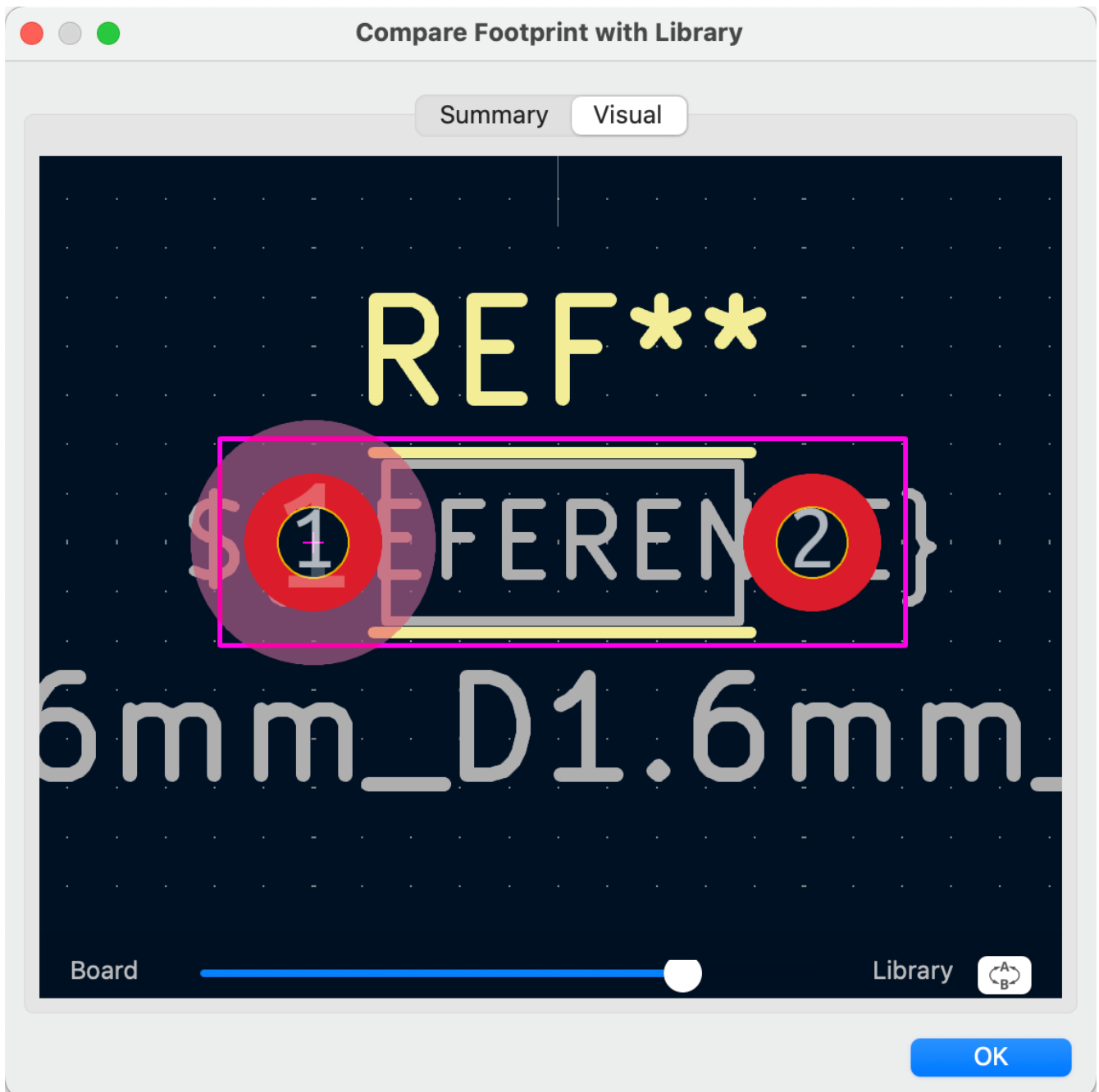

The **Visual** tab shows a visual comparison of the board and library versions of the footprint. This can be used as a visual diff tool.

By default, the comparison displays both versions of the footprint superimposed on each other. To see the changes more easily, you can drag the slider at the bottom of the tab to the right to emphasize the library version of the footprint in the superimposed view (making the board version of the footprint more transparent) or drag it to the left to emphasize the board version (making the library version more transparent). At the far right and left ends of the slider, the board and library versions of the footprint, respectively, are fully hidden. It may be helpful to drag the slider back and forth to see the changes more clearly.

You can press the **A/B** button, or use the  hotkey, to quickly toggle back and forth between the board and library versions.

The screenshot above shows a visual comparison with the board version of the footprint deemphasized. Looking at pad 1 on the left, you can see a large, partially transparent pad (from the board footprint)

surrounding a fully opaque, smaller pad (from the library footprint). This indicates that the pad was enlarged in the board version of the footprint, or shrunk in the library version of the footprint.

使用焊盘

在将封装放置在电路板上之后，可以检查和编辑封装的每个单独的焊盘的属性。换句话说，如果库中的封装设计不合适，就可以在电路板上封装的特定实例中覆盖单个封装焊盘的设计。例如，你可能希望为一个需要在特定设计中保持不焊接的焊盘去除锡膏孔，或者你可能希望移动一个轴向引线电阻的通孔焊盘的位置，以适应特定的设计。

NOTE

默认情况下，所有封装焊盘的位置都被锁定，因此可以编辑焊盘属性，但不能移动焊盘相对于封装其他部分的位置。焊盘可以被解锁以允许自由移动，这对某些应用很有用（如具有不同引线位置的通孔封装），但通常不建议用于表面贴装封装。

当一个焊盘被选中时，焊盘属性对话框将通过上下文菜单或默认的快捷键 **E** 打开。请注意，KiCad 认为如果你在焊盘附近点击，你可能是想选择整个封装而不是单个焊盘。要选择单个焊盘，请确保在焊盘区域内点击，或者关闭选择过滤器中的“封装”设置（并确保“焊盘”设置打开），以防止意外地选择整个封装而不是特定的焊盘。

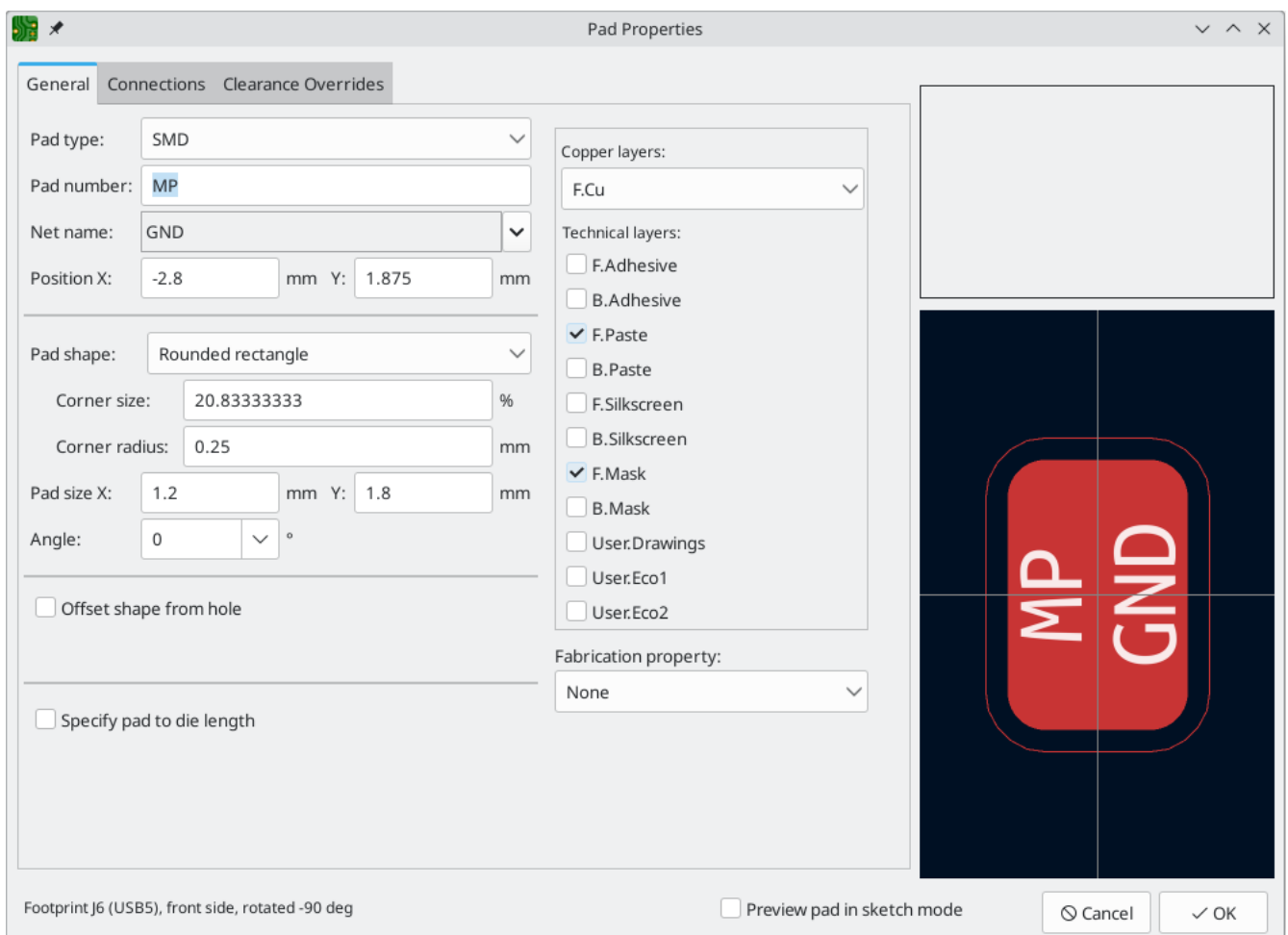

This dialog lets you edit the physical properties of the pad, including size and shape. You can also modify how the pad connects to other objects on the board, including clearance properties, teardrops, and thermal reliefs.

This dialog is the same as the pad properties dialog in the footprint editor, except that here you can also manually assign a net to a pad using the **net name** selector. The remaining options are explained in the [Footprint Editor documentation](#).

NOTE

While you can manually assign nets to pads in the PCB editor, this is not a typical workflow. Usually net-to-pad connections are defined by the schematic and then [transferred to the PCB editor](#).

使用敷铜

敷铜区域，有时也被其他 EDA 工具称为铺铜或覆铜，是分配给一个特定网络的实心或网格状的铜箔区域，敷铜区域会自动保持与其他铜对象的间隙。敷铜区域通常用于填充板层（或板层的一部分）上的所有自由空间，以创建接地和电源平面，承载大电流，或提供屏蔽。

NOTE

一些 EDA 工具有单独的工具用于创建“平面层”及在信号层上创建敷铜区域。在 KiCad 中，敷铜工具用于这两种应用。

区域是由一个多边形的 **边框** 来定义的，它定义了敷铜区域的最大范围。这个边框并不代表实物铜，也不会出现在导出的制造数据中。每次修改边框或边框内的任何对象时，必须 **填充** 该敷铜区域。填充过程可以在单个敷铜区域上运行，也可以在电路板的所有区域上运行（默认快捷键 **B**）。敷铜区域可以 **不填充**（默认快捷键 **Ctrl + B**），以提高性能并减少编辑大型电路板时的视觉混乱。

NOTE

By default, zone filling is a manual process rather than occurring every time an object changes that would result in a change to the zone copper. This is because zone filling can be a slow process on older computers or very large designs. It is important to make sure zone fills are up-to-date before generating outputs. KiCad will check that zones have been updated and warn you before generating outputs or running DRC when zones have not yet been refilled. You can optionally enable automatic zone-filling in the Preferences dialog (**PCB Editor** → **Editing Options** → **Miscellaneous** → **Automatically refill zones**).

要绘制一个敷铜区域，请点击右侧工具栏的“添加敷铜区域”工具（），或者使用默认的快捷键 **Ctrl + Shift + Z**。点击选择敷铜区域边框的第一个点。敷铜区域属性对话框将出现，允许你选择敷铜区域的网络和其他属性。这些属性可以在任何时候进行编辑，所以一开始正确选择它们并不是关键。接受该对话框，继续放置点来定义敷铜区域的边框。要完成这个区域，请双击来设置最后一个点。敷铜区域边框点可以像图形多边形一样进行修改，通过拖动方形手柄来移动一个角，或者拖动圆形手柄来移动一条边。要编辑该敷铜区域的属性，请使用快捷键 **E** 或从上下文菜单中选择“属性”。

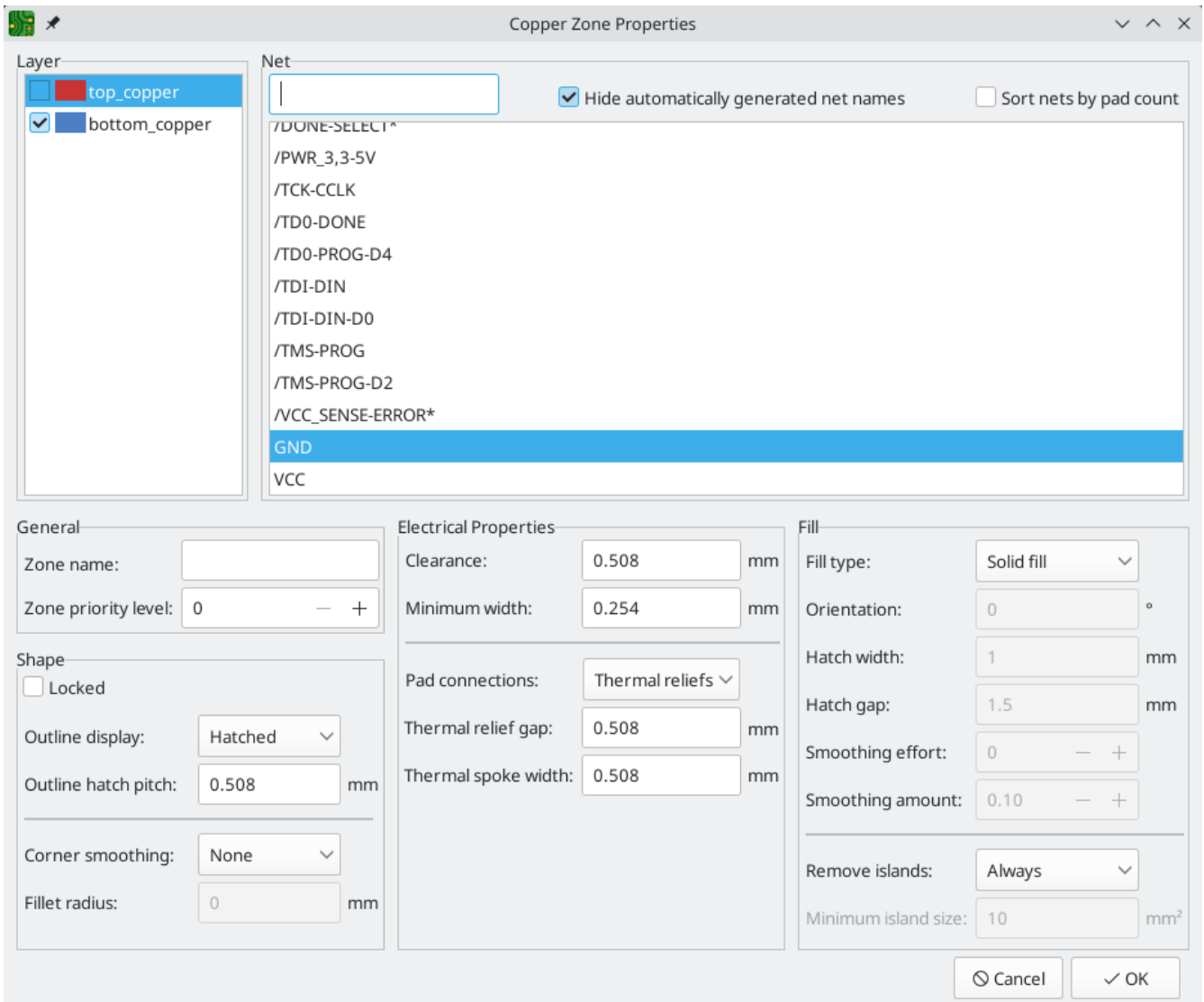

Layer: A single zone object can create filled copper on one or more copper layers. Check the box next to each copper layer that this zone outline should fill on. The copper on each layer will be filled independently, but all layers will share the same net.

Net: Select the electrical net that the zone copper should be connected to. It is possible to create zones with no net assignment. Zones with no net will keep clearance from any copper objects on any net.

Zone name can be used to assign a specific name to a zone. This name can be used to refer to the zone in custom DRC rules.

Zone priority level determines the order in which multiple zones on a single layer are filled. The highest priority level zone on a given layer will be filled first. Lower-priority zones will keep clearance to the filled areas of higher-priority zones. Two zones on the same layer with the same priority level will overlap (short-circuit) with each other, unless they are assigned different nets. When two zone outlines with the same priority and different nets touch, one zone will maintain clearance to the other so that they don't short.

Locked controls whether or not the zone outline object is **locked**. Locked objects may not be manipulated or moved, and cannot be selected unless the **Locked Items** option is enabled in the Selection Filter panel.

Outline display controls how the zone outline is drawn on screen. In **Line** mode, only the border lines of the outline are drawn. In **Hatched** mode, hatch lines are drawn on the inside of the outline border for a

short distance, to make the zone outline more apparent. In **Fully Hatched** mode, hatch lines are drawn across the entire inside of the zone outline.

Corner smoothing controls the behavior of the filled copper areas at corners of the outline. Corners can be smoothed by a chamfer or fillet, or can extend all the way to the outline corner if smoothing is disabled. The chamfer or fillet size is configurable when those modes are selected.

NOTE

默认情况下，倒角和圆角不会被添加到区域边框的**内角**，因为这将导致填充的铜延伸到边框之外。如果需要光滑的内角，请在电路板设置对话框的约束部分启用**允许敷铜区域边框外的圆角**选项。

Clearance controls the minimum clearance the filled areas of this zone will keep from other copper objects. Note that if two clearance values are in conflict, the larger clearance value will be used. For example, if a zone is set to use 0.2mm clearance but its netclass is set to use 0.3mm clearance, the result will be an 0.3mm clearance.

Minimum width controls the minimum size of narrow necks of copper created inside the zone. Any copper areas that would be below this minimum width are removed during the filling process.

Pad connection controls the way that the filled zone areas will connect to footprint pads on the same net. **Solid** connections will result in the copper completely overlapping the pads. **Thermal reliefs** will result in small copper spokes connecting the pad to the rest of the copper zone, increasing the thermal resistance between the pad and the rest of the zone. This can be useful for hand soldering. **Reliefs for PTH** will apply thermal reliefs to plated through-hole pads and use solid connections for surface mount pads. **None** will result in the zone not connecting to any pads on the same net.

Thermal relief gap controls the distance maintained between any pad and the copper zone when the pad connection mode is set to generate thermal reliefs.

Thermal spoke width controls the width of the "spokes", or short copper segments connecting the pad to the rest of the copper zone.

Fill type controls how the copper zone is filled: the default is **solid fill**, which will result in copper filling in all available space within the zone outline. The zone can also be set to fill a **hatch pattern**, which will fill the area with a pattern that contains less copper. This can be useful for flexible printed circuits and other specialty applications.

Orientation controls the angle of the hatch pattern lines. An orientation of 0 degrees will result in the hatch pattern using horizontal and vertical lines.

Hatch width controls the width of each line in the hatch pattern.

Hatch gap controls the distance between each line in the hatch pattern.

Smoothing effort controls the style of smoothing applied to the hatch pattern. A value of 0 will result in no smoothing, and a value of 3 will result in the finest smoothing. Higher values will result in longer processing time and larger Gerber files.

Smoothing amount is a ratio that controls the size of the smoothing chamfers or fillets that are generated when **smoothing effort** is set to a value other than 0. An amount of 0.0 results in no smoothing, and a value of 1.0 results in maximum smoothing (in other words, a chamfer or fillet equal to half of the hatch gap).

Remove islands controls the behavior of isolated copper areas, also called islands, after the initial zone fill. When this is set to **always**, isolated areas inside the zone are removed. When set to **never**, isolated areas are left alone, and will result in copper areas that are not connected to the rest of the net. When set to **below area limit**, a **minimum island size** can be specified, and islands below this threshold will be removed.

NOTE

无论 **移除死铜** 设置如何，死铜都不会从没有电气连接的敷铜区域中移除。换句话说，仅可以从具有至少一个电气连接的敷铜中移除死铜。

Managing zones

Instead of editing a single zone with the Zone Properties dialog, you can use the Zone Manager tool to view, edit, and prioritize all zones in the board at once. To run the Zone Manager, click **Tools** → **Zone Manager**.

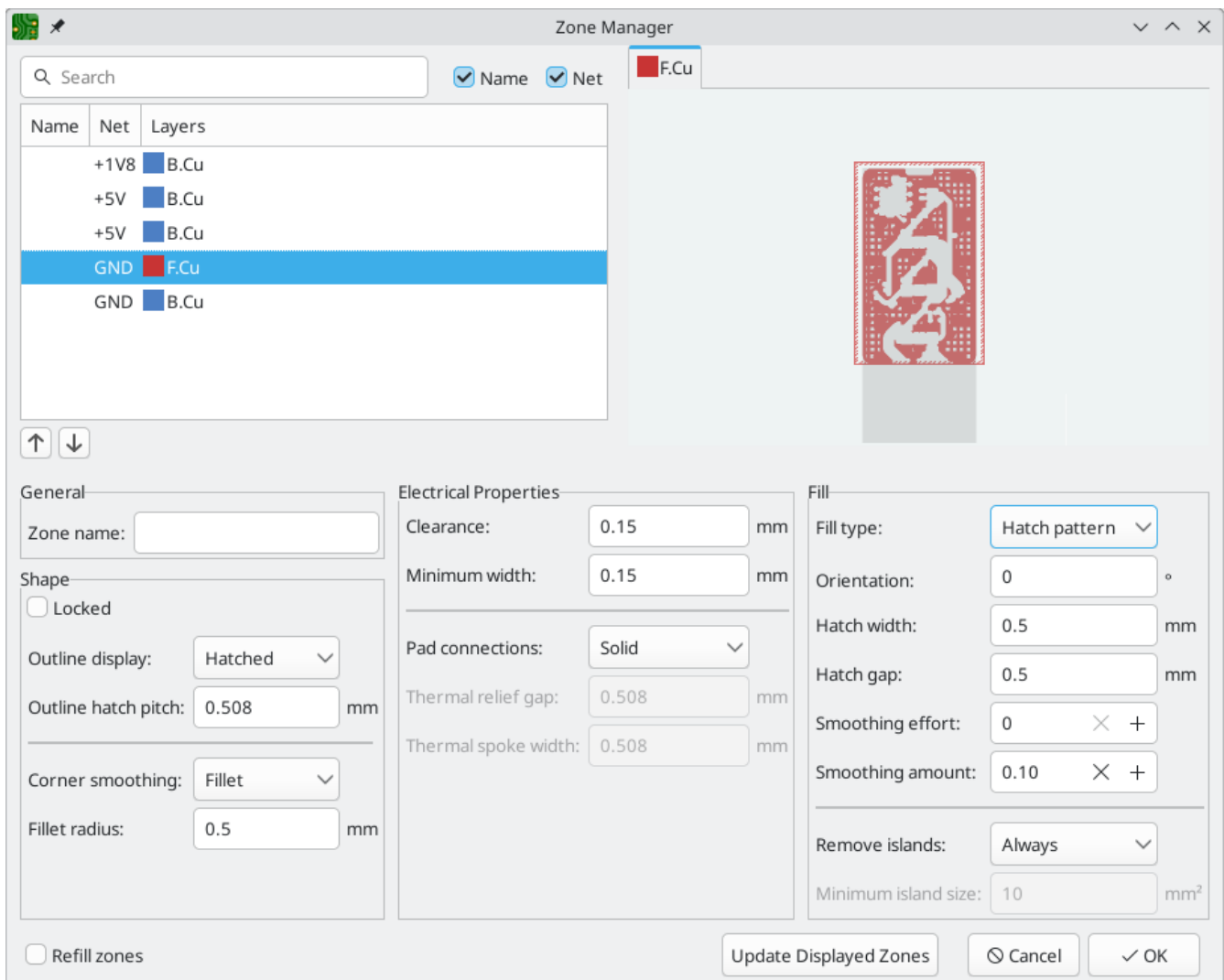

The top left of the dialog shows a list of all zones in the board, displaying the name (if any), net, and layers for each zone. The order of the zones in the list reflects the priority of each zone: higher priority zones are higher in the list. To change the priority of a zone, use the **↑** and **↓** buttons to move it up or down in the list. You can filter the list of zones by typing into the filter box. The filter matches against the zones' name and/or net, depending on which filter options are enabled.

Selecting a zone in the list shows a preview of that zone in the top right. If the selected zone spans multiple layers, each layer is shown individually. You can preview each layer by clicking the appropriate layer tab above the preview.

The bottom part of the dialog shows the settings for the selected zone, which are explained [above](#). You can preview the new settings by clicking the **Update Displayed Zones** button, which updates the zone preview without affecting the board. Changing the properties of a zone in the Zone Manager will not update the board until you press **OK**. If the **Refill zones** option is enabled, all zones will be refilled when you accept the dialog. If **Refill zones** is not enabled, zones will not be refilled until you manually refill them.

布线

KiCad 具有交互式布线器的功能：

- Allows manual or guided (semi-automatic) routing of single tracks and differential pairs
- 可通过以下方式修改现有设计：
 - 拖动已有导线时进行重新布线
 - 拖动封装时对连接到封装焊盘的导线进行重新布线
- 允许通过插入蛇形线 + 来调整布线长度和差分对的偏移（相位）为具有严格时序要求的设计调整布线形状

默认情况下，布线器在放置布线时遵循配置的设计规则：新布线的尺寸（宽度）将取自设计规则。在确定新布线和过孔的放置位置时，布线器将遵循设计规则中设置的铜间隙。如果需要的话，可以通过使用高亮冲突布线器模式，或打开布线器设置中的“允许 DRC 违规”选项来禁用这种行为（见下文）。

The router has three modes that can be selected at any time in the [Interactive Router Settings dialog](#). The router mode is used for routing new tracks, but also when dragging existing tracks using the Drag (hotkey **D**) command. These modes are:

- **Highlight Collisions:** in this mode, most of the router features are disabled and routing is fully manual. When routing, *collisions* (clearance violations) will be highlighted in green and the newly-routed tracks cannot be fixed in place if there is a collision unless the Allow DRC Violations option is turned on. In this mode, up to two track segments may be placed at a time (for example, one horizontal and one diagonal segment).
- **Shove:** in this mode, the track being routed will walk around obstacles that cannot be moved (for example, pads and locked tracks/vias) and *shove* obstacles that can be moved out of the way. The router prevents DRC violations in this mode: if there is no way to route to the cursor position that does not violate DRC, no new tracks will be created.
- **Walk Around:** in this mode, the router behaves the same as in Shove mode, except no obstacles will be moved out of the way.

Which mode to use is a matter of preference. For most users, we recommend using Shove mode for the most efficient routing experience or Walk Around mode if you do not want the router to modify tracks that are not being routed. Note that Shove and Walk Around modes always create horizontal, vertical, and 45-degree (H/V/45) track segments. If you need to route tracks with angles other than H/V/45, you must use Highlight Collisions mode and enable the Free Angle Mode option in the [Interactive Router Settings dialog](#).

There are four main routing functions: Route Single Track, Route Differential Pair, Tune length of a single track, and Tune skew of a differential pair. All of these are present in both the Route menu dropdown (individually) on the top toolbar and the drawing toolbar in two overloaded icons on the drawing toolbar on the right. The use of the overloaded icons is described above. One is for the two Route functions and one

is for the two Tune functions. In addition, the Route menu allows the selection of Set Layer Pair and Interactive Router Settings.

要进行布线布线，请点击布线  图标（从绘图工具栏或从顶部工具栏 **布线** 菜单中）或使用快捷键 **X**。点击一个起始位置，选择要布线的网络，并开始布线。布线的网络会自动高亮显示，网络允许的间隙会在当前布线的周围用灰色的轮廓表示。可以通过改变 "偏好设置" 对话框中的 "间隙轮廓" 设置来禁用间隙轮廓功能。

NOTE

间隙轮廓显示从布线网络到 PCB 上任何其他铜对象的最大间隙。可以使用自定义设计规则为不同对象指定网络的不同间隙。布线器将考虑这些间隙，但仅直观地显示最大间隙值。

当布线器处于活动状态时，将从布线起点到编辑器光标绘制新的线段。这些线段是未固定的临时 (*unfixed temporary*) 对象，它们显示当您左键鼠标或 **Enter** 键来确定布线 (*fix the route*) 时将创建哪些线段。非固定布线段以比固定布线段更亮的颜色显示。当您使用 **Esc** 键或通过选择另一个工具退出布线器时，将只保存固定布线段。完成布线操作(快捷键 **End**) 将固定所有布线并退出布线器。

在布线时，可以使用 "撤消上一个布线段" 命令 (快捷键 **Backspace**) 取消上一个固定的布线。您可以重复使用此命令后退已固定的布线。

In previous versions of KiCad, using the left mouse button or **Enter** to fix the routed segments would fix all segments up to but *not including* the segment ending at the mouse cursor location. In KiCad 6 and later, this behavior is optional, and by default, all segments *including* the one ending at the mouse cursor location will be fixed. The old behavior can be restored by disabling the "Fix all segments on click" option in the Interactive Router Settings dialog.

布线时，可以按住 **Ctrl** 键禁用网格捕捉，按住 **Shift** 键禁用对焊盘和过孔等对象的捕捉。

NOTE

也可以通过更改偏好设置对话框的编辑选项部分中的磁吸点首选项来禁用对象的捕捉。我们建议您在一般情况下保持启用对象捕捉，这样就不会意外地在焊盘或过孔上略微偏离中心结束布线。

交互式布线设置

The interactive router settings can be accessed through the **Route** menu, or by right-clicking on the  button in the toolbar. These settings control the router behavior when routing tracks as well as when dragging existing tracks.



Setting	Description
Mode	Sets the operating mode of the router for creating new tracks and dragging existing tracks. See the routing overview for more information.
Free angle mode	Allows routing tracks at any angle, instead of just at 45-degree increments. This option is only available if the router mode is set to Highlight collisions.
Allow DRC violations	Allow placing tracks and vias that violate DRC rules. This option is only available if the router mode is set to Highlight collisions.
Shove vias	Allow the router to shove vias along with tracks. When this is disabled, vias cannot be shoved. This option is only available if the router mode is set to Shove.
Jump over obstacles	Allow the router to attempt to move colliding tracks behind solid obstacles (such as pads). This option is only available if the router mode is set to Shove.
Remove redundant tracks	Automatically removes loops created in the currently-routed track, keeping only the most recently routed section of the loop.
Optimize pad connections	When this setting is enabled, the router attempts to avoid acute angles and other undesirable routing when exiting pads and vias.
Smooth dragged segments	When dragging tracks, attempts to combine track segments together to minimize direction changes.
Optimize entire track being dragged	When enabled, dragging a track segment will result in KiCad optimizing the rest of the track that is visible on the screen. The optimization process removes unnecessary corners, avoids acute angles, and generally tries to find the shortest path for the track. When disabled, no optimizations are performed to the track outside of the immediate section being dragged.
Use mouse path to set track posture	Attempts to pick the track posture based on the mouse path from the routing start location.
Fix all segments on click	When enabled, clicking while routing will fix the position of all the track segments that have been routed, including the segment that ends at the mouse cursor. A new segment will be started from the mouse cursor location. When disabled, the last segment (the one that ends at the mouse cursor) will not be fixed in place and can be adjusted by further mouse movement.

布线形态

在水平(H) / 垂直(V) / 45度模式下布线时，形态是指一组两个线段如何连接单个 H/V/45度线段无法到达的两个点。在这种情况下，这些点将由一条水平或垂直线段和一条斜线段(45度)连接。形态指的是这些线段的顺序：是水平/垂直线段在前还是斜线段在前。

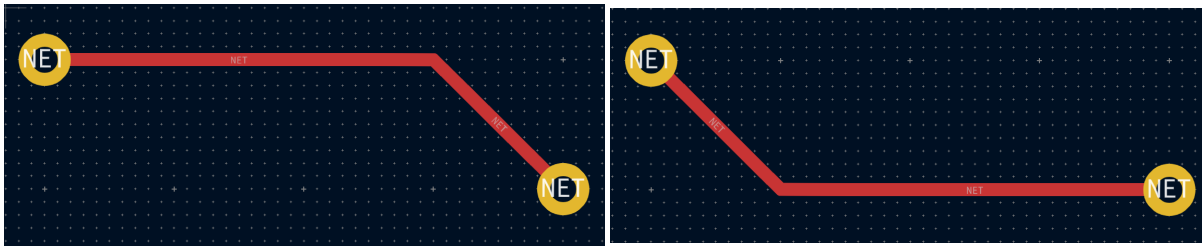

KiCad 的布线器会尝试根据一系列因素自动选择最佳形态。一般说来，布线器会尝试最大限度地减少路线中的拐角数量，并尽可能避免“糟糕”的拐角（如锐角）。当从焊盘布线或布线到焊盘时，KiCad 将选择使路线与焊盘最长边缘对齐的形态。

在某些情况下，KiCad 无法正确猜测您想要的形态。要在布线时切换布线的形态，请使用切换布线形态命令（快捷键 **/**）。

In situations where there is no obvious "best" posture (for example, when starting a route from a via), KiCad will use the movement of your mouse cursor to select the posture. If you would like the route to begin with a straight (horizontal or vertical) segment, move the mouse away from the starting location in a mostly horizontal or vertical direction. If you would like the route to begin diagonally, move in a diagonal direction. Once the cursor is a sufficient distance away from the routing start location, the posture is set and will no longer change unless the cursor is brought back to the starting location. Detection of posture from the movement of the mouse cursor can be disabled in the Interactive Router Settings dialog as described below.

NOTE

如果使用切换布线形态(Switch Track Posture)命令覆盖 KiCad 选择的形态，则在当前布线操作的剩余部分中，将禁用鼠标移动姿势的自动检测。

布线转角模式

当以 H/V/45 模式布线时，KiCad 的布线器可以放置尖角或圆角（弧形）的布线。要在尖角和圆角之间切换，请使用布线拐角模式命令（快捷键 **Ctrl** + **/**）。使用圆角布线时，每个布线步骤将放置直线段、单个圆弧或同时放置直线段和圆弧。布线形态决定首先放置圆弧还是直线段。

Track corners can also be rounded after routing by using the Fillet Tracks command after selecting the tracks on either side of the corner to be filleted. If a contiguous track selection contains multiple corners, they will all be filleted.

NOTE

Dragging of tracks with arcs is not supported. Arcs are treated as immovable by the shove router.

布线宽度

The width of the track being routed is determined in one of three ways: if the routing start point is the end of an existing track and the **[=]** button on the top toolbar is enabled, the width will be set to the width of the existing track. Otherwise, if the track width dropdown in the top toolbar is set to "use netclass width", the width will be taken from the netclass of the net being routed (or from any custom design rules that specify a different width for the net, such as inside a neckdown area). Finally, if the track width dropdown is set to one of the [pre-defined track sizes](#) configured in the Board Setup dialog, this width will be used.

NOTE

布线宽度永远不能小于在电路板设置对话框的约束部分中配置的最小布线宽度。如果添加的预定义宽度低于此最小约束，则将使用最小约束值。

KiCad 的布线器支持活动布线过程中的布线宽度调整。换句话说，要改变导线中间的宽度，必须结束布线，然后从上一个布线的末端重新开始一条新的布线。要改变活动布线的宽度，可使用快捷键 **W** 和 **Shift + W**，切换在电路板设置对话框中配置的布线宽度。

放置过孔

在进行布线时，切换层会在当前（未固定）导线的末端插入一个过孔。一旦你放置了过孔，布线将继续在新层上进行。有几种方法可以选择一个新层并插入过孔：

- 使用快捷键选择特定的图层，如 **PgUp** 选择 F.Cu 或 **PgDn** 选择 B.Cu。
- By using the Next Layer or Previous Layer hotkeys (**+** and **-**).
- By using the Place Via hotkey (**V**), which will switch to the next layer in the active layer pair.
- 通过使用 "选择图层并放置通孔过孔" 操作(快捷键 **<**)，将打开一个对话框来选择目标层。

After using any of the above methods to add a via and change layer, but before clicking to fix the via and commit the current track segment, you can cancel placing the via by pressing **V**. The via will be removed and routing will continue on the original layer.

You can place a via and end the current track, without changing layers, by pressing **V** and then double-clicking to place the via.

过孔的尺寸将取自当前的“过孔尺寸”设置中，可通过顶部工具栏的下拉列表或使用快捷键 (**↑**) “增加过孔尺寸”及快捷键 (**↓**) “减小过孔尺寸”。与布线宽度类似，当过孔大小设置为“使用网络类尺寸”时，将使用“电路板设置”的“网络类”部分中配置的过孔大小(除非被自定义设计规则覆盖)。

You can also place microvias and blind/buried vias while routing. Use the hotkey **Ctrl + V** to place a microvia and **Alt + Shift + V** to place a blind/buried via. Microvias may only be placed such that they connect one of the outer copper layers to an adjacent layer. Blind/buried vias may be placed on any layer.

布线器放置的过孔被认为是已布线导线的一部分。这意味着过孔网络可以自动更新（就像导线网络一样），例如，当从原理图中更新 PCB 时改变了导线的网络名。在某些情况下，这可能是不需要的，例如在创建缝合孔时。对于特定的过孔，可以通过关闭过孔属性对话框中的“自动更新过孔网络”复选框来禁用过孔网络的自动更新。使用“添加独立过孔”工具放置的过孔在创建时禁用这一设置。

Layer Pairs

The active layer is swapped with the other one in the current layer pair using the Place Via hotkey (**V**).

You can define the active pair along with a list of "preset" layer pairs in the Set Layer Pair dialog, accessed from the two-color swatch on the toolbar. These pairs are stored in the project file.

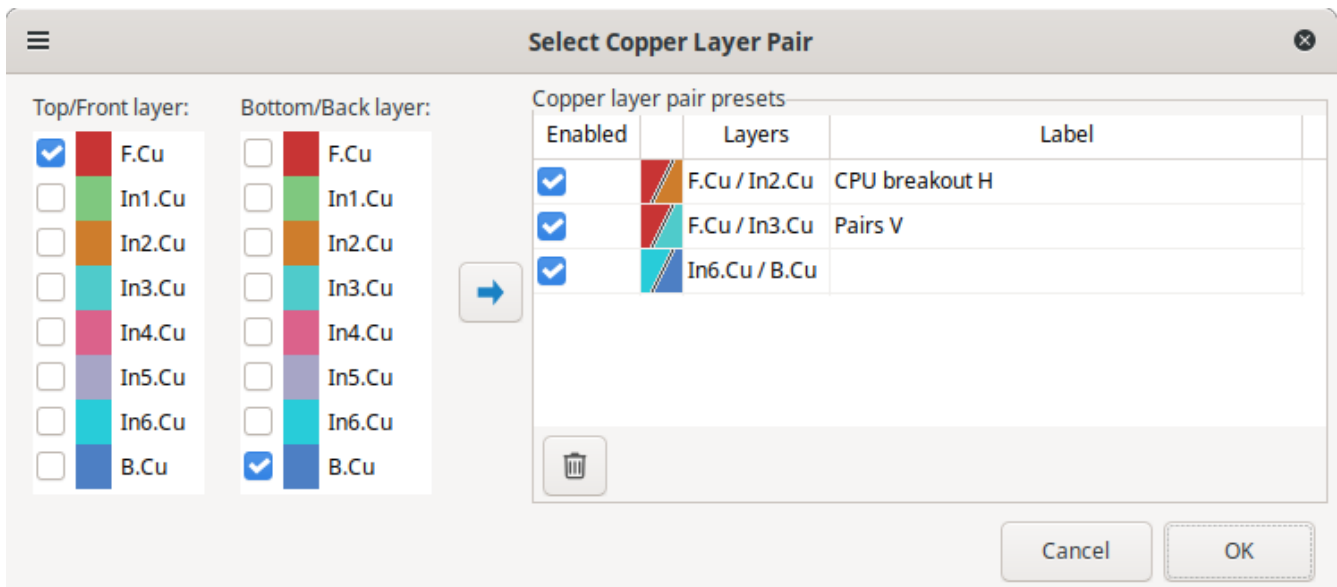

Each can be enabled or disabled, and given an optional user-friendly name.

The enabled presets can be cycled using the Cycle Layer Pair Presets hotkey (**Shift** + **V**). If the last-used or current layer pair is not a preset, it is included in the list with the name "Manual".

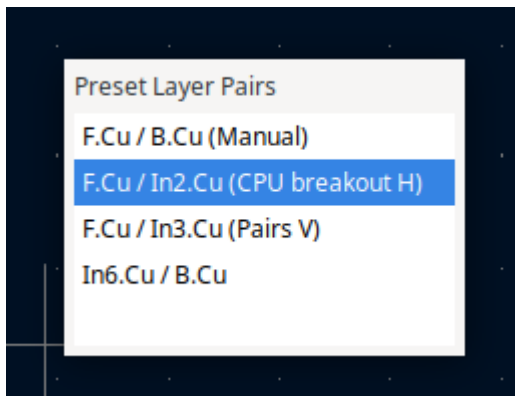

Placing free vias

In addition to [placing vias while routing](#), you can also place standalone vias. These vias connect to items that they touch when they are placed. Free vias may be useful for via stitching, via shielding, thermal design, or other reasons.

To place a free via, click the  button or press **Ctrl** + **Shift** + **X**, then click in the desired location in the editing canvas. If you place a via directly over a track, it will connect to that track as if it was placed while routing: it will take the track's net, it will create a joint in the track, and dragging the via will also drag the attached tracks.

The net assigned to a free via depends on where the via was placed. If the via was placed over a track or pad, it will have the same net as the track, and its **Automatically update via nets** setting will be enabled so that its net changes with the track's net. Otherwise, the via will take the net of any zone under the via, if one exists, and its net will not update automatically. If there are multiple zones under the via, you will be prompted to choose which net to use. If there is no zone, the via will not have a net assigned.

修改布线

布线完成后，可以通过移动或拖动来修改它们，或者删除并重新布线。当选择一个导线时，快捷键 **U** 可以用来将选择范围扩大到所有连接的导线。第一次按下 **U** 将选择与焊盘或过孔最近的连接点之间的导线。第二次按 **U** 将再次扩大选择范围，包括所有层上与所选导线相连的所有导线。用这种技术选择导线可以用来快速删除整个布线网络。

There are two different drag commands that can be used to reposition a track segment. The Drag (45-degree mode) command, hotkey **D**, is used to drag tracks using the router. If the router mode is set to Shove, dragging with this command will shove nearby tracks. If the router mode is set to Walk Around, dragging with this command will walk around or stop at obstacles. Multiple traces can be dragged at once using this command. The Drag Free Angle command, hotkey **G**, is used to split a track segment into two and drag the new corner to any location. Drag Free Angle behaves like the Highlight Collisions router mode: obstacles will not be avoided or shoved, only highlighted.

NOTE

目前还不能拖动包含圆弧的布线。在某些情况下，尝试拖动这些布线会导致圆弧被删除。可以通过选中特定圆弧并使用拖动命令 (**D**) 来调整其大小。使用此命令调整圆弧大小时，不执行 DRC 检查。

移动命令 (快捷键 **M**) 也可以在导线上使用。该命令将拾取选定的导线，而忽略任何未被选中的附加导线或过孔。使用移动命令移动导线时，不会进行 DRC 检查。

It is also possible to move a footprint while keeping tracks attached to the footprint as it moves. To do so, use the drag command (**D**) with one or more footprints selected. Any tracks that end at one of the footprint's pads will be dragged along with the footprints. This feature has some limitations: it only operates in Highlight Collisions mode, so the tracks attached to footprints will not walk around obstacles or shove nearby tracks out of the way. Any DRC violations caused by the drag operation will be highlighted and will prevent the footprint drag from being committed when you click. To ignore the violations and commit the drag anyway, use **Ctrl**+click. Additionally, only tracks that end at the origin of the footprint's pads will be dragged. Tracks that simply pass through the pad or that end on the pad at a location other than the origin will not be dragged.

To break a single track segment into two, use the Break tool (right click a track → **Break Track**). The track will be broken into two connected track segments at the cursor location. Each track segment can then be selected, moved, and edited individually. To recombine the segments into a single segment, drag the track, or use the **merge co-linear tracks** option in the [Cleanup Tracks and Vias dialog](#).

Editing track and via properties

You can modify the width of tracks and the size of vias, without re-routing them, in the properties dialog for the track or via. This modifies all selected tracks and vias. The properties dialog shows the relevant properties for the items in the selection: if both tracks and vias are selected, then properties for both types of objects will be displayed, but if only one type of object is selected then properties for the other type of object will not be shown.

Track & Via Properties

Common

Net: GND Automatically update via nets

Locked

Tracks

Start X: -- mixed values -- Y: -- mixed values -- mm Layer: -- mixed values --

End X: -- mixed values -- Y: -- mixed values -- mm

Technical Layers: Solder mask Expansion: -- mixed values -- mm

Pre-defined sizes: -- mixed values -- mm

Track width: -- mixed values -- mm

Vias

Position X: 189.15634 Y: 116.5098 mm Via type: Through

Pre-defined sizes: -- mixed values -- mm Start layer: Top_layer

End layer: Bottom_layer

Padstack mode: Normal Edit layer: All layers

Annular rings: All copper layers

Via diameter: 0.8 mm Front tenting: From design rules

Via hole: 0.4 mm Back tenting: From design rules

Add teardrops on via's track connections

Allow teardrops to span two track segments

Maximum track width: 90 %
(as a percentage of pad/via/track size)

Best length (L): 50 %(*d*)

Maximum length (L): 1 mm

Best width (W): 100 %(*d*)

Maximum width (W): 2 mm

Curved edges

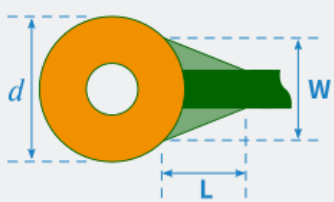

Cancel OK

In the Common section, you can change the assigned net of the selected objects using the **Net** dropdown. If the **Automatically update via nets** option is checked, the selected vias cannot have their assigned net manually changed, but instead will be assigned the net of any zone or pad that they touch. You can also [lock](#) the selected objects.

In the Tracks section, you can set the start and end position of the tracks and the layer they are on. You can also change the track width, either from a list of [pre-defined sizes](#) or to an arbitrary value.

You can remove the solder mask from on top of tracks on outer layers by enabling the **Solder mask** checkbox. When enabled, solder mask openings will be drawn for each of the selected tracks with the same shape as the source track. The **Expansion** textbox controls the size of the mask opening relative to the original track: the expansion value will be added to each side of the original track to form the mask shape. For example, a 1mm wide track with a 1mm expansion would result in a 3mm wide mask cutout, because the 1mm expansion is added to both sides of the track.

In the Vias section you can change the properties of selected vias. You can change the position of a via, the via's type (through, micro, or blind/buried), and which layers it spans. Through vias always start and end on the front and back copper layers, but micro vias and blind/buried vias can start and end on any layers.

You can modify the via annulus and hole diameters, either from a list of [pre-defined sizes](#) or to arbitrary values. A via's diameter and hole size can be defined on a per-layer basis. This is also known as defining the via's *padstack*. The **Padstack mode** controls whether the via shape is the same on all layers or whether individual layers are individually controlled.

- In the **Normal** padstack mode, the via's diameter and hole size are the same on all layers.
- In the **Front/Inner/Back** padstack mode, the via's diameter and hole size can be controlled separately for the front layer, the back layer, and the inner layers (the inner layers will have identical settings). The **Edit layer** dropdown controls which layer (or group of layers) is currently being displayed and edited.
- In the **Custom** padstack mode, the via's diameter and hole size can be controlled completely independently on each layer. The **Edit layer** dropdown controls which layer is currently being displayed and edited.

The **Annular rings** setting controls which layers will have annular rings for the via.

- When set to **All copper layers**, the via will have annular rings on every layer.
- When set to **Start, end, and connected layers**, the via will have annular rings on its start and end layers as well as any layer with a track or zone connection to the via. Any layer without track or zone connections, other than the start and end layers, will not have an annular ring.
- When set to **Connected layers only**, the via will have annular rings only on layers with a track or zone connection to the via. Any layer without track or zone connections will not have an annular ring.

Annular rings can be removed or added in bulk using the [Edit Track and Via Properties dialog](#) or by running the [Unused Pads tool](#).

The **Front tenting** and **Back Tenting** options control whether the via has front and back solder mask covering it.

- When set to **From design rules**, the tenting settings are taken from the Solder Mask/Paste panel in [Board Setup](#).
- When set to **Tented**, the via will be covered in solder mask, regardless of the settings in Board Setup.
- When set to **Not tented**, the via will not be covered with solder mask, regardless of the settings in Board Setup.

If the  button is pressed, the front and rear tenting settings will be linked. If it is unpressed, they can be modified independently.

You can also change the [teardrop properties](#) for vias in this dialog.

NOTE

The properties of selected tracks and vias can also be modified using the [Properties Manager](#).

Bulk editing tracks and vias

To modify tracks and vias in bulk you can use the Edit Track and Via Properties dialog (**Edit** → **Edit Track & Via Properties...**)..

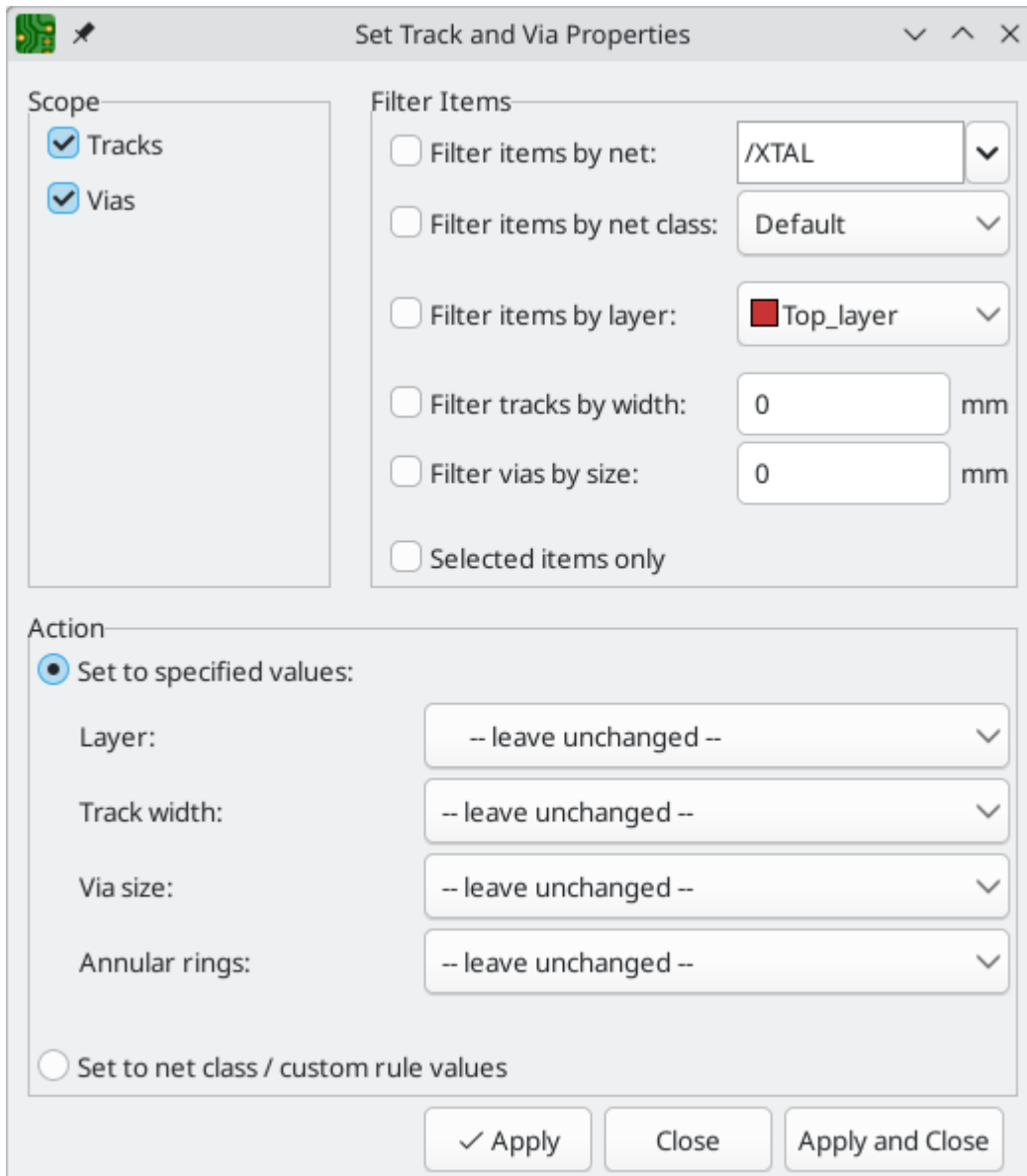

Scope settings restrict the tool to editing only tracks, vias, or both. If no scopes are selected, nothing will be edited.

Filter Items restricts the tool to editing particular objects in the selected scope. Objects will only be modified if they match all enabled and relevant filters (some filters do not apply to certain types of objects. For example, via size filters do not apply to tracks). If no filters are enabled, all objects in the selected scope will be modified. For filters with a text box, wildcards are supported: ***** matches any characters, and **?** matches any single character.

- **Filter items by net** filters to items assigned the specified net.
- **Filter items by netclass** filters to items assigned to the specified netclass.
- **Filter items by layer** filters to items on the specified board layer.
- **Filter tracks by width** filters to tracks with the specified track width.

- **Filter vias by size** filters to vias with the specified track width.
- **Selected items only** filters to the current selection.

Properties for filtered objects can be set to new values in the bottom part of the dialog. Properties can be set to arbitrary values by selecting **set to specified values** or set to the default value from the net class (or custom rule) by selecting **set to net class / custom rule values**.

When setting to specified values, you can choose `-- leave unchanged --` to preserve objects' existing values, or select a new value from the dropdown menu. For **Track width** and **Via size**, the options are the [pre-defined track or via sizes](#) from Board Setup.

Removing unused pads

You can quickly remove unused annular rings from pads and vias using the Unused Pads tool (**Tools** → **Remove Unused Pads...**). This will leave annular rings in place on layers where they are used and remove them on layers where they are not used. An annular ring is considered unused if there are no track or zone connections to the pad/via on that layer.

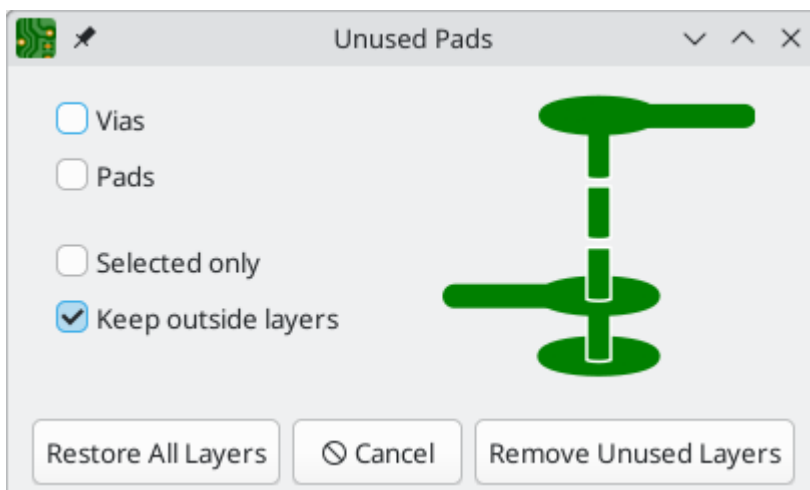

The **Remove Unused Layers** button removes all unused annular rings from pads and vias that meet the selected filter settings. The **Restore All Layers** button restores all annular rings to the pads and vias that meet the selected filter settings.

The checkboxes filter which objects will be modified (annular rings removed or restored) and which layers will be removed for those objects.

- If the **Vias** checkbox is enabled, annular rings for vias will be modified.
- If the **Pads** checkbox is enabled, annular rings for pads will be modified.
- If the **Selected only** checkbox is enabled, only selected vias and pads will have their annular rings modified. If it is disabled, annular rings for all vias and pads will be modified. This setting applies in combination with the **Vias** and **Pads** checkboxes; for example, a selected via will not be modified if the **Via** checkbox is disabled.
- If the **Keep outside layers** checkbox is enabled, the pad or via's start and end layers will remain, even if they are unused.

Cleaning up tracks and vias

There is a dedicated tool for performing common cleanup operations on tracks and vias, which is run via **Tools → Cleanup Tracks & Vias...**

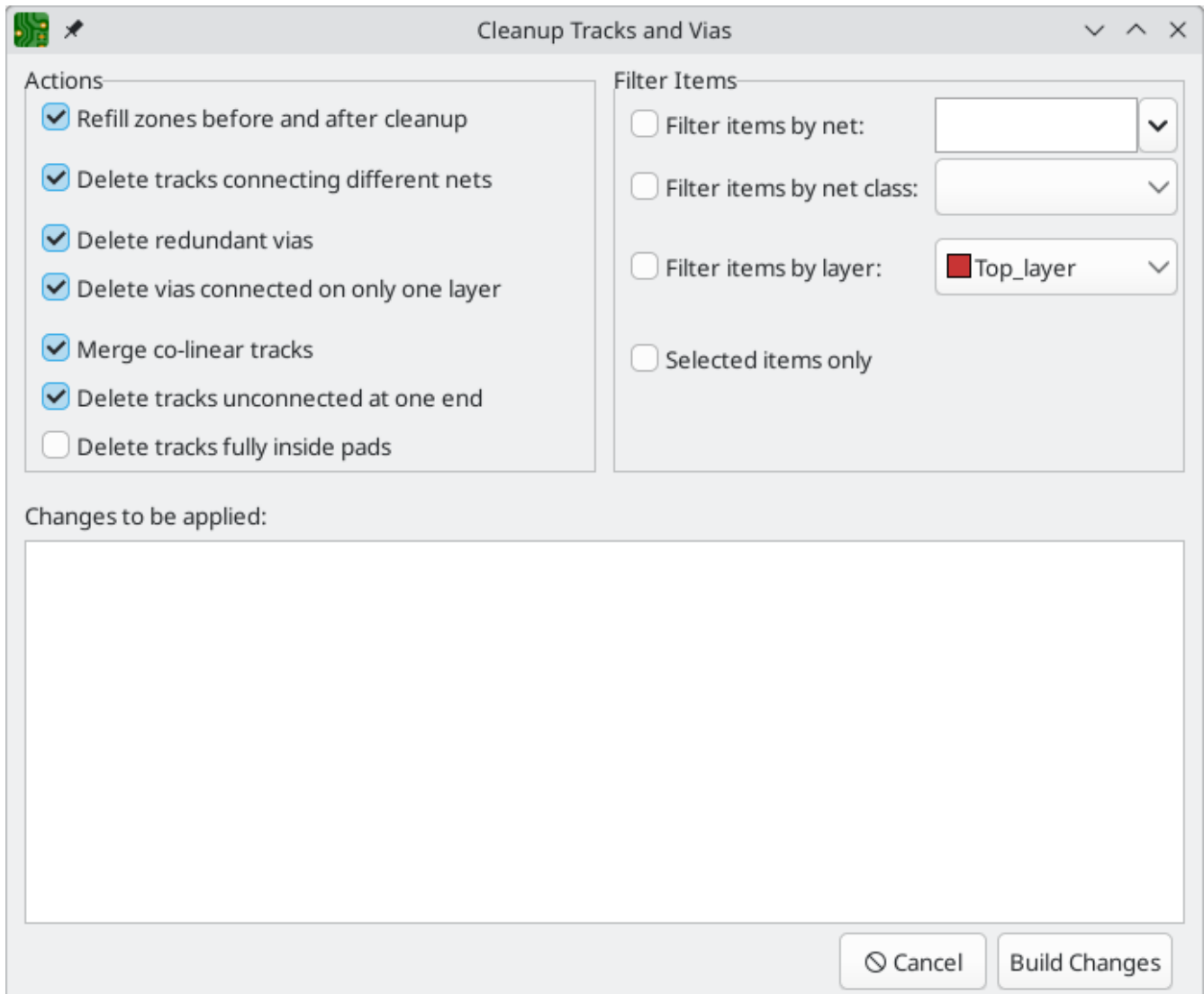

The following cleanup actions are available and will be performed when selected:

- **Refill zones before and after cleanup:** refills all zones both before and after the cleanup operation. If unchecked, zone fills will not be changed.
- **Delete tracks connecting different nets:** removes any track segments that short multiple nets.
- **Delete redundant vias:** remove vias that are redundant because they are located on top of another via or on top of a through hole pad.
- **Delete vias connected on only one layer:** removes vias that are only connected to copper on a single layer and are therefore unnecessary.
- **Merge co-linear tracks:** merges any track segments that are connected and co-linear into a single equivalent track segment.
- **Delete tracks unconnected at one end:** removes track segments that have at least one dangling end.
-

Delete tracks fully inside pads: removes tracks that have both start and end points within a pad and are therefore unnecessary.

You can also filter the objects that will be cleaned up by net, netclass, layer, or selection.

- **Filter items by net:** limits the cleanup to tracks and vias assigned to the specified net.
- **Filter items by netclass:** limits the cleanup to tracks and vias in the specified netclass.
- **Filter items by layer:** limits the cleanup to tracks and vias on the specified layer.
- **Selected items only:** limits the cleanup to just the selected tracks and vias.

Any changes that will be applied to the board are displayed at the bottom of the dialog after clicking the **Build Changes** button. After building the changes, the button changes to say **Update PCB**. The changes are not applied until you press the **Update PCB** button.

Routing Convenience Functions

KiCad offers several functions to make certain routing operations more convenient.

If you need to route a number of tracks from a set of pads, you can use the Route Selected tool to quickly route from each pad in sequence. Select the pads you want to use as starting points, then right click and choose **Route Selected** (**Shift** + **X**) to route from each pad in sequence. The router will begin a track from the first selected pad, which you can route as you would any other track. When you complete the track, the router will automatically begin a new track from the next pad in the selection, in the same order that you selected the pads. Pads that already have tracks attached are skipped. You can also skip routing the current track and move on to the next pad by pressing **Esc**. You can also select footprints instead of pads; all unrouted pads in the selected footprints will be used as starting points.

If you want to route a number of tracks *to* a set of pads, instead of *from* the pads, you can use the Route Selected From Other End tool. Select the pads you want to use as ending points, then right click and choose **Route Selected From Other End** (**Shift** + **E**). This tool works the same way as the Route Selected tool, except it uses each selected pad as an end point rather than a starting point. The starting point for each track is the other end of the ratsnest line for each selected pad.

Routing from the other end is also possible while routing individual tracks: press **Ctrl** + **E** while routing a track to commit the current segment and begin routing from the other end of the in-progress track's ratsnest line.



Finally, you can quickly unroute tracks connected to an object (footprint, pad, or track) by selecting the object, right-clicking, and choosing **Unroute Selected**. Any tracks connected to the selected object will be removed, starting at the selected object and continuing until another pad is encountered.

Automatically completing tracks

KiCad's router can automatically route individual tracks, based on the connections defined in the schematic. This can be thought of as a limited form of auto-routing that considers a single track at a time. The router will only use the current layer; it will not use vias or change layers.



While routing, press the **F** key to have the router attempt to automatically finish the current track. The track will be automatically routed from the end of the last fixed track segment to the closest ratsnest

anchor. If the router can't automatically finish the track, it will allow you to complete the track manually. This action can also be performed by clicking **Attempt Finish** in the context menu while routing.

When the router is not the active tool, you can automatically route multiple tracks by selecting footprints, pads, and tracks to route from, right clicking, and choosing **Attempt Finish Selected (Autoroute)** ( + ). You do not need to select both ends of a desired connection; the router will route from the selected item to its nearest ratsnest anchor. If multiple items were selected, each item will be routed in sequence, in the order that they were selected. If a connection cannot be automatically completed, the tool will pause with the router active so that you can complete the track manually. With the automatic completion paused for a manual connection, you can press  to skip routing the current track. After manually completing the track or skipping the connection, the tool will continue attempting to route the remaining connections.

差分对布线

Differential pairs in KiCad are defined as nets with a common *base name* and a positive and negative suffix. KiCad supports using + and -, or P and N as the suffix. For example, the nets USB+ and USB- form a differential pair, as do the nets USB_P and USB_N. In the first example, the base name is USB, and USB_ in the second. The suffix styles cannot be mixed: the nets USB+ and USB_N do not form a differential pair. Make sure you name your differential pair nets accordingly in the schematic in order to allow use of the differential pair router in the PCB editor.







要对差分对进行布线，请点击差分对布线  图标（从绘图工具栏或从顶部工具栏 **布线** 下）或使用快捷键 。点击一个焊盘、过孔或现有差分对线段的末端，开始布线。你可以从差分对的正网络或负网络开始布线。

差分对布线器将尝试用设计规则中的间隙规则进行布线(差分对间隙可以在电路板设置对话框的“网络类”部分中配置，也可以通过使用自定义设计规则来配置)。如果布线的起始或结束位置与配置的间隙不同，布线器将创建一个较短的“扇出”部分，以最大限度地缩短差分对未耦合的布线长度。

当切换层或使用放置过孔 () 操作时，差分对布线器将创建两个相邻的过孔。这些过孔将被放置在尽可能靠近彼此的位置，同时遵守铜的间隙规则以及孔到孔的间隙规则。

长度调整

The length tuning tools can be used to add serpentine tuning shapes to tracks after routing. Length tuning shapes are persistent objects that can be modified after they are created. To tune the length of a track, first pick the appropriate tool.

- The single-track length tuning tool (icon  or hotkey ) will add serpentine shapes to bring the length of a single track up to the target value.
- The differential pair length tuning tool (icon  or hotkey ) will do the same for a differential pair.
- The differential pair skew tuning tool (icon  or hotkey ) will add length to the shorter member of a differential pair in order to eliminate skew (phase difference) between the positive and negative sides of the pair.

As with the Routing icons, the Tuning icons are found in both the **Route** menu dropdown from the top toolbar and the drawing toolbar on the right.

When a tuning tool is active, you can hover over tracks in the board to show a status window that displays their current length or skew as well as the target values. Click on the desired track to start tuning it. As you move the mouse cursor along the track, meander shapes will be added interactively. If a target length has

been set, meanders will stop being added when the target length is reached. You can set a target length with custom DRC rules or in the tuning shape properties; both methods are explained below. The popup window next to the cursor shows a live measure of the length or skew compared to the design targets. You can adjust the spacing (1 to increase and 2 to decrease) and amplitude (3 to increase and 4 to decrease) while you tune. When you are done, click again to commit the tuned shape. The tuned track doesn't need to be perfect because you can adjust the shape after committing it. You can also place multiple tuning shapes on the same track.

NOTE The length tuning tools only support tuning the length of point-to-point nets between two pads. Tuning the length of nets with different topologies is not supported.

NOTE Differential pair length tuning can only be applied to the coupled portions of differential pairs. To apply length tuning to the uncoupled portions of differential pairs, you must use single-track length tuner.

Editing tuning patterns

After a tuning pattern has been added, it can be selected, modified, and moved. While it is selected, the target length and routed length are shown in the message panel at the bottom left of the window.

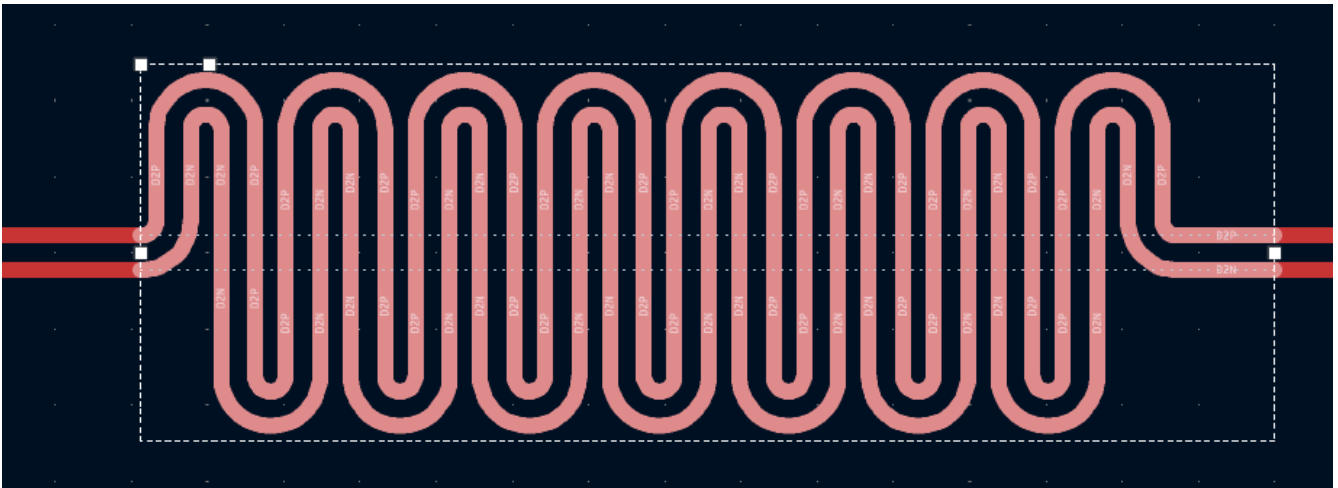

When a pattern is selected, editing handles appear, which let you adjust the pattern geometry.

- Dragging the handles at the ends of the pattern will expand or contract the pattern along the track.
- Dragging the corner handle towards or away from the track will respectively decrease or increase the maximum meander amplitude.
- The final handle controls the meander spacing; dragging it towards the corner handle will increase the spacing, while dragging it away from the corner handle will increase the spacing.

The selection box and editing handles represent the maximum allowable extents of the tuning pattern. Making the box smaller will reduce the size of the tuning pattern, even if this results in the tuned track being shorter than the target length. When the box is enlarged, the tuning pattern will expand to fill the box until the target length is reached.

You can move a tuning pattern along its track by selecting it and dragging with the mouse, or using the Move tool (M). Deleting a tuning pattern (Del) removes the tuning pattern and restores the original untuned tracks. You can also [ungroup](#) the tuning pattern, which will decompose it into its component tracks. The

basic tracks have the same shape as the tuning pattern but can be edited individually. Once ungrouped into tracks, a tuning pattern cannot be regrouped.

Another way to edit a tuning pattern is through its properties dialog. The properties dialog exposes several additional parameters that can't be modified using the on-canvas interactive editor. These properties can also be edited in the [Properties Manager](#).



As with the interactive editor, you can set a maximum amplitude for the tuning pattern and a spacing between meanders, but here you can set a minimum amplitude and configure the corner style. Corners can be **filleted** (rounded) or **chamfered**. In each case you can set the **radius** as a percentage of the maximum possible radius for the spacing and amplitude. You can also configure the tuning pattern to be **single-sided**, which restricts it to one side of the baseline, as opposed to the default style which positions meanders on both sides of the baseline.

You can set default values for these properties in the **Design Rules** → **Length-tuning Patterns** page of the Board Setup dialog. Each type of tuning pattern (single track length, differential pair length, and differential pair skew) can have its own defaults.

Finally, the tuning pattern properties dialog is one of two ways to set the target length or skew for a tuning pattern. Setting length targets is explained below.

Setting target length and skew

There are two ways to set a target length or skew for a net:

- In the properties dialog for a tuning pattern that has already been added to a track.
- Using a custom DRC rule with the `length` and/or `skew` constraints.

The first method is to specify a target in the **target length** or **target skew** field of the tuning pattern's properties dialog. This target will only apply to the selected tuning pattern. Therefore, length targets set in this way must be set separately for each tuning pattern in the design. The properties dialog for a tuning

pattern is only accessible after the pattern is initially created, so changing a target length or skew in this way may require the pattern to be adjusted to meet the new target value, if the pattern's geometric constraints do not allow sufficient space to meet the new target.

You can also set a target length and/or skew using [custom design rules](#). If custom rules are used, they will override any targets set in tuning pattern properties, unless the **override custom rules** checkbox is enabled in the tuning pattern properties.

Using a custom rule allows you to set a net's target length and/or skew up front, before a pattern is created. With custom rules you can set different length and skew targets based on specific criteria, such as netclass or net name. You will also result in a DRC violation if the net's length or skew is out of bounds.

When target length or skew is adjusted in a custom DRC rule after a pattern is created, the pattern geometry will not be automatically updated to achieve the new target. You can use **Edit** → **Update All Tuning Patterns** to recalculate all tuning patterns to meet the new targets.



The following example custom rule sets a target length and skew for nets in the `high_speed` netclass. The target length is 100mm, and a DRC error will be raised if it is below 95mm or above 105mm. The target skew is at most 0.1mm.

```
(rule "target length and skew"
  (condition "A.hasNetclass('high_speed')")
  (constraint length (min 95mm) (opt 100mm) (max 105mm))
  (constraint skew (max 0.1mm)))
```

See the custom rule documentation for more details of how to create rules that only apply to certain nets.

Length tuning pitfalls and tips

The length tuner only tunes nets with a point-to-point topology; branching nets are not supported. When the length tuner encounters a branch, it stops at the branch and only considers the length of the net up to that branch.

Sometimes you may end up with leftover stub tracks somewhere in your design. These can turn what appears to be a point-to-point net into a branched topology, which will prevent length tuning from working as expected. It may be easier to find such stub tracks when you switch footprints, vias, and tracks to outline mode (, , and  buttons, respectively). You can also use the [track cleanup tool](#) (**Tools** → **Cleanup Tracks and Vias...**) to remove many of these stubs automatically.

By default, the length tuner includes vias in its length calculations. Only the layer-to-layer length of the via is used, which may be shorter than the full top-to-bottom via height if the tuned path is not exclusively on the board top and bottom. The accuracy of this calculation depends on the board stackup being accurately configured. Via length can be ignored in length tuner calculations by deselecting **include stackup height in track length calculations** in the **Constraints** page of the [Board Setup dialog](#).

The length tuner is optimized for adjusting the effective electrical distance between two points, and therefore it calculates net length in a slightly different way than other tools, such as the Net Inspector. In addition to discounting net branches and unused portions of vias, the length tuner also optimizes paths through pads to use the shortest possible path in its calculations. In comparison, the Net Inspector reports a

simple summation of copper segment lengths. Both calculations are accurate, but they are optimized for different purposes. These differences are discussed in more detail in the [Net Inspector documentation](#).

Teardrops

Teardrops are areas of extra copper that smooth the transition between tracks and pads, vias, or other tracks with different width. Teardrops are added to increase the mechanical robustness of a track connection. They also reduce the risk of a misaligned drill hole disconnecting a track from a drilled pad or via.

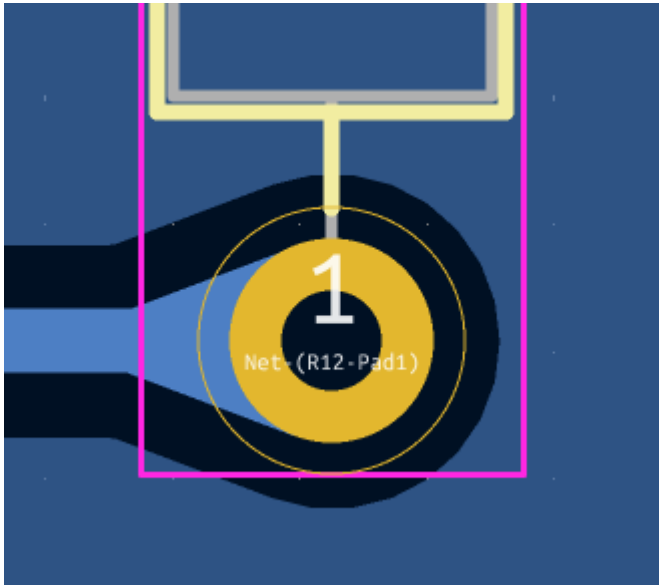

You can add teardrops to your design in bulk using the **Edit** → **Edit Teardrops...** dialog. This dialog has controls for filtering which objects are affected and settings for configuring the shape of the new teardrops. It also lets you edit or remove existing teardrops.

The **Scope** section controls which types of objects will be affected: PTH pads, SMD pads, vias, and/or track-to-track connections. The **Filter Items** section lets you filter objects by other criteria; you can filter items by net, net class, and layer, or choose to act only on round pads, pre-existing teardrops, or the objects in your selection.

The **Action** section controls whether to add or remove teardrops, as well as the size and shape of the new teardrops.

Remove Teardrops will remove teardrops that match the scope and filtering options at the top of the dialog. **Remove All Teardrops** will remove all teardrops on the board, even if they do not match the scope and filters.

Add teardrops with default values for shape will add teardrops with the configured default teardrop settings to every board object that matches the scope and filters. To configure the default teardrop settings, click the **Edit default values in Board Setup** link or manually open the **Teardrops** panel in [Board Setup](#). The defaults are configured separately for teardrops connecting to round shapes, rectangular shapes, or between tracks. Instead of using the default values, you can provide custom teardrop settings by selecting **Add teardrops with specified values**.

The available teardrop settings are:

-

Prefer zone connection: if selected, a teardrop will not be created if the object is also connected to a zone.

- **Allow teardrops to span 2 track segments:** if selected, the teardrop will be able to spread over a second track segment if the first segment is too short to support a full teardrop.
- **Maximum track width:** a teardrop will not be created for a track connection that is wider than this percentage of the pad width (minimum pad dimension).
- **Best length:** the ideal length of the teardrop, as a percentage of the width (smallest dimension) of the attached object.
- **Maximum length:** the maximum length of the teardrop, as an absolute length.
- **Best width:** the ideal width of the teardrop, as a percentage of the width (smallest dimension) of the attached object.
- **Maximum width:** the maximum width of the teardrop, as an absolute width.
- **Curved edges:** if selected, the teardrop edges will be curved instead of a straight line.

Adding a teardrop to an object that already has a teardrop will update the existing teardrop with the new settings. However, you can leave any existing teardrop setting in an object unchanged by setting the value to `-- leave unchanged --` in a textbox, or by selecting the third, indeterminate state for a checkbox. Any value set this way will not be updated in the targeted objects' teardrop settings.

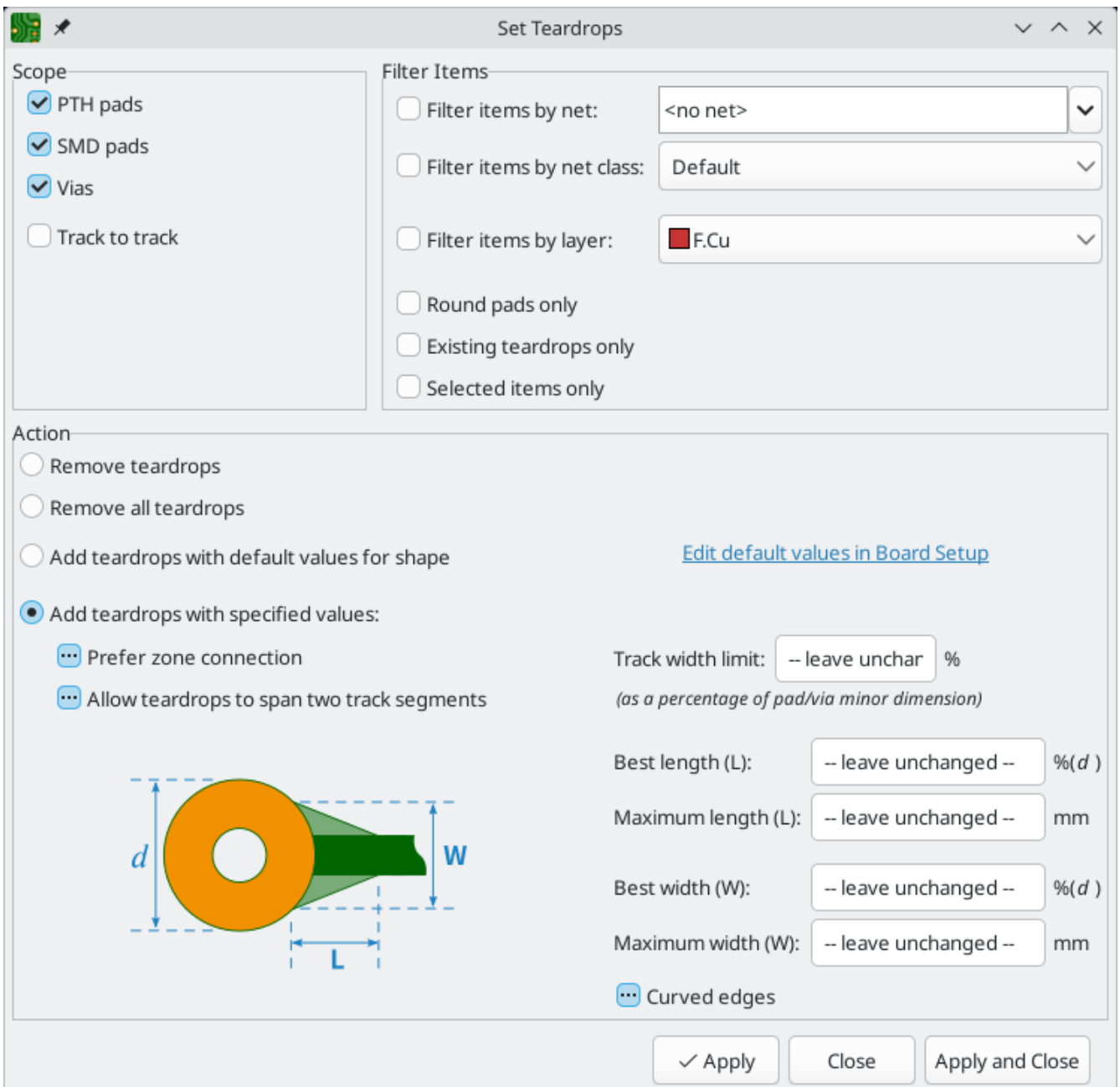

Rather than in bulk, you can add or edit teardrops for individual vias in the properties dialog for that via, or for individual pads in the **Connections** tab of the pad's properties dialog. The settings in the properties dialogs are the same as in the Edit Teardrops dialog. You can also edit teardrops for individual pads and vias with the [Properties Manager](#).

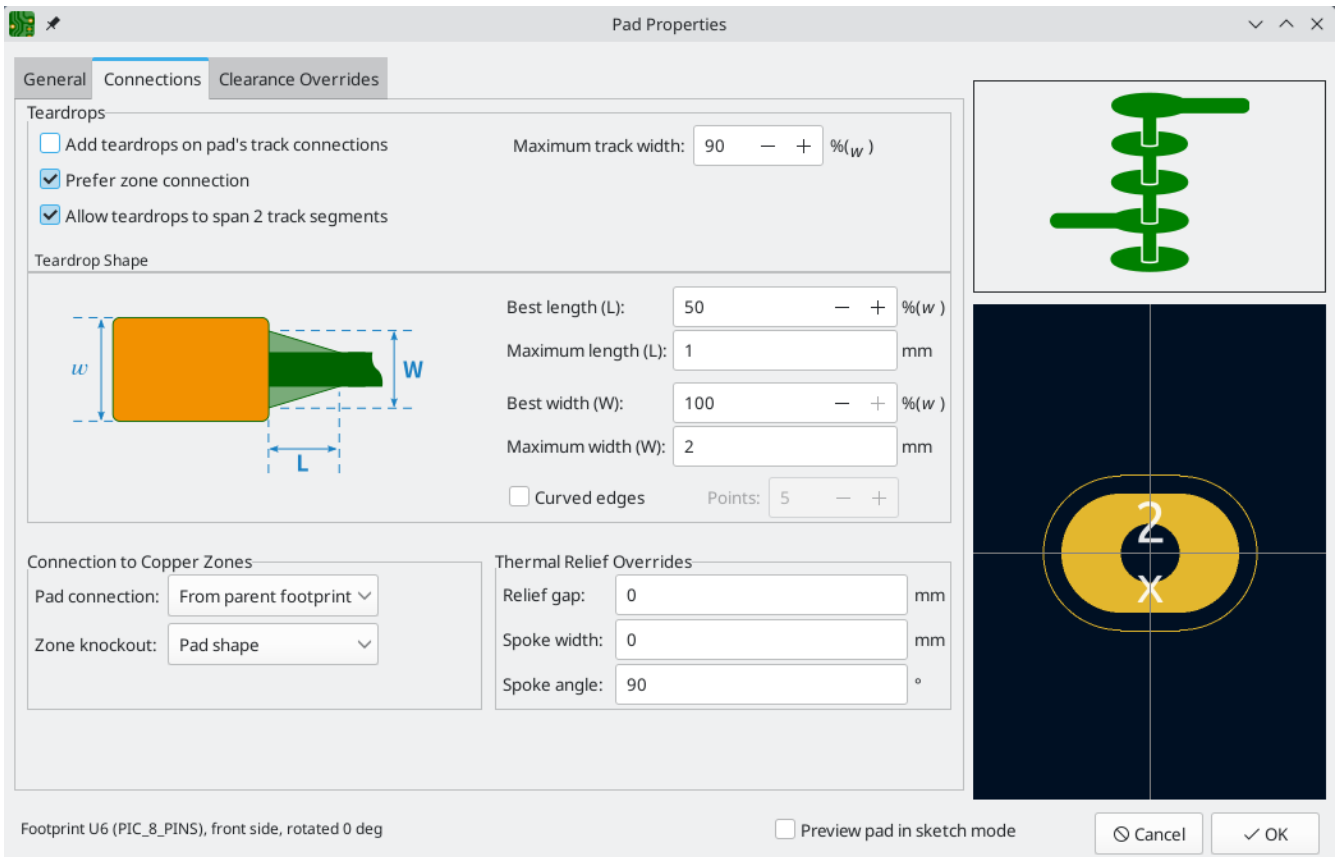

Teardrops in KiCad are small zones, meaning that when they refill they avoid shorting to copper objects on other nets. They are initially filled when they are added, but they are unfilled and refilled with other zones on the board: when using the Unfill All Zones and Refill All Zones commands, running DRC, generating fabrication outputs, etc. Teardrops can be shown in filled or outline mode using the zone display controls in the left toolbar.

NOTE

Teardrops can be added to any type of pad, including custom pads. Some custom pad shapes may produce undesirable teardrop shapes. In those cases, it may be preferable to disable teardrop generation for those specific pads.

Graphics and text

Graphical objects (lines, arcs, rectangles, circles, polygons, text, tables, and dimensions) can exist on any layer. They exist primarily for aesthetics and documentation, although shapes on copper layers can make electrical connections and have nets assigned.

Graphical shapes







Graphical shapes are geometric objects that can be drawn on any board layer.

When they are drawn on copper layers, graphical objects can be assigned nets and make connections to other copper objects, much like tracks and zones. There are differences between copper shapes and tracks or zones, however:

- The shape of a graphical object is exactly defined by its own properties (size, position, line width, fill, etc.) and is not affected by other nearby objects. In contrast, a zone fills the area within a specified outline, but avoids different-net copper items to automatically maintain a specified clearance.
-

Graphic lines and arcs are edited as simple shapes; the [interactive router](#) is not used for drawing or modifying them. Therefore collisions with other items are not detected interactively as they would be when routing tracks (although they will be detected by [DRC](#)).

The buttons on the right toolbar can be used to create:

- Lines ( , default hotkey Ctrl + Shift + L)
- Arcs ( , default hotkey Ctrl + Shift + A)
- Bezier curves ( , default hotkey Ctrl + Shift + B)
- Rectangles ()
- Circles ( , default hotkey Ctrl + Shift + C)
- Polygons ( , default hotkey Ctrl + Shift + P)

To place a shape, select the tool, then click in the canvas to place the shape's first point. Click again to place the shape's second point. For rectangles and circles, placing the second point will fully define the shape and finish drawing it. Some shapes require three or more points to be placed, however. Arcs require three points, while lines, polygons and bezier curves can accept an arbitrary number of points, and require a double click to complete.

To modify an existing graphical object, select it, then drag its editing handles to change the shape. Moving a handle at the vertex of a shape will move that vertex. Moving a handle on the edge of a shape will move that edge while maintaining the edge's angle.

Arcs have two vertex editing modes, which are selectable in **Preferences** → **PCB Editor** → **Editing Options** or by right clicking the  button on the right toolbar.

- The first mode (**keep arc center, adjust radius**) maintains the position of the arc center as the arc endpoints or midpoint are dragged, changing the radius as necessary.
- The second mode (**keep arc endpoints or direction of starting point**) maintains the position of the arc endpoints and the arc's direction of curvature as the midpoint or center are dragged.

Just like with tracks, you can expand a selection from one graphic line to include all other contiguous graphic lines by pressing U.

The properties of a graphic shape can be adjusted in the shape's properties dialog or with the [Properties Manager](#).

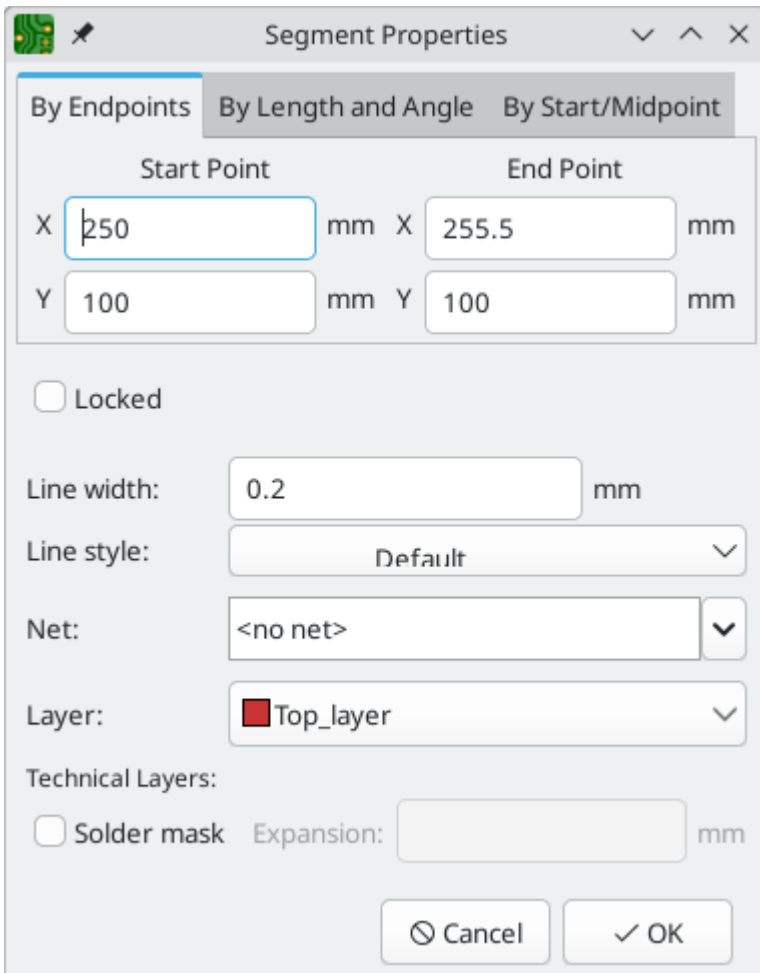

- The top section contains controls for editing the object's location and shape. Some types of objects can be edited in multiple ways, with each method in its own tab. For example, a line segment can be edited by its start and end points, by its start point, length, and angle, or by its start and mid points.
- **Locked** controls whether or not the text object is **locked**. Locked objects may not be manipulated or moved, and cannot be selected unless the **Locked Items** option is enabled in the Selection Filter panel.
- Closed shapes (rectangles, circles, and polygons) can be outlines or filled shapes, which is controlled by the **Filled shape** checkbox.
- The **Line width** option controls the width of the outline, even for filled objects. The outline width extends on both sides of the "ideal" shape of the graphic object. For example, a graphic circle that is defined to have 2mm radius and 0.2mm line width will consist of a torus with an outer radius of 2.1mm and inner radius of 1.9mm. If the shape is filled and the line width is set to 0, the shape will be a filled circle with 2mm radius. Several line styles are available in the **Line style** dropdown: solid, dashed, dotted, dash-dot, and dash-dot-dot.

NOTE

You can customize the default style of newly-created graphical shapes in the Text & Graphics Defaults section of the Board Setup dialog.

- The **Layer** dropdown controls which layer the shape is placed on. Graphical shapes on copper layers can have a net assigned in their properties dialog. Copper shapes with a net make connections like tracks or zones. Unlike zones, copper graphical objects always maintain their shape and do not keep clearance to other copper objects.

When shapes are placed on outer copper layers, they can be configured to affect the corresponding solder mask layer in addition to their primary copper layer by enabling the **Solder mask** checkbox. When enabled, a shape on the front copper layer will also be drawn on the front solder mask layer, while a back copper shape will also be drawn on the back solder mask layer. Because solder mask layers are negative, this will result in a solder mask opening with the same shape as the copper shape. The **Expansion** textbox controls the size of the mask opening relative to the original copper shape: the expansion value will be added to each side of the original shape to form the mask shape. For example, a 1mm wide copper segment with a 1mm expansion would result in a 3mm wide mask cutout, because the 1mm expansion is added to both sides of the segment.

Shape modification tools

KiCad has several tools for modifying combinations of graphic shapes in useful ways, such as chamfering two lines or combining two polygons. These tools are used by selecting the shapes you want to modify, right clicking, and then choosing the relevant tool in the **Shape Modification** submenu. Different tools are available for different combinations of selected shapes.

- **Heal shapes** fixes a discontinuity between two lines or arcs. A new line segment is added to connect the ends of each shape together, up to a specified tolerance.
- **Fillet lines** adds an arc to round the corner between two connected lines with a specified radius. The two original lines are shortened to meet the endpoints of the arc.
- **Chamfer lines** adds a line segment to create a new edge between two connected lines with a specified setback. The two original lines are shortened to meet the endpoints of the new segment.
- **Dogbone corners** adds circular reliefs to the corners of the selected shapes. This is similar to filleting, but the modified shape is larger than the original, with the added arcs intersecting the vertices of the original corners. In other words, the added reliefs exactly enclose the original corners. This can be useful for relieving the corners of interior cutouts so that they can be manufactured using a round cutting tool. There is an option to **Add slots to acute corners**, which adds extended slots in corners that are too narrow to reach with a cutting tool of the selected radius.
- **Extend lines to meet** lengthens two selected lines until they intersect each other. The two lines will share a coincident endpoint.
- **Merge polygons** combines two or more selected polygons into one new polygon that is the union of the original shapes.
- **Subtract polygons** subtracts one or more polygons from another polygon, resulting in a new polygon that is the difference of the original shapes. The first-selected polygon(s) are subtracted from the last-selected polygon.
- **Intersect polygons** results in a new polygon that is the shape of the overlapping area between two or more selected polygons.

Converting objects to and from graphic shapes

KiCad provides tools to convert graphic objects to other types of objects, other types of objects to graphic objects, and graphic objects to other kinds of graphic objects. These tools are used by selecting the shapes you want to convert, right clicking, and then choosing the desired result object from the **Create From Selection** submenu. Most types of object conversions have several conversion options that are presented in a settings dialog. The exact options differ based on the target object type.

When converting to a graphic polygon, rule area, or zone, there are several options for how to convert the source objects into a polygonal outline.

- If **copy line width of first object** is selected, an unfilled polygon will be created that has its line width taken from the line width of the first selected source object. This option is only available when converting to a graphic polygon, and the source object must be a closed shape.
- If **use centerlines** is selected, an object with zero line width will be created, with its outline placed at the centerlines of the source objects. The source object must be a closed shape. If the target object is a graphic polygon, it will be filled.
- If **create bounding hull** is selected, an object will be created with the specified **line width**. The object's outline will be offset from the outermost extents of the source object by the specified **gap**. The source object does not need to be a closed shape when a bounding hull is created.

Most conversions provide a **delete source objects after conversion** option, which will result in the original object being deleted during the conversion, only leaving the new object in place. If this option is not selected, the conversion will leave the original object in place in addition to the new object. The original object will be selected following the conversion so that it can be manually deleted by pressing Delete.

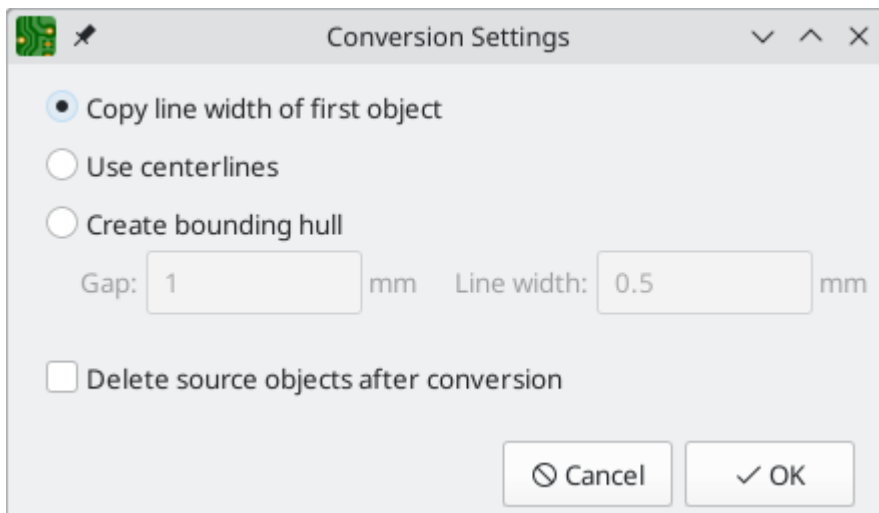

The following conversion types are available:

- **Create Polygon From Selection** converts a graphic shape, text, zone, rule area, or track into a polygon. This can be used to convert separate graphic shapes, such as lines and arcs, into a unified shape. It can also be used to convert a text object into a shape that can have its outline manipulated graphically.
- **Create Zone From Selection** converts a graphic shape, text, zone, rule area, or track into a zone. In addition to the conversion settings, the conversion dialog also shows options for [configuring the resulting zone](#). This can be used to create zone outlines with complex shapes, such as curves, that would otherwise be difficult to create using the zone tool.
- **Create Rule Area From Selection** converts a graphic shape, text, zone, rule area, or track into a rule area. In addition to the conversion settings, the conversion dialog also shows options for [configuring the resulting rule area](#). This can be used to create rule area outlines with complex shapes, such as curves, that would otherwise be difficult to create using the rule area tool.
- **Create Lines From Selection** converts a graphic polygon or rectangle into graphic lines that follow the source shape's outline. This can be used to convert a unified shape into its constituent outline segments.

Create Outsets From Selection converts the selected object (graphic shapes, pads, etc.) into a rectangle that surrounds the original shape with some spacing. This can be used to quickly create outlines, courtyards, etc., especially in combination with other shape modification tools.

- The **Outset** distance specifies the minimum distance between the outset and the original shape. There will always be at least this much space between the two shapes.
 - If **Round corners (when possible)** is enabled, the outset will have rounded corners rather than being a simple rectangle.
 - If **Round outwards to grid multiples (when possible)** is enabled, the outset will be placed on the specified grid, rounding outwards when necessary so that the specified outset distance is maintained.
 - If **Copy item layers** is enabled, the outset will be drawn on the same layer as the original shape. If disabled, the outset will be drawn on the layer selected in the dropdown menu.
 - If **Copy item thickness (when possible)** is enabled, the outset will be drawn with the original item's thickness if that item has a thickness, or the specified thickness otherwise. Some source items, like pads, do not have a thickness property. The specified thickness will always be used when this option is disabled.
- **Create Tracks From Selection** converts a graphic shape, zone, or rule area into tracks that follow the source shape's outline. If the source object is not on a copper layer, a dialog will be presented to specify the target copper layer. The source object is not removed following conversion, but remains selected so that it can be easily deleted if desired.
 - **Create Arc From Selection** converts a graphic line segment or track segment into a graphic arc. The arc's endpoints are placed at the endpoints of the source segment and its thickness is taken from the source object's line thickness. The source segment is not removed following conversion, but remains selected so that it can be easily deleted if desired.

Text objects

Graphical text may be placed by using the **T** button in the right toolbar or by keyboard shortcut **Ctrl** + **Shift** + **T**. Activating the tool brings up a text properties dialog. After configuring the text and its properties and accepting the dialog, you can click in the canvas to place the text.

You can also add text boxes, which are similar to regular text except that they have an optional border and they automatically reflow text within that border. Text boxes are placed with the  button, and require clicking twice to specify the top left and bottom right corners of the box.

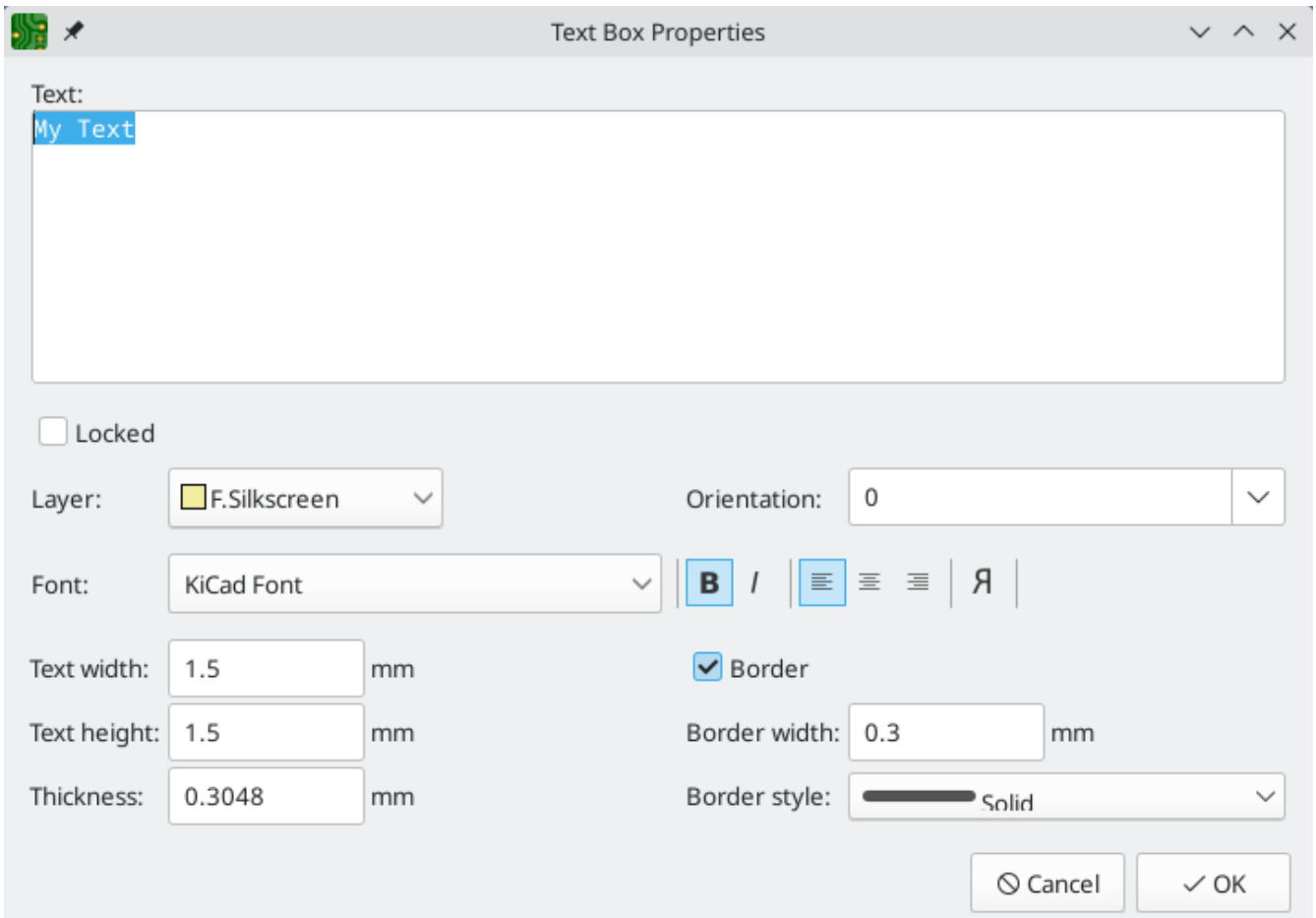

- **Locked** controls whether or not the text object is [locked](#). Locked objects may not be manipulated or moved, and cannot be selected unless the **Locked Items** option is enabled in the Selection Filter panel.
- **Layer** controls the text's layer. Text may be placed on any layer, but note that text on copper layers cannot be associated with a net and cannot form connections to tracks or pads. Copper zones will fill around the rectangular bounding box of text objects.
- There are several formatting options: text can be bolded, italicized, left/right/center aligned, and reversed. Regular text objects (not text boxes) can also have their vertical alignment adjusted. The **knockout** option, which is also limited to regular text objects, adds a solid rectangle surrounding the text and makes the text itself a negative cutout.
- The **Font** dropdown lets you select a font for the text. You can use any TTF font available on your system, or the built-in KiCad stroke font.

NOTE

User fonts are not embedded in the project. If the project is opened on another computer that does not have the selected font installed, a different font will be substituted. For maximum compatibility, use the KiCad font. Also consider converting text objects to polygons before sharing a project (right click a text object → **Create from Selection** → **Create Polygon from Selection...**). Text converted to polygons is not editable as text, but will render identically on any computer.

- You can adjust the text size with the **text width** and **text height** controls. When you are using the KiCad font, you can also adjust the stroke width with the **thickness** control.
- **Position X** and **position Y** control the text object's location. These properties are not available for text boxes.

Orientation is the rotation angle of the text object. You can select an angle in 90 degree increments from the dropdown, or type in an arbitrary angle.

- Text boxes additionally have options controlling their border. The **border** checkbox makes the border visible or invisible. For visible borders, you can adjust the border's thickness with the **border width** control and the line style with the **border style** control (solid, dashed, dotted, dash-dot, or dash-dot-dot). You can also adjust the padding on each side of text in a text box (padding can be set using the [Properties Manager](#), but not using the Text Box Properties dialog).

NOTE

You can customize the default style of newly-created text objects in the Text & Graphics Defaults section of the Board Setup dialog.

Finally, text supports markup for superscripts, subscripts, overbars, evaluating project variables, and accessing symbol field values.

功能	标识语法	结果
上标	<code>text^{superscript}</code>	<code>text^{superscript}</code>
下标	<code>text_{subscript}</code>	<code>text_{subscript}</code>
上划线	<code>~{text}</code>	<code>text</code>
变量	<code>\${variable}</code>	变量值
符号字段	<code>\${refdes:field}</code>	<i>field_value</i> of symbol <i>refdes</i>

NOTE

变量必须在 [电路板设置](#) 中定义, 才可以使用。也有一些 [内置文本变量](#)。

Tables

You can use a table to organize text in a tabular format. Tables have customizable borders, cell sizes, and headers, and can be placed on any layer.

Heading 1	Heading 2
Column 1 Row 1	Column 2 Row 1
Column 1 Row 2	Column 2 Row 2

To place a table, use the  button in the right toolbar. Click in the canvas to place the top left corner of the table, then click again to place the bottom right corner of the table and finish drawing the table. The bigger you draw the table, the more rows and columns will be added by default, but rows and columns can be added or deleted after the table is created.

Editing table properties

When you finish drawing a table, the Table Properties dialog appears. You can also open the Table Properties dialog in several other ways:

- Select any cell in the table, right click, and select **Edit Table** (**Ctrl** + **E**)
- Select the entire table, right click, and select **Properties...** (**E**). You can select the entire table with a drag selection or by selecting a single cell, then right clicking and selecting **Select Table**.
- Click the **Edit Table...** button in the Table Cell Properties dialog.

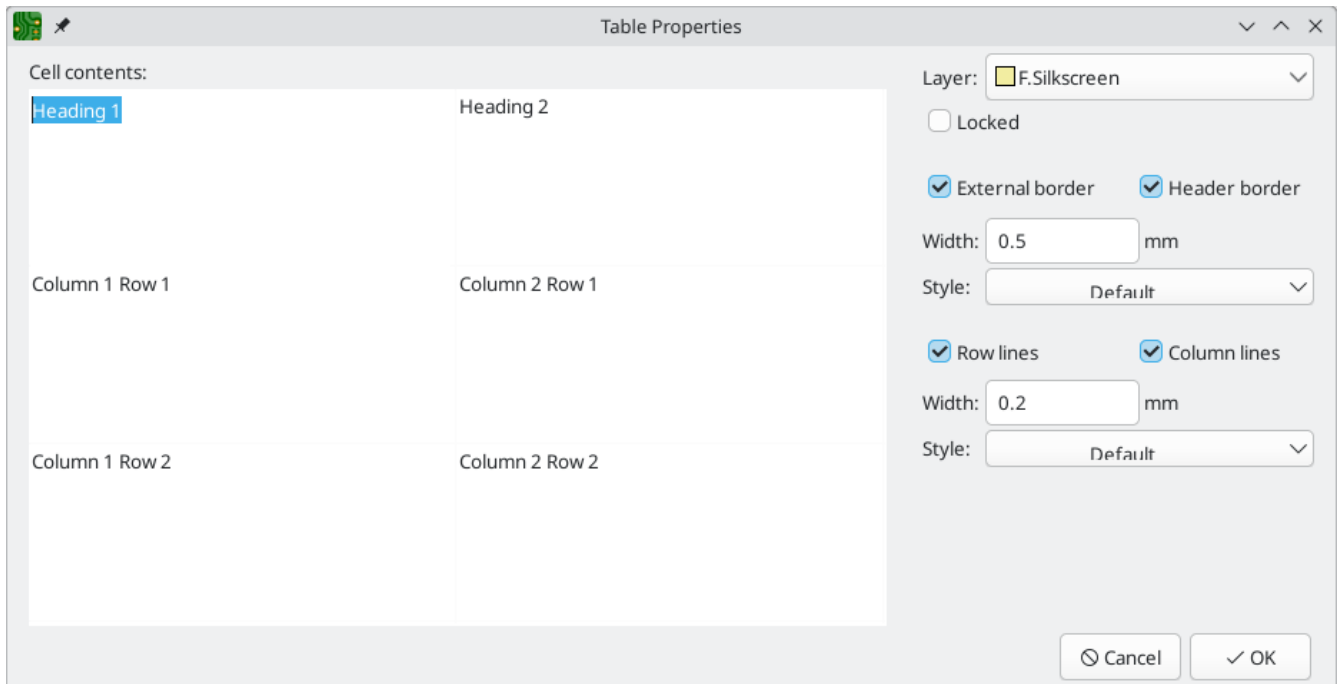

This dialog lets you edit the properties of the entire table, including the text in each cell and the separators between cells. To change the formatting of text in a cell, edit the properties of individual cells, instead of the properties for the entire table.

NOTE

The properties for a table can also be edited in the [Properties Manager](#) when the entire table is selected.

The left side of the dialog displays an editable grid of the entire table. You can edit the contents of any cell by clicking on the cell in the grid. You can also edit the text in a cell by selecting the cell and using the Properties Manager.

NOTE

Text in table cells supports the markup described in the [text objects section](#) (superscripts, subscripts, strikethroughs, etc.).

The right side of the dialog contains formatting options for the table.

- The **Layer** dropdown controls which board layer the table is on.
- The **Locked** checkbox controls whether or not the table is [locked](#). Locked objects may not be manipulated or moved, and cannot be selected unless the **Locked Items** option is enabled in the Selection Filter panel.

The **External border** and **Header border** checkboxes control whether there is a border drawn around the entire table and the cells in the top row, respectively. When **Header border** is enabled, the border below the cells in the top row is styled using these external border settings rather than the row/column line settings. The line width of the header borders is controlled by the **Width** field. The line style can be set to solid, dashed, dotted, dash-dot, or dash-dot-dot using the **Style** dropdown menu.

- The **Row Lines** and **Column lines** checkboxes enable horizontal lines between rows and vertical lines between columns, respectively. These have the same formatting options as the external and header borders.

Editing table cell properties

Instead of editing the properties of an entire table, you can also edit the properties of individual cells. This modifies selected cells, but does not affect other cells. To open the Table Cell Properties dialog, double click on a cell, or select a cell, right click, and choose **Properties...** (E). If you select multiple cells, the properties dialog will act on all of them at once.

NOTE You can select multiple cells by clicking and dragging.

NOTE To select all cells in a row or column, select a cell in that row or column, right click, and choose **Select Row(s)** or **Select Column(s)**. You can select multiple rows or columns in this way by starting with multiple cells selected.

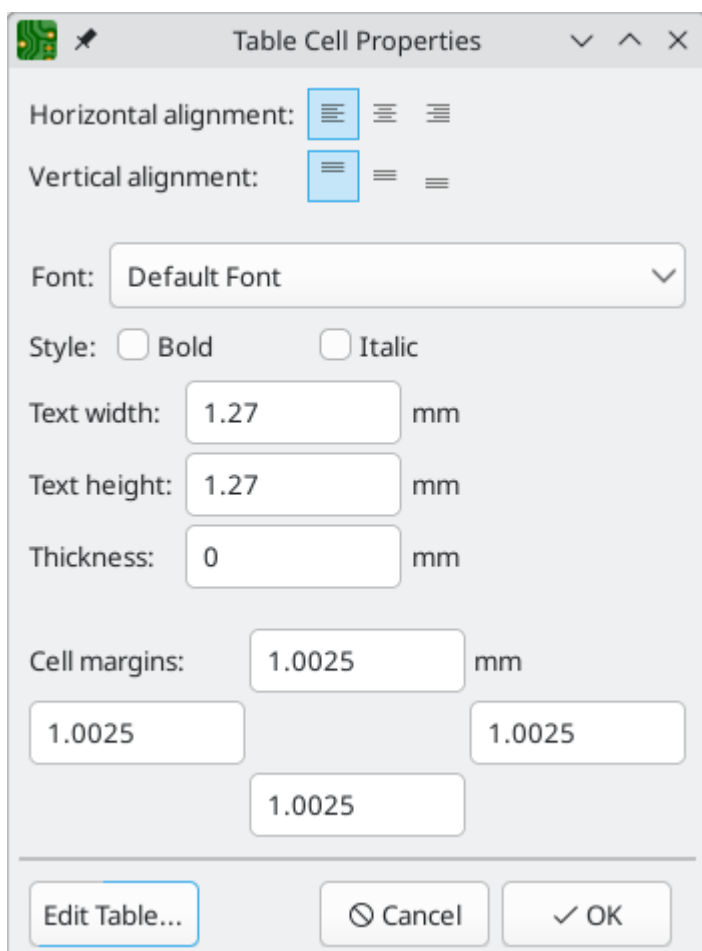

This dialog contains formatting options for the text in each cell.

- **Horizontal alignment** and **Vertical alignment** control how text is positioned within the cell.

- **Font** controls the text font used in the cell.
- The **Bold** and **Italic** checkboxes bold and italicize the text, respectively. These are three-state checkboxes, which can be set to off, on, or no change. No change is useful when multiple cells with different bold/italic settings are being edited at the same time.
- The **Text width**, **Text height**, and **Thickness** control the size and thickness of the text. **Thickness** only has an effect when the font is set to the KiCad Font.
- The **Cell margins** textboxes control the amount of spacing around the top, bottom, left, and right of the text in the cell.

You can click the **Edit Table...** button to open the properties dialog for the entire table.

NOTE

The properties for a table cell can also be edited in the [Properties Manager](#) when one or more table cells is selected.

Editing table layout

The layout of a table (size and number of columns and rows) is initially set when you create a table, but you can also edit the layout after creation.

To resize a row or column, select a cell in that row or column, then drag the handle on the right (to change the column width) or the bottom (to change the row height) to the desired size.





To add rows or columns, select a cell next to where the new row or column should go, right click, then choose **Add Row Above**, **Add Row Below**, **Add Column Before**, or **Add Column After**, as desired.

To delete rows or columns, select a cell in the row or column you want to delete, then right click and choose **Delete Row(s)** or **Delete Column(s)**. To delete multiple rows or columns, start with a selection that spans all the rows or columns you want to delete.

You can merge multiple cells into a single cell by selecting all the cells you want to merge, right clicking, and choosing **Merge Cells**. To unmerge them, select the merged cell, right click, and choose **Unmerge Cells**.

尺寸标注

尺寸标注是用于显示测量值或电路板设计上的其他标记的图形对象。它们可以被添加到任何绘图层中，但通常被添加到某个用户层。KiCad 目前支持五种不同类型的标注：对齐、正交、中心、径向和引线。

- **Aligned** dimensions () show a measurement of distance between two points. The measurement axis is the line that connects those two points, and the dimension graphics are kept parallel to that axis.
- **Orthogonal** dimensions () also measure the distance between two points, but the measurement axis is either the X or Y axis. In other words, these dimensions show the horizontal or vertical component of the distance between two points. When creating orthogonal dimensions, you can select which axis to use as the measurement axis based on where you place the dimension after selecting the two points to measure.
- **Center** dimensions () create a cross mark to indicate a point or the center of a circle or arc.
- **Radial** dimensions () show a measurement between a center point and the outside of a circle or arc. The center point is indicated by a cross.

Leader dimensions () create an arrow with a leader line connected to a text field. This text field can contain any text, and an optional circular or rectangular frame around the text. This type of dimension is often used to call attention to parts of the design for reference in fabrication notes.

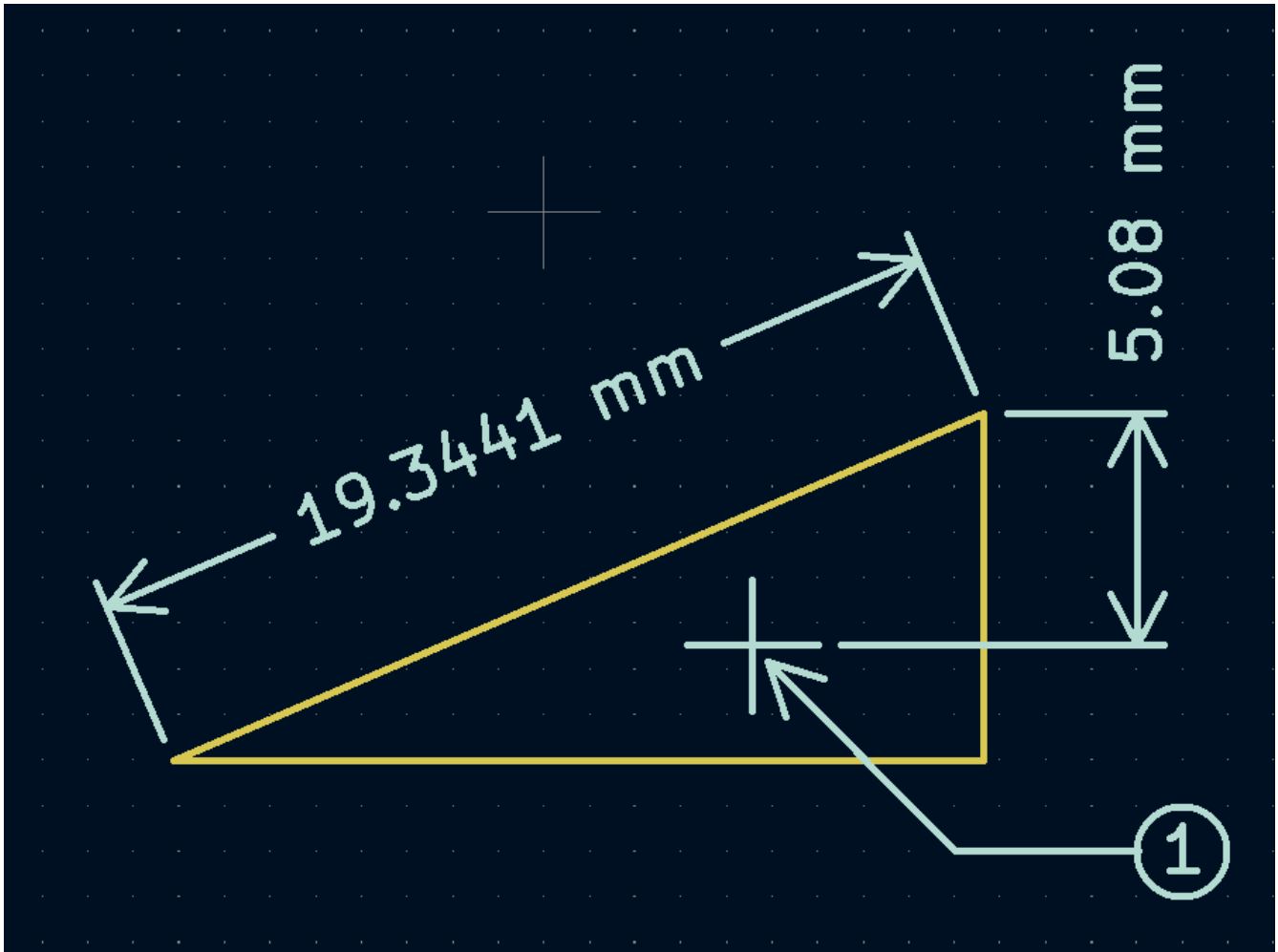

创建一个尺寸标注后，可以编辑其属性（快捷键 ）以改变显示数字的格式以及文本和图形线的风格。

NOTE

You can customize the default style of newly-created dimension objects in the Text & Graphics Defaults section of the Board Setup dialog.

标注属性
✕

标注格式

值: 覆盖值 单位:

前缀:

后缀:

层:

单位格式:

精度:

隐藏尾随零

预览: 115.5700 mm

标注文本

宽度: mm 位置 X: mm

高度: mm 位置 Y: mm

粗细: mm 位置模式:

斜体 方向:

镜像 与标注保持对齐

对齐:

标注线

线粗细: mm 箭头长度: mm

尺寸界线偏移: mm

尺寸标注格式选项

- **Override value:** When enabled, you may enter a measurement value directly into the **Value** field that will be used instead of the actual measured value.
- **Prefix:** Any text entered here will be shown before the measurement value.
- **Suffix:** Any text entered here will be shown after the measurement value.
- **Layer:** Selects which layer the dimension object exists on.
- **Units:** Selects which units to display the measured value in. **Automatic** units will result in the dimension units changing when the display units of the board editor are changed.
- **Units format:** Select from several built-in styles of unit display.
- **Precision:** Select how many digits of precision to display.

尺寸标注文本选项

大多数尺寸标注文本选项与其他图形文本对象的选项相同（见上面的图形对象部分）。也有一些特殊的选项适用于尺寸标注文本：

- **Position mode:** Choose whether to position the dimension text manually, or to automatically keep it aligned with the dimension measurement lines.

Keep aligned with dimension: When enabled, the orientation of the dimension text will be adjusted automatically to keep the text parallel with the measurement axis.

尺寸标注线选项

- **Line thickness:** Sets the thickness of the graphical lines that make up a dimension's shape.
- **Arrow length:** Sets the length of the arrow segments of the dimension's shape. A negative arrow length reverses the arrow direction.
- **Extension line offset:** Sets the distance from the measurement point to the start of the extension lines.
- **Extension line overshoot:** Sets the distance from the dimension's line to the end of the extension lines.

引线选项

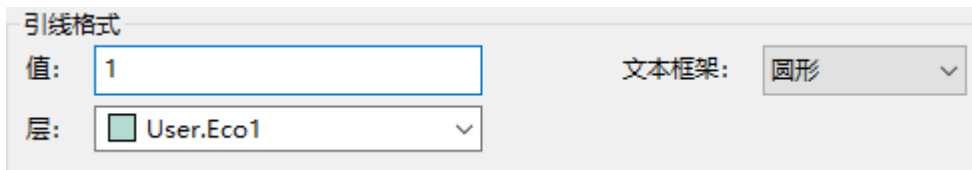

引线格式

值: 文本框架:

层:

- **Value:** Enter the text to show at the end of the leader line.
- **Text frame:** Select the desired border around the text (circle, rectangle, or none).

批量编辑文本和图形

Properties of text and graphics, including dimensions, can be edited in bulk using the **Edit Text and Graphics Properties** dialog (**Edit** → **Edit Text & Graphic Properties...**).

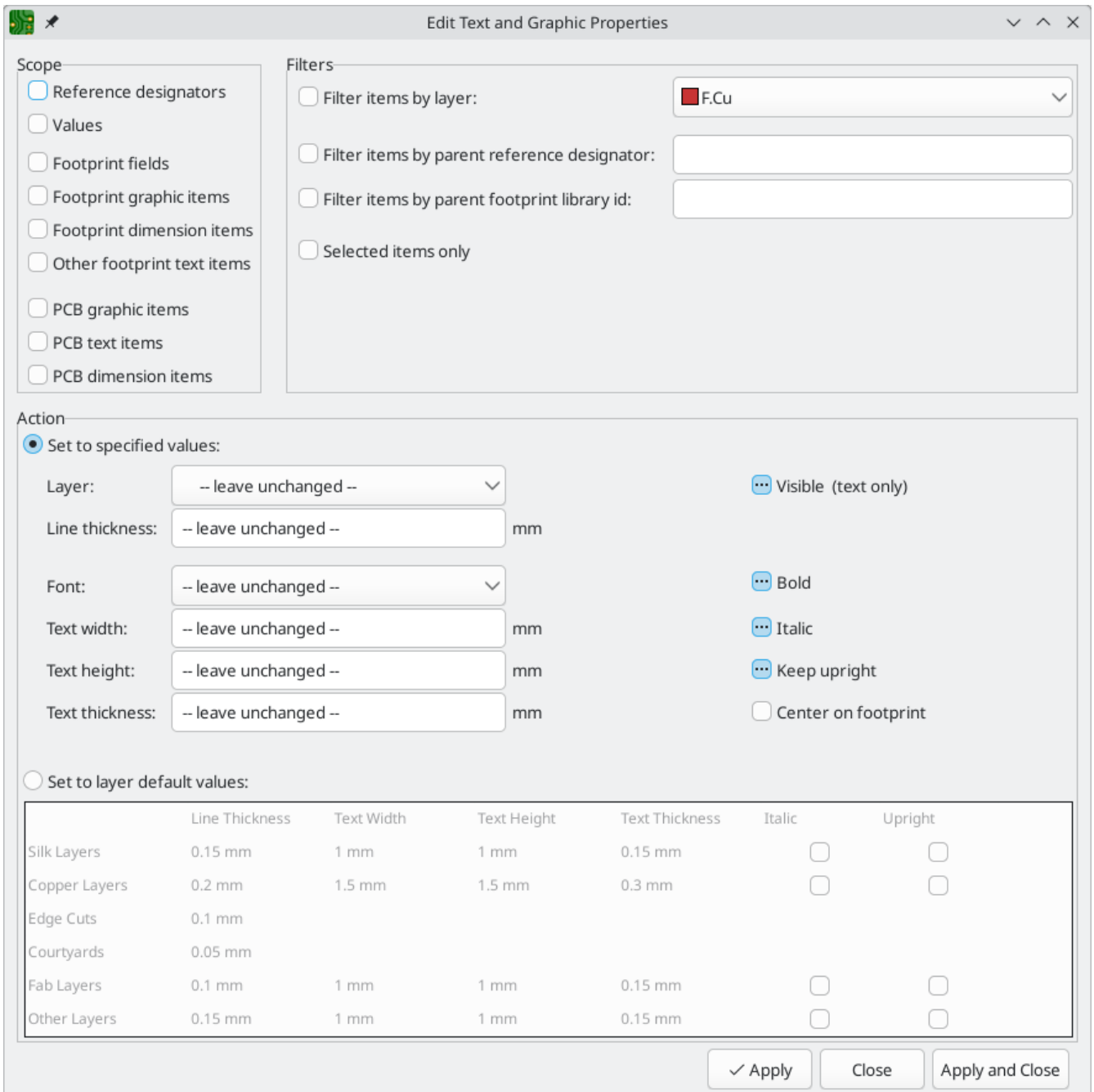

范围和筛选器

Scope settings restrict the tool to editing only certain types of objects. If no scopes are selected, nothing will be edited.

Filters restrict the tool to editing particular objects in the selected scope. Objects will only be modified if they match all enabled and relevant filters (some filters do not apply to certain types of objects. For example, parent footprint filters do not apply to graphic items and are ignored for the purpose of changing graphic properties). If no filters are enabled, all objects in the selected scope will be modified. For filters with a text box, wildcards are supported: `*` matches any characters, and `?` matches any single character.

- **Filter items by layer** filters to items on the specified board layer.
- **Filter items by parent reference designator** filters to fields in the footprint with the specified reference designator. **Filter items by parent footprint library id** filters to fields in footprint with the specified library identifier.

Selected items only filters to the current selection.

操作

被筛选对象的属性可以在对话框的底部设置为新的值。通过选择 **设置为指定值**，可以将属性设置为任意值，或者通过选择 **设置为图层默认值**，将属性重置为其图层的默认值。

下拉列表和文本框可以被设置为 **--保持不变--** 以保留现有值。复选框可以被选中或不被选中，以后用或禁用某个变化，但也可以切换到第三种 "保持不变" 状态。

- 所有项目都可以设置其 **层**。
- 图形对象可以修改其 **线的粗细**。
- Text properties that can be modified are **font**, **text width**, **text height**, **text thickness** (KiCad font only), emphasis (**bold** and **italic**), orientation (**keep upright**), and alignment (**center on footprint**). Footprint text can also have its **visibility** set.

Cleaning up graphics

There is a dedicated tool for performing common cleanup operations on graphics, which is run via **Tools** → **Cleanup Graphics...**

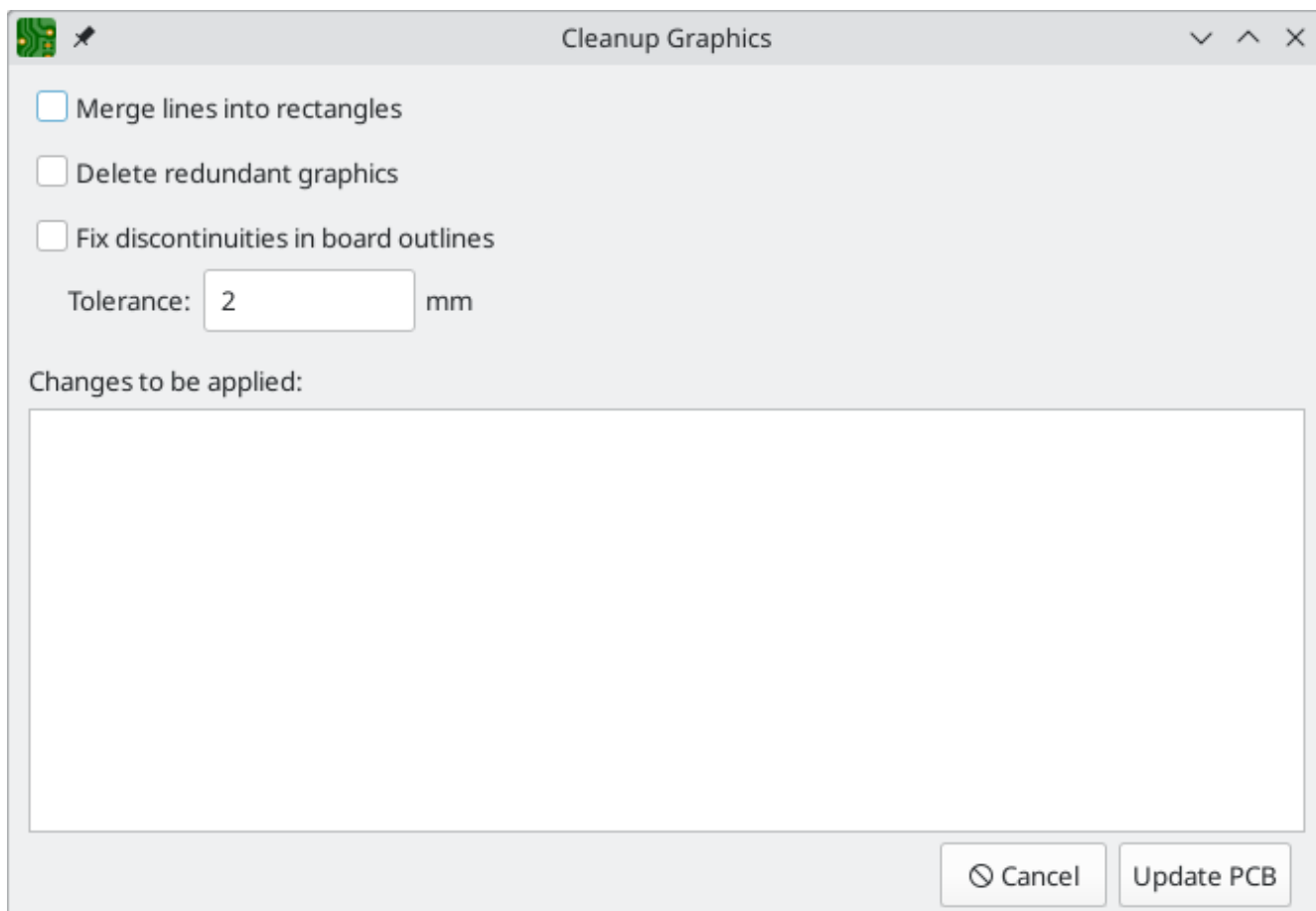

The following cleanup actions are available and will be performed when selected:

- **Merge lines into rectangles:** combines individual graphic lines that together form a rectangle into a single rectangle shape object.
- **Delete redundant graphics:** deletes graphics objects that are duplicated or degenerate.

Fix discontinuities in board outlines: modifies the existing board outline to fix any discontinuities that are within the specified tolerance.

Any changes that will be applied to the board are displayed at the bottom of the dialog. They are not applied until you press the **Update PCB** button.

Rule areas (keepouts)

Rule areas, also known as keepouts, are board regions that can have specific DRC rules defined for them. Some basic rules are available that will raise DRC errors if certain types of objects are within the bounds of the rule area, but rule areas can also be used together with [custom DRC rules](#) to define complex DRC behavior that only applies within the rule area. Rule areas are also used to define channels for [multichannel layout](#).

You can add a rule area by clicking the  button on the right toolbar (**Ctrl** + **Shift** + **K**). Click on the canvas to place the first corner, which will show the Rule Area Properties dialog. After configuring the rule area appropriately, press **OK** to continue placing corners of the rule area. The rule area shape can be an arbitrary polygon; click on the starting corner or double click to finish placing the rule area.

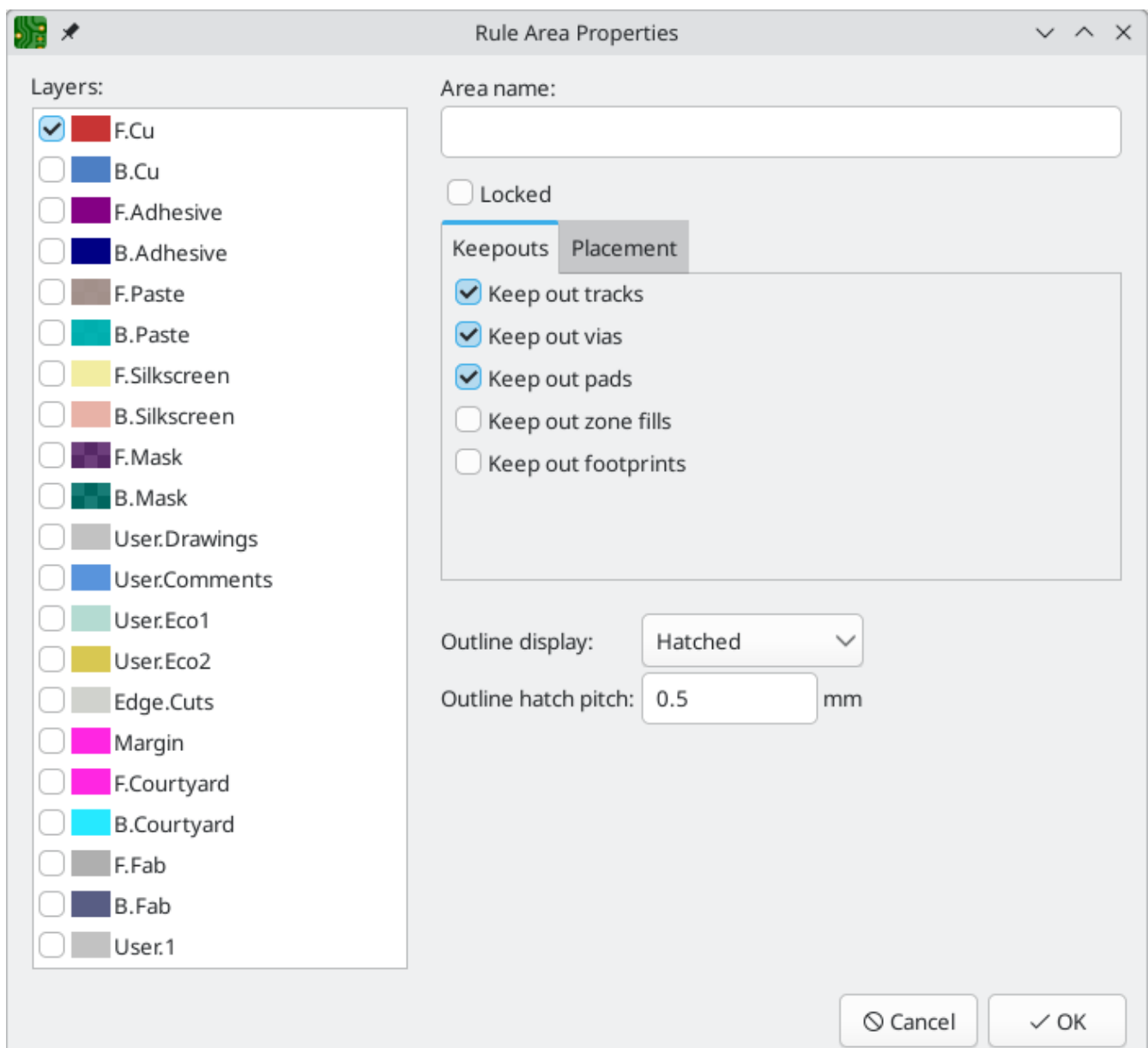

The Rule Area Properties dialog has the following options:

- The **layers** list determines which layers the rule area applies to. The area only appears on these layers and the selected keepout rules only apply on these layers. At least one layer must be selected. By default, the active layer in the editing canvas is preselected in the rule area layer list.
- The **area name** field is optional and provides an identifier for the rule area. If it is provided, it is included in DRC violation messages to make them clearer. It can also be used in custom DRC rules to identify a particular rule area.
- The **locked** checkbox determines if the rule area should be **locked**. As with other objects, rule areas can also be locked or unlocked after they are created.
- The **Keepouts** tab contains several basic rules to prevent various types of objects from being placed within the rule area. The basic rules can be configured to keep out tracks, vias, pads, zone fills, and/or footprints. If an object of one of the selected types is within the rule area, a DRC error will be raised. Additionally, zone fills will automatically avoid a rule area if the rule area is configured to keep out zones.

NOTE

Even with no basic rules selected, rule areas can still be used to define specific areas in which to apply [custom DRC rules](#).

- The **Placement** tab contains settings for [multichannel layout](#), which are explained in that section.
- There are a few options for the **outline display** of the rule area. The area can be shown with a hatched outline, fully hatched throughout the area, or with just the outline with no hatching. The **outline hatch pitch** is also adjustable.

锁定

Most objects can be locked through their properties dialogs, by using the right-click context menu, or by using the Toggle Lock hotkey (**L**). Locking an item makes it more difficult to select, move, or modify the object, which can prevent unintended modifications. Locked objects cannot be selected unless the "Locked items" checkbox is enabled in the selection filter. Attempting to move locked items will result in a warning dialog:

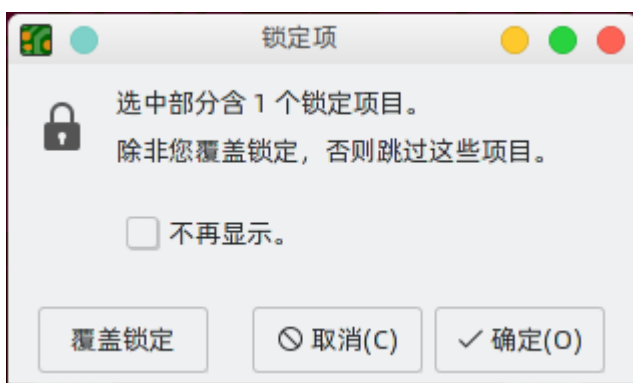

在这个对话框中选择 "覆盖锁定" 将允许移动锁定的项目。选择 "确定" 将允许你在选中对象中移动任何未上锁的对象；留下锁定的对象。选择 "不再显示" 将使你在剩下的会话中记住你的选择。

NOTE

You can forget this choice and re-enable the lock override prompt for the current session by unchecking **Do not prompt for lock overrides for this session** in the **Editing Options** panel of the PCB Editor Preferences dialog.

Locked items are displayed with a colored shadow around them. This can be customized in your color scheme.

NOTE

Locked objects can't be selected unless the **Locked items** checkbox is enabled in the [selection filter](#). By default, this checkbox is disabled to exclude locked items from selection.

Groups

Groups let you treat multiple objects as a single object for the purposes of moving or rotating them. Each object in the group will maintain its position relative to the other objects in the group. Groups can also have a name, which is displayed in the editing canvas when the group is selected.

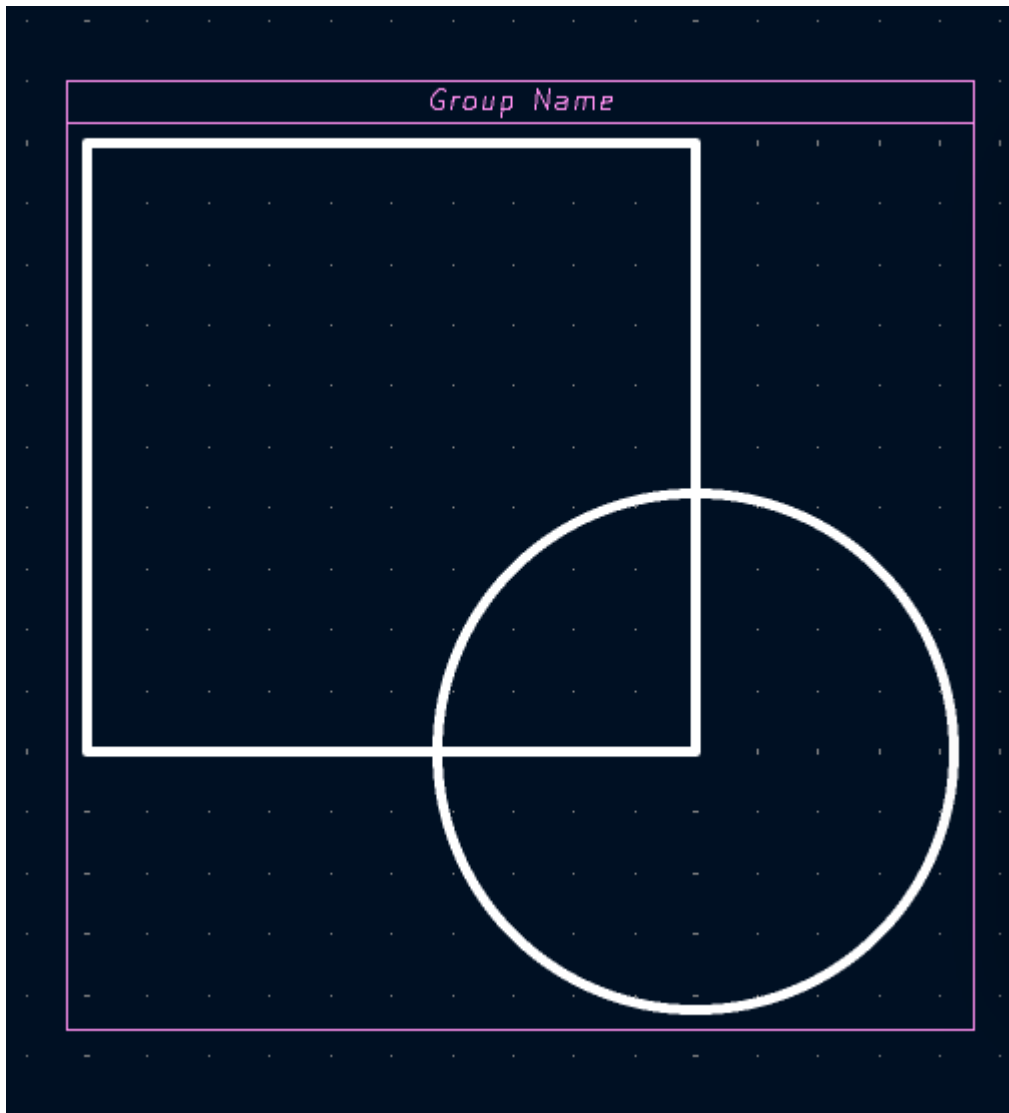

Most types of objects in the Board Editor can be grouped: footprints, tracks, zones, graphic items, and even other groups. Groups can contain multiple different types of objects at once.

To add objects to a group, select them, then right click and choose **Grouping** → **Group Items**. To remove all items from a group, select the group, right click, and choose **Grouping** → **Ungroup Items**.

Once objects have been added to a group, selecting any of the objects will select the group as a whole instead of the constituent objects. To edit a specific object within a group, first select the group, right click and choose **Enter Group**. Double clicking on a group also enters the group. When a group has been entered, objects within the group can be selected and edited individually without affecting the other objects in the group. To leave the group and stop editing its members individually, right click and select **Leave Group**, select an object outside the group, or use Esc.

There are several ways to modify which objects belong to a group. To remove objects from an existing group, enter the group, then select the objects you want to remove, right click, and choose **Grouping** → **Remove Items**. To add items to a group, first ungroup all the items from the group. This will leave the group's former members selected. Then add the new item to the selection and group the selection. Note that without first ungrouping, this process would create a nested group: a new group containing the new item and the entire original group, not just the items in the original group.

You can also add or remove objects from a group in the group's properties dialog. To open a group's properties dialog, press E or right click and click **Properties...** The properties dialog lists the objects contained in the group. To add an additional object to the group, click the **+** button, then click on the desired object in the editing canvas. The object you click on will be added to the group. To remove an object, select it in the list, then click the **🗑** button.

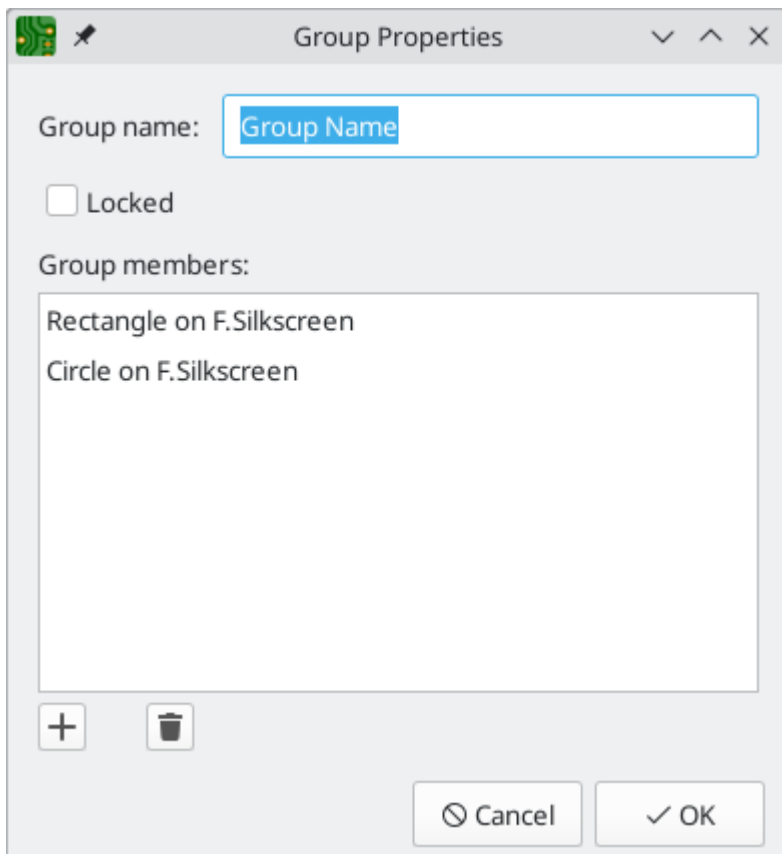

The group properties dialog also lets you specify a name for the group or **lock** the group. Groups can also be named or locked using the [Properties Manager](#).

Aligning objects

The align tool moves a selection of objects so that they are all aligned with a reference object. There are six different alignments to choose from, depending on which part of the objects you wish to align. Objects can be horizontally aligned by their left, center, or right edges, or they can be vertically aligned by their top,

center, or bottom edges. Objects are only moved in one dimension, so objects stay in the same horizontal position when aligned vertically, and vice versa. To align objects by a given edge, select the objects, then right click and choose **Align/Distribute** → **Align to Left** (or another alignment as desired).

If the cursor is over an object in the selection, that object is used as the reference object. Otherwise, the reference object is the object in the selection which is located furthest in the alignment direction, for example the leftmost object when aligning by left edge, or the topmost object when aligning by top edge. The topmost object is used when aligning by vertical center, and the leftmost when aligning by horizontal center.

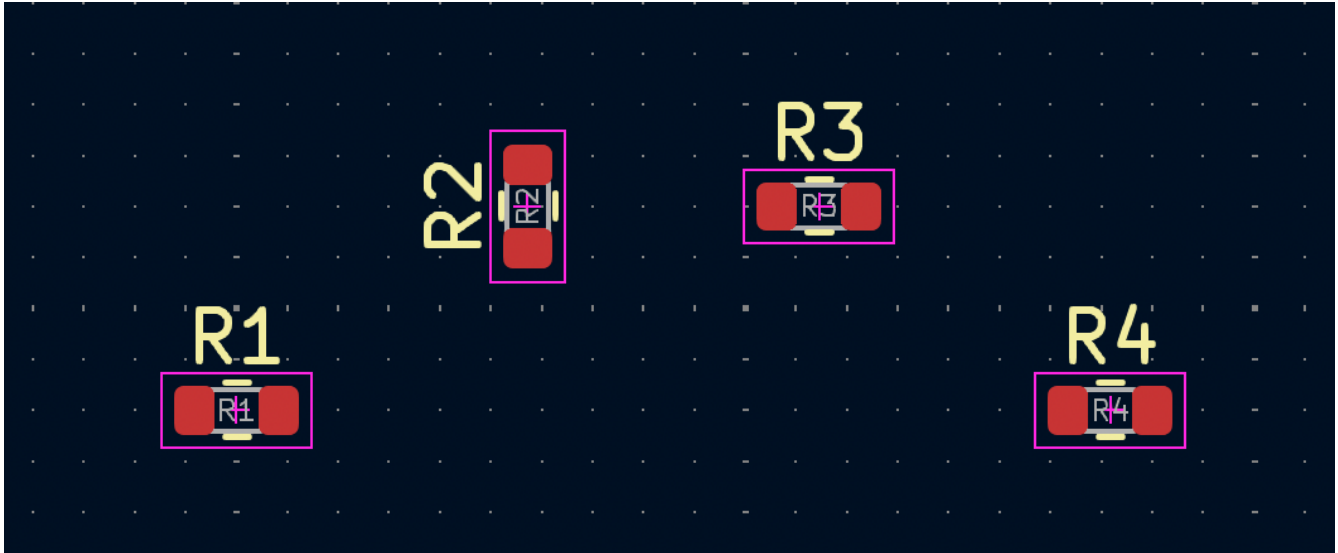

Before alignment

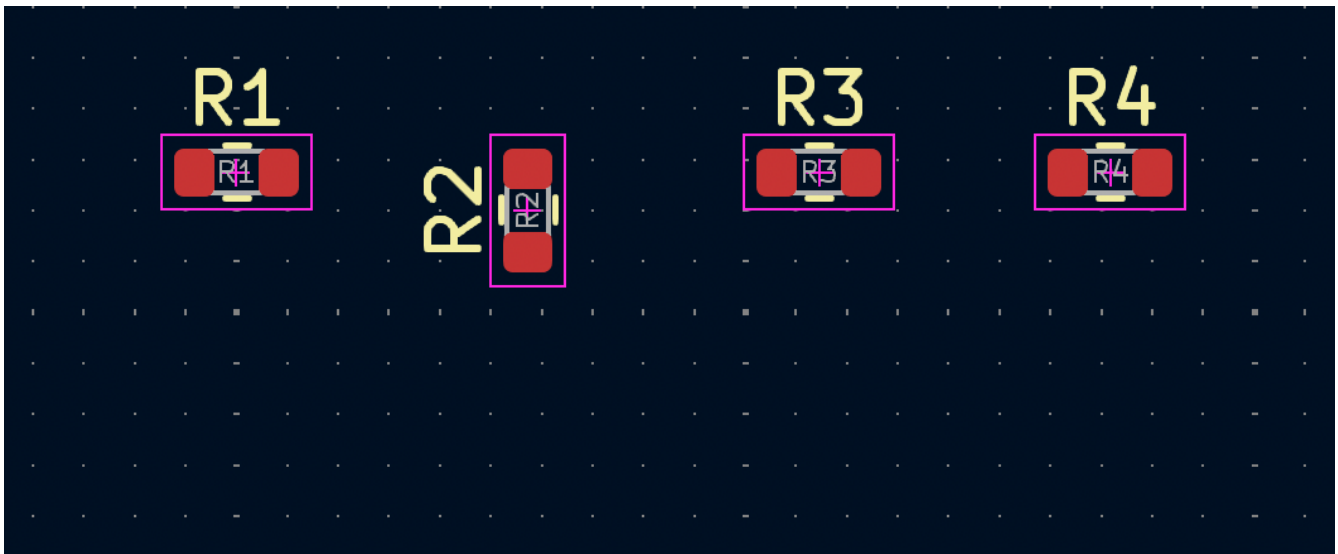

After alignment

In the example above, R1-R4 are vertically aligned by their top edges, with R2 as the reference object. The first image shows them before alignment and the second image shows them after alignment. In this case, R2 is the topmost object before alignment, so it is chosen as the reference object if the cursor is not over another resistor. After alignment, the top edges of the resistors are at the same position, but the horizontal positions of the resistors are unchanged.

Distributing objects

You can use the distribute tool to move objects so they are evenly spaced from each other (right click a selection → **Align/Distribute** → **Distribute Horizontally** or **Distribute Vertically**). The two outermost objects in the selection are not moved. This means the top and bottom objects when distributing vertically, and the leftmost and rightmost objects when distributing horizontally. The remaining objects in the selection are evenly distributed between the outermost objects and maintain their relative ordering. Objects are only moved in one dimension, so objects stay in the same horizontal position when distributed vertically, and vice versa.



Before distribution



After distribution

In the example above, R1-R4 are horizontally distributed. The first image shows them before distribution and the second image shows them after distribution. R1 and R4 are the leftmost and rightmost objects, so they are not moved. R2 and R3 are moved so the horizontal spacing between resistors is equal, but the vertical positions remain unchanged. From left to right, R1-R4 are in the same order that they were in before distribution.

Arrays

KiCad has an array tool to create rectangular or circular arrays of objects (footprints, vias, graphical objects, etc.). Two types of array are possible: **Grid** and **Circular**.

☰
Create Array
✕

Grid Array Circular Array

Grid Array Size

Horizontal count:

Vertical count:

Items Spacing

Horizontal spacing: mm

Vertical spacing: mm

Horizontal offset: mm

Vertical offset: mm

Stagger Settings

Stagger:

Rows

Columns

Grid Position

Source items remain in place

Centre on source items

Footprint Annotation

Keep existing reference designators

Assign unique reference designators

Cancel
OK

Grid Arrays are rectangular and are described by a **horizontal count** and a **vertical count**, which set the number of columns and rows in the array, respectively. The **horizontal** and **vertical spacing** settings describe the distance between columns and rows, while the **horizontal** and **vertical offset** settings describe a shift applied to each row/column compared to the previous row/column.

You can create a repeating staggered pattern by choosing a **stagger** setting, which controls the number of rows or columns that are offset before the pattern repeats. You can stagger by **row** or by **column**. For example, if two staggered rows are selected, each row will be horizontally offset from the previous row by half of the array's horizontal spacing setting. Every other row will be placed at the original spacing and offset. If three staggered columns are selected, each column will be vertically offset by a third of the array's vertical spacing setting. Every third column will be placed at the original spacing and offset. Offsets from the stagger settings are added to the previous horizontal and vertical offset settings.

If the **grid position** option is set to **source items remain in place**, the original items will not be moved, and the grid extends with those items at one corner. If **center on source items** is chosen, the grid is offset so that the resulting grid is centered where the items used to be.

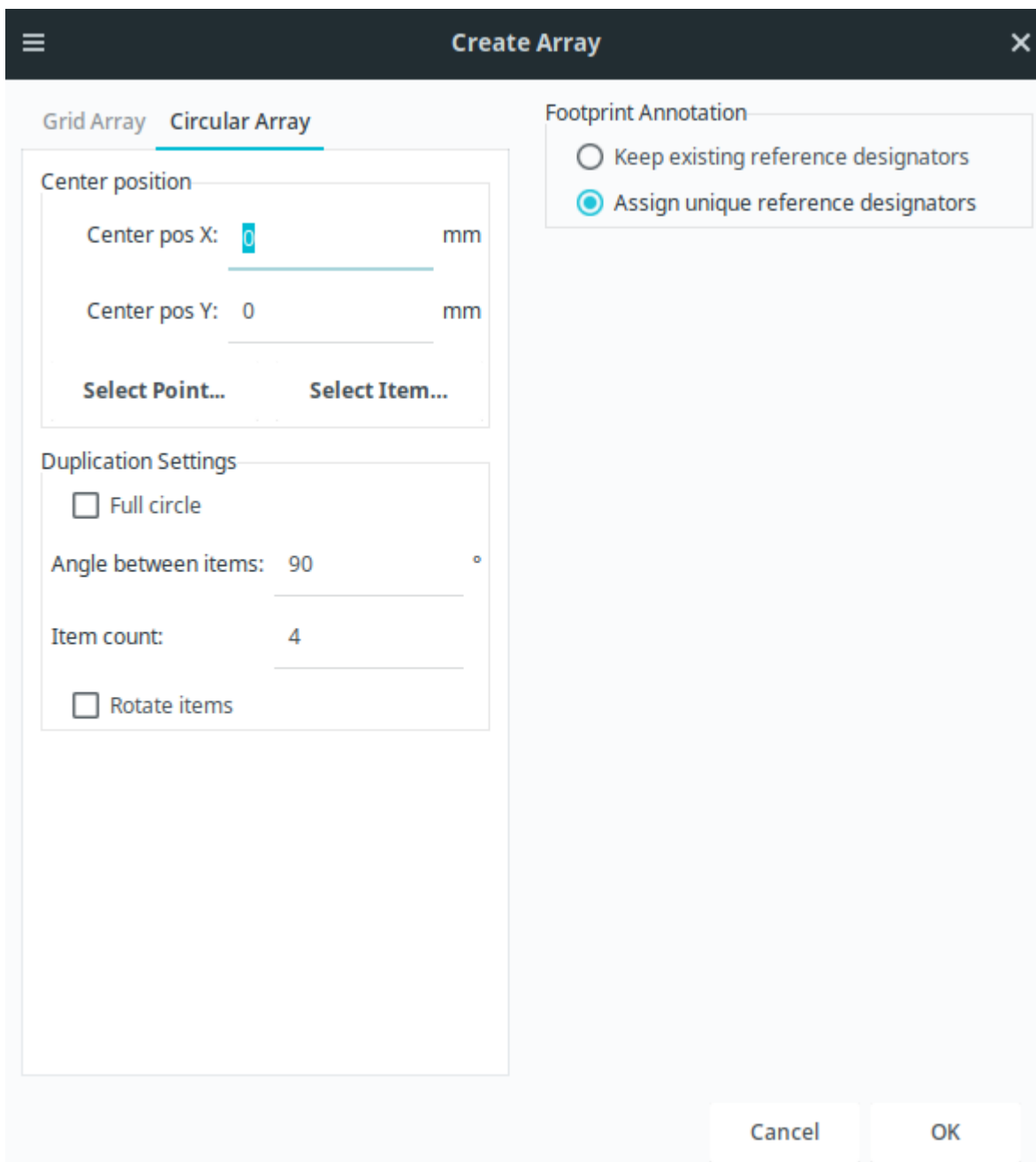

Circular Arrays are described by a center point, an angular spacing, and, optionally, the number of arrayed items. If **set center by position** is selected, the center point of the array will be defined by the absolute X/Y position you enter in **center pos X** and **center pos Y**. You can also interactively select a point from the board using **Select Point...**, or select the origin point of another item using **Select Item...**

The **item count** field determines the number of objects in the array, including the source object. The **angle** field determines the angular spacing between items, with the center point at the center of the array. Positive angles result in a counter-clockwise rotation relative to the center point and the source item, while negative angles result in a clockwise rotation. Select **full circle** to evenly space the entered number of items around the circle.

When **rotate items** is selected, objects will be rotated around their origins as array sweeps around the center point. Otherwise, objects will maintain the same orientation as the source item.

When creating an array of footprints, whether rectangular or circular, the **Footprint Annotation** settings control how the reference designators will be set in the new footprints. This affects the linkage of the new

footprints to the schematic. If **keep existing reference designators** is selected, the new footprints in the array will have the same reference designators as the source footprints, resulting in duplicated reference designators in the board. If **assign unique reference designators** is selected, each new footprint created in the array will have a unique reference designator automatically assigned.

NOTE

Creating an array of footprints will result in multiple copies of the source footprint(s). If you are using a schematic-based workflow, this will result in footprints that are not represented in the schematic, so careful syncing between the board and the schematic will be needed.

Multichannel layout

KiCad has a multichannel layout feature for easing designs that have multiple repetitive subcircuits, like an audio mixer with many identical channels. This feature lets you perform placement and routing for one portion of a circuit, then automatically reuse that placement and routing for the other repeated portions of the circuit.

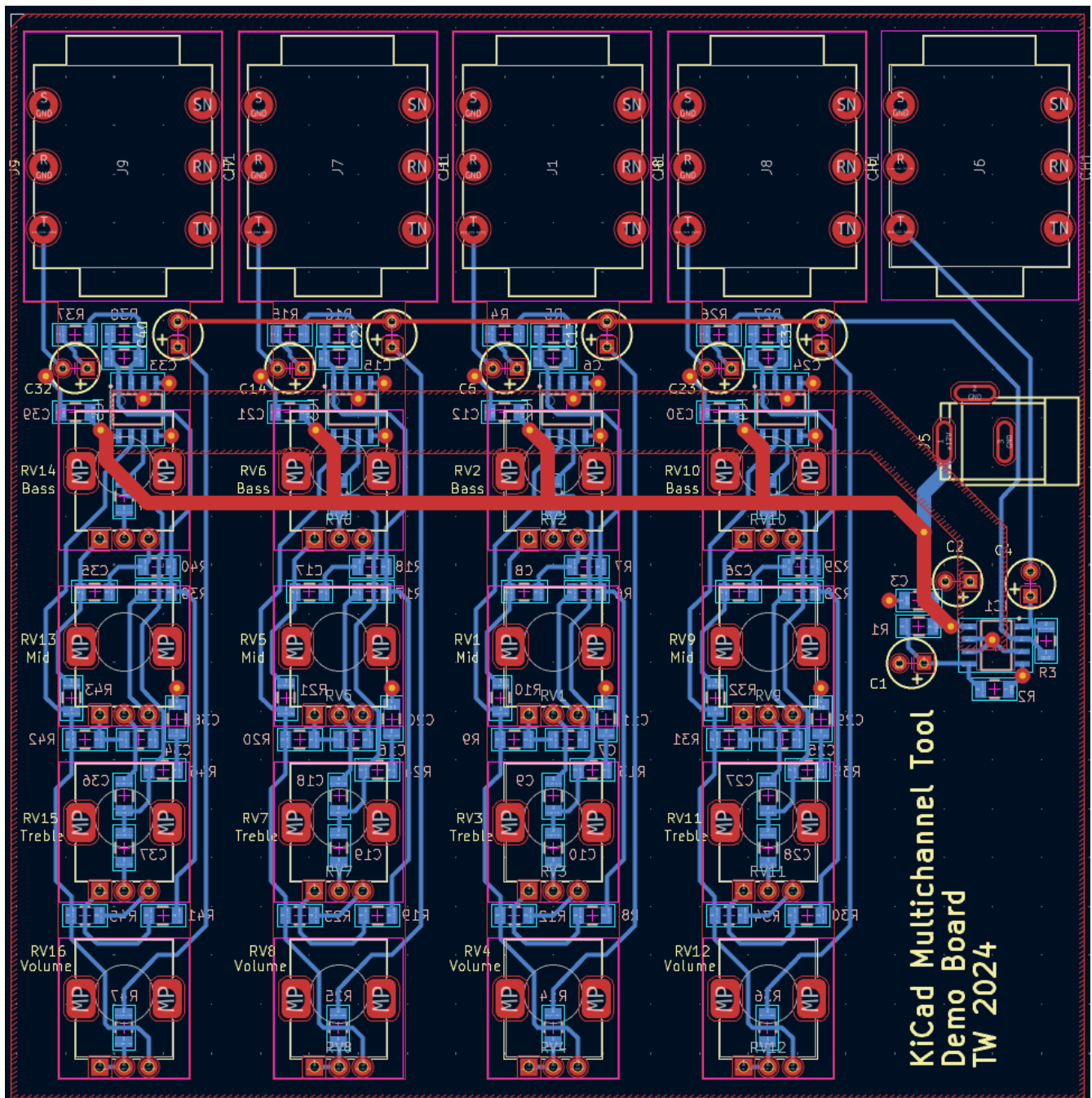

Using the multichannel layout feature first requires you to designate which portions of the schematic represent the repeated parts of the circuit. You can either use [hierarchical sheets](#), with a repeated hierarchical sheet for each channel, or [component classes](#) with a unique component class assigned to the symbols in each channel. Each channel will exactly correspond to the symbols (and their associated connections) in a single sheet or component class.

For the layout, specially configured [rule areas](#) are drawn on the board and used to describe the physical location of each repeated channel. The automatic placement of footprints, routing, and other items is restricted to these placement rule areas. Each "channel" of the design corresponds to a single rule area. One rule area will be the *reference* rule area, which will be manually placed and routed. The other rule areas are the *target* rule areas, which will reuse the placement and routing from the reference rule area.

After setting up the placement rule areas for each channel and manually routing the reference channel, the Repeat Layout tool is used to copy the placement and layout from the reference rule area to the target rule areas.

NOTE

KiCad includes a demo project, called `multichannel`, that demonstrates the use of the multichannel layout feature.

Multichannel design procedure: schematic

Designing a multichannel layout begins in the schematic. You need to specify which components (symbols) belong to each channel. Each channel in the schematic must be equivalent to the other channels. This means channels must match each other in the following ways:

- each matched channel needs to have the same number of symbols
- corresponding symbols in each channel need to have the same reference designator prefix (e.g. R or U), although the full reference designators need to be unique as usual
- corresponding symbols in each channel need to have the same footprint
- connections between symbols need to be equivalent in each channel

In the example schematic below, Channels 1, 2, 3, and 4 are equivalent and therefore can be used to share routing in a multichannel design. Even though the net connections are drawn differently in some channels, the underlying net connections are the same. The different symbols in Channel 2 and the different values in Channel 3 also do not break the equivalency. Footprint assignments are not shown in the image, but the symbols that correspond between channels must use the same footprints. In this example, this means that R1, R3, R5, and R7 each must use the same footprint, as must R2, R4, R6, and R8.

In contrast, Channels A and B are not equivalent to Channels 1-4, nor to each other. Channel A contains an extra parallel resistor not present in the other channels, and Channel B is missing a connection between the two resistors.

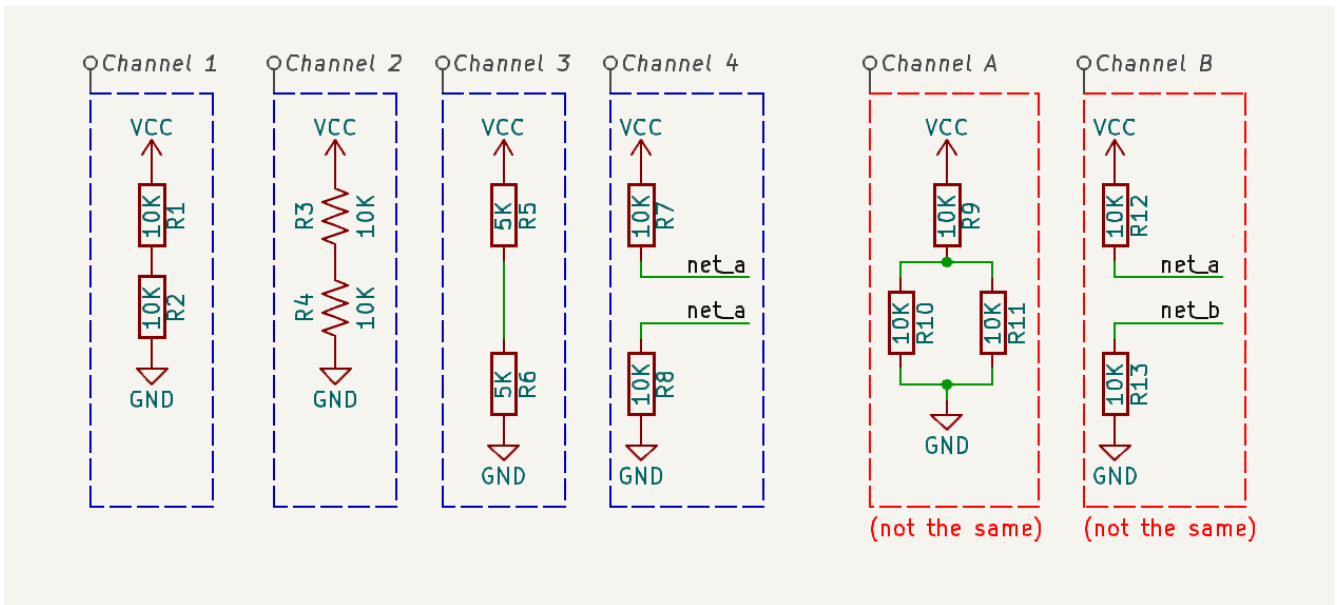

You can assign symbols to channels in two ways, either using [hierarchical sheets](#) or using [component classes](#).

- When doing a multichannel design using hierarchical sheets, each channel is represented by a different sheet. Normally you will instantiate the same hierarchical sheet file multiple times, with one instantiation per channel. Each sheet instantiation needs to include all of the symbols for the corresponding channel, with no extra symbols.
- When doing a multichannel design using component classes, each channel is represented by a different component class. Each component class needs to include all of the symbols for the corresponding channel, with no extra symbols. Component classes are shown in the previous schematic example.

Multichannel design procedure: board

In the board, each channel is represented with a [rule area](#) with its rules configured for placement. You need to add a rule area for each channel. One rule area will be the *reference*, containing manually placed and routed footprints. The other rule areas will have the reference placement and routing copied to them. Placement rule areas need the following settings configured in their properties:

- The options in the **Placement** tab should be configured to select the hierarchical sheet or component class that contains the channel's components.
- The options in the **Keepouts** tab should typically be unselected, unless there is a specific type of item that needs to be excluded from the rule area.
- The rule area's **layers** should be set based on which layers are considered part of the channel. An item will be copied from the reference channel to a target channel only if the item's layer is enabled in both the reference and target rule areas.

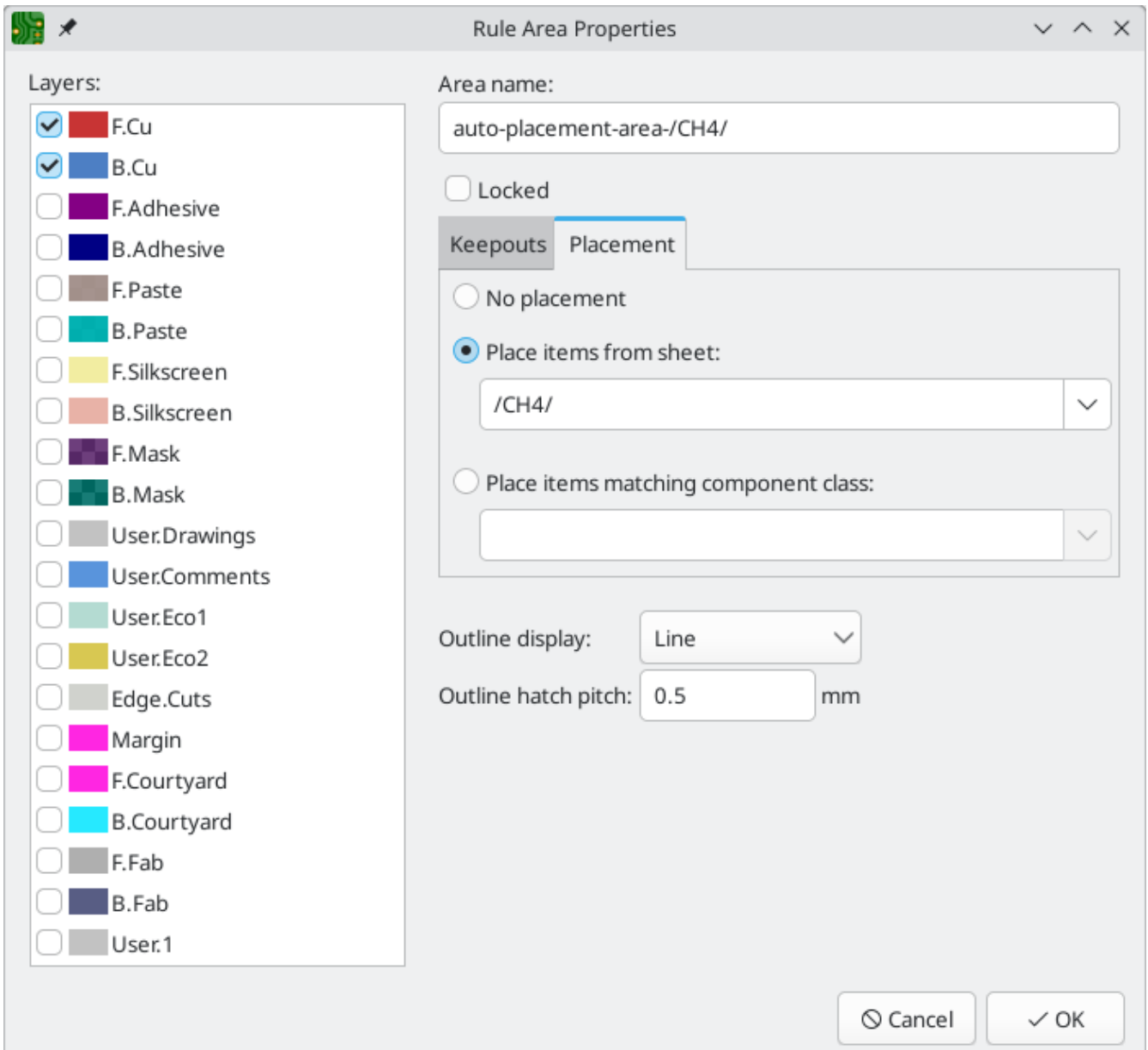

Placement rule areas can be manually created like any [rule area](#), or they can be automatically generated by selecting **Tools** → **Multi-Channel** → **Generate Placement Rule Areas...** This tool can draw basic placement rule areas for any of the hierarchical sheets or component classes in the design, depending on which you select.

NOTE

The tool allows you to generate a placement rule area for **any** sheet or component class, even if it is not intended to represent a channel in a multichannel design. It is your responsibility to select only the desired sheets or component classes.

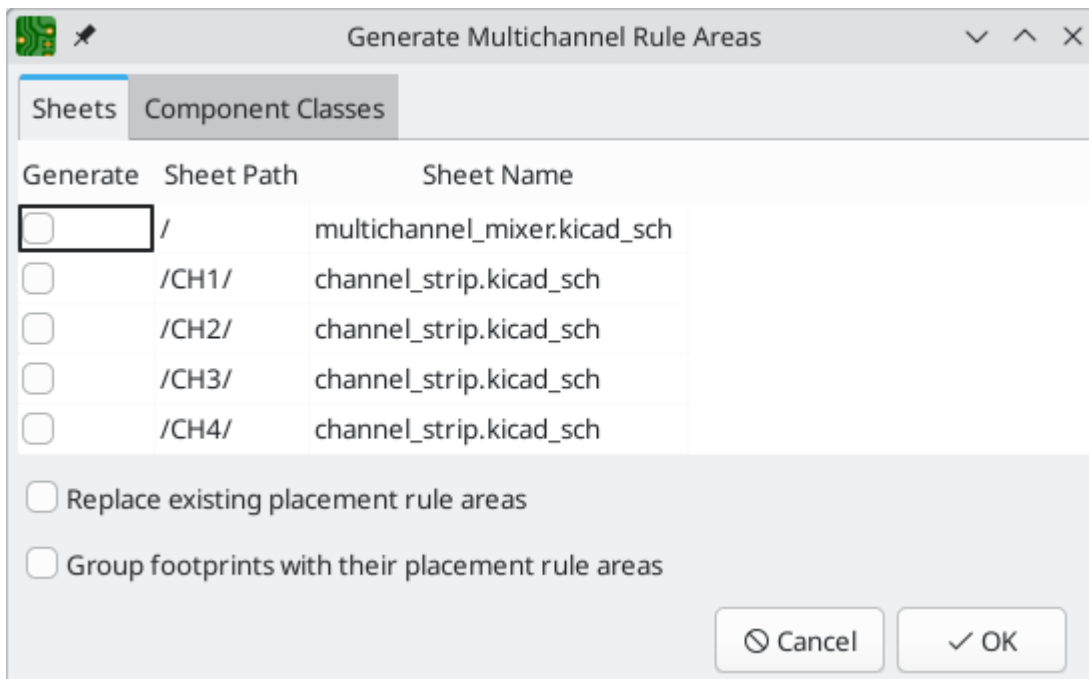

The tool has several options:

- **Replace existing placement rule areas:** if enabled, the newly generated rule area for each channel will replace any rule areas that already exist for that channel.
- **Group footprints with their placement rule areas:** if enabled, the newly generated rule area for each channel will be added to a [group](#) with all footprints associated with that rule area. This allows the target rule area and its associated items to be manipulated as a single entity.

Automatically generated rule areas are preconfigured as placement rule areas with the appropriate source hierarchical sheet or component class selected. Their layers are set to just the front and back copper layers. They are drawn as the minimum size rectangle that encloses their constituent footprints, without extra space for routing or other items. After generating a rule area, you may want to change the configured layers to ensure all desired items in the reference channel get copied to the target channels. You also may want to edit the shape of the rule area, although rule areas for target channels will have their shapes automatically adjusted to match the reference rule area.

NOTE

if generated rule areas are grouped with their footprints, you will need to enter the group (or ungroup the items) in order to edit the rule area.

Once you have created rule areas for each channel and completed placing footprints and routing for the reference channel, you can use the Repeat Layout tool to copy the reference channel's layout to the other channels. Run this tool using **Tools** → **Multi-Channel** → **Repeat Layout...**

If a rule area is selected when the tool is run, that rule area will be used as the reference rule area. If no rule area is selected, you will be prompted to select a rule area. When the reference rule area is determined, a dialog will appear.

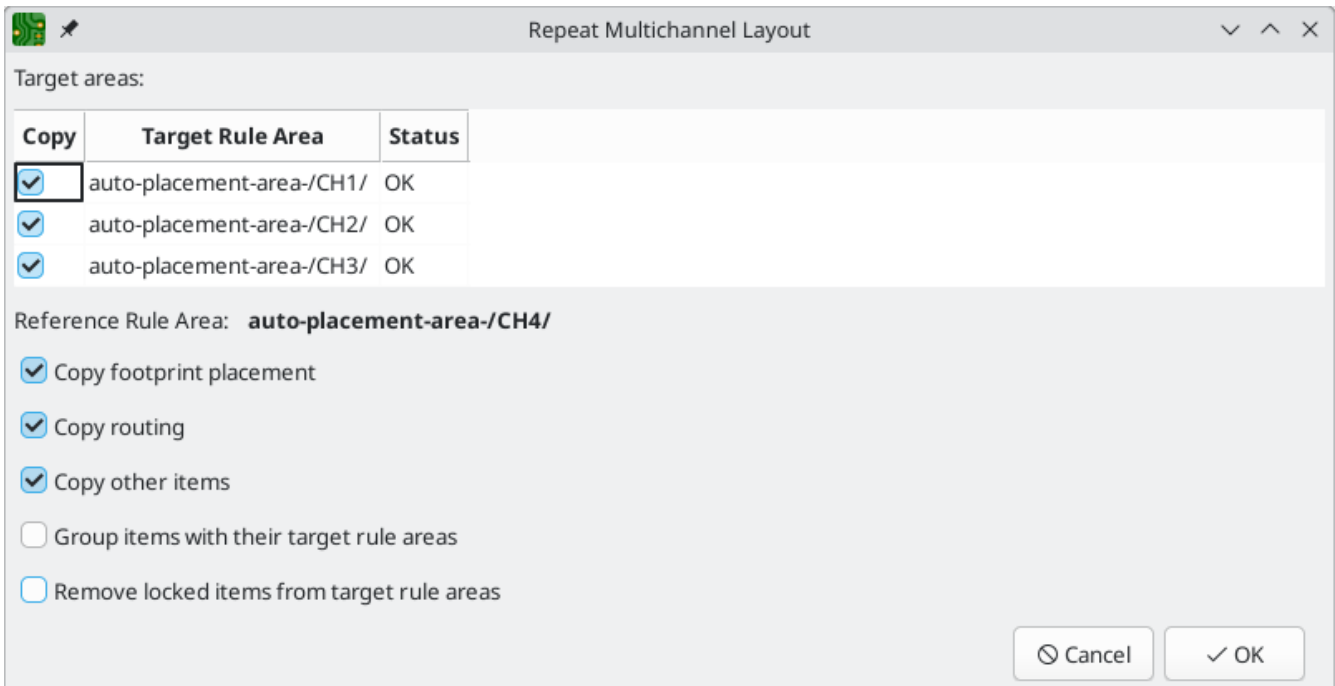

The table at the top of the dialog controls which target rule areas will receive the layout from the reference channel. Any target rule areas that are not selected will not be updated. The tool will only copy items to a target rule area if the target's status is listed as "OK". If the status is not "OK", the target channel's circuit topology cannot be matched to the reference channel; see the requirements for [how channels need to match in the schematic](#) for more information.

There are several options to control which items from the reference channel are copied to the selected target areas, and how those copied items are handled:

- **Copy footprint placement:** if enabled, the placement of footprints in the reference rule area will be replicated for footprints associated with the target rule area(s). Footprints are copied if they are enclosed by or intersect the reference rule area; they are not copied if they are fully outside. Footprints will only be copied if they are on a layer that is enabled in both the reference and target rule areas.
- **Copy routing:** if enabled, any tracks and vias in the reference rule area will be copied to the target rule area(s). Routing is copied if it is enclosed by or intersects the reference rule area; it is not copied if it is fully outside. Routing will only be copied if it is on a layer that is enabled in both the reference and target rule areas.
- **Copy other items:** if enabled, any other items (zones, graphic objects) fully enclosed by the reference rule area will be copied to the target rule area(s). Items are copied if they are fully enclosed by the reference rule area; they are not copied if they are partially or fully outside. This means, for example, that a large copper zone that intersects a reference channel will not be copied to the target channels. Items will only be replicated if they are on a layer that is enabled in both the reference and target rule areas.
- **Group items with their placement rule areas:** if enabled, the items copied to a target rule area will be added to a [group](#) with that rule area. This allows the target rule area and its associated items to be manipulated as a single entity.
- **Remove locked items from target rule areas:** if enabled, items associated with target rule areas will be updated even if they are [locked](#). If not enabled, locked items will not be updated to match the reference rule area.

After clicking **OK**, the layout from the reference channel will be applied to the target channels. When the repeat layout is completed, each channel can be individually edited like any other part of the board design.

Importing vector drawings

NOTE

KiCad文档的这一部分还没有写。我们感谢您耐心等待，因为我们的志愿文档编写小队撰写者组成的小团队正在努力更新和扩展文档，我们感谢您的耐心等待。

Using reference images

KiCad supports displaying reference images in the canvas. These are background images that you can use to help you lay out a board; they are purely for reference during the design process and are not included in any fabrication outputs.

To add a reference image, use the  button on the right toolbar and select the desired reference image file.

Once the image has been added to the canvas, you can scale it by dragging the editing canvas or open its properties dialog () and set the scale explicitly in the **Image** tab. Here you can also **Convert to Greyscale** if you wish.

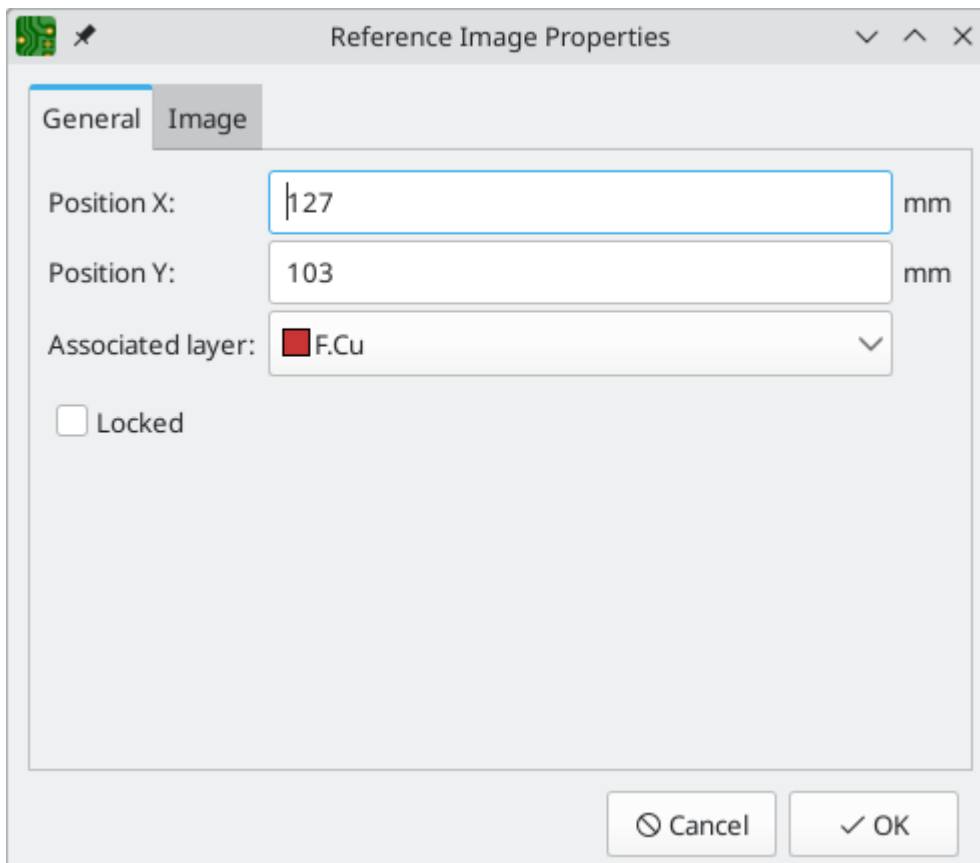

Reference images have an associated layer; they are shown and hidden along with this layer. The layer initially associated with a reference image is the layer that was active when the image was added. You can change the associated layer in the image's properties.

Another way to hide reference images is with the Appearance Manager. You can show or hide all reference images by toggling the visibility of **Image** objects in the **Objects** tab ( button). You can also adjust the opacity of reference images here.

向前和向后批注

Forward and back annotation are the processes for syncing schematic changes to the board and syncing board changes to the schematic, respectively.

从原理图更新 PCB（正向批注）

使用 "从原理图更新 PCB" 工具将设计信息从原理图编辑器同步到电路板编辑器。在原理图编辑器和电路板编辑器中都可以用 **工具** → **从原理图更新 PCB** (F8) 来访问该工具。你也可以使用电路板编辑器顶部工具栏上的  图标。这个过程通常被称为正向批注。

NOTE

从原理图更新 PCB 是将设计信息从原理图转移到 PCB 的首选方法。在旧版本的 KiCad 中，相应的过程是将网表从原理图编辑器中导出并导入到电路板编辑器中。现在已经没有必要使用网表文件了。

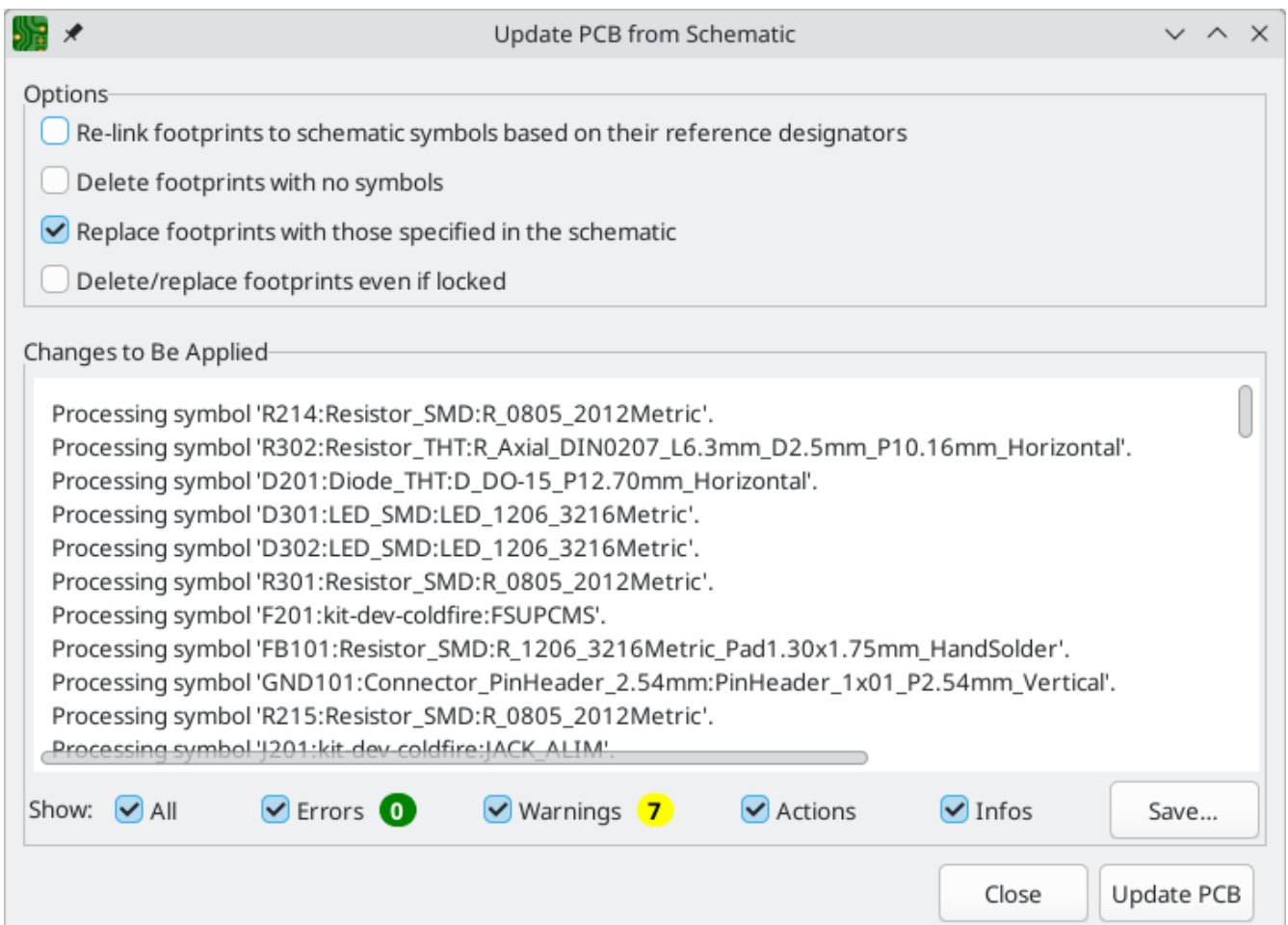

该工具将每个符号的封装添加到电路板上，并将更新的原理图信息传输到电路板上。尤其重要的是，电路板的网络连接也将更新以匹配原理图。

将对 PCB 进行的变更列在 *待应用的变更* 窗格中。在你点击 **更新 PCB** 按钮之前，PCB 不会被修改。

你可以使用窗口底部的复选框来显示或隐藏不同类型的信息。可以使用 **保存...** 按钮将变更的报告保存到文件中。

选项

该工具有几个选项来控制其行为。

Option	Description
<p>Re-link footprints to schematic symbols based on their reference designators</p>	<p>Footprints are normally linked to schematic symbols via a unique identifier created when the symbol is added to the schematic. A symbol's unique identifier cannot be changed.</p> <p>If checked, each footprint in the PCB will be re-linked to the symbol that has the same reference designator as the footprint.</p> <p>If unchecked, footprints and symbols will be linked by unique identifier as usual, rather than by reference designator. Each footprint's reference designator will be updated to match the reference designator of its linked symbol.</p> <p>This option should generally be left unchecked. It is useful for specific workflows that rely on changing the links between schematic symbols and footprints, such as refactoring a schematic for easier layout or replicating layout between identical channels of a design.</p>
<p>Delete footprints with no symbols</p>	<p>If checked, any footprint in the PCB without a corresponding symbol in the schematic will be deleted from the PCB. Footprints with the "Not in schematic" attribute will be unaffected.</p> <p>If unchecked, footprints without a corresponding symbol will not be deleted.</p>
<p>Replace footprints with those specified in the schematic</p>	<p>If checked, footprints in the PCB will be replaced with the footprint that is specified in the corresponding schematic symbol.</p> <p>If unchecked, footprints that are already in the PCB will not be changed, even if the schematic symbol is updated to specify a different footprint.</p>
<p>Delete/replace footprints even if locked</p>	<p>If checked, locking a footprint will not affect whether a footprint is deleted or replaced based on changes in the schematic.</p> <p>If unchecked, locked footprints will never be deleted or replaced even if they otherwise would be.</p>

从 PCB 更新原理图（反向批注）。

KiCad 的典型工作流程是在原理图中进行修改，然后使用 "从原理图更新 PCB" 工具将修改内容同步到电路板上。然而，相反的过程也是可行的：可以在电路板上进行设计修改，然后在原理图或电路板编辑器中使用 **工具 → 从 PCB 更新原理图** 同步到原理图上。这个过程通常被称为反向批注。

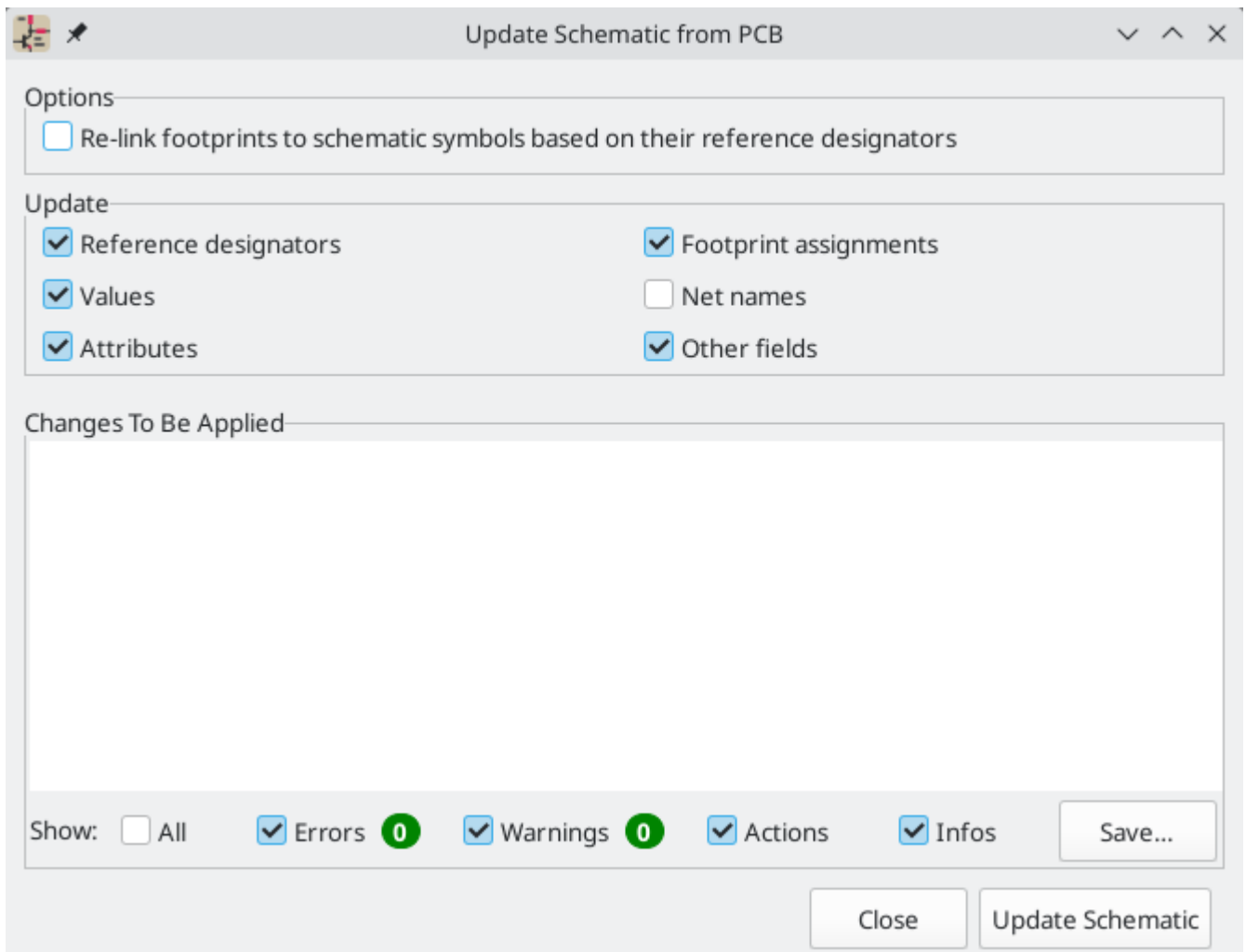

该工具将位号、值、封装分配和网络名称的变化从电路板同步到原理图。每种类型的变更都可以单独启用或禁用。

将对原理图进行的变更列在 *待应用的变更* 窗格中。在您点击 **更新原理图** 按钮之前，原理图不会被修改。

您可以使用窗口底部的复选框来显示或隐藏不同类型的信息。可以使用 **保存...** 按钮将变更的报告保存到文件中。

选项

该工具有几个选项来控制其行为。

Option	Description
Re-link footprints to schematic symbols based on their reference designators	<p>If checked, each footprint in the PCB will be re-linked to the symbol that has the same reference designator as the footprint. This option is incompatible with updating symbol reference designators.</p> <p>If unchecked, footprints and symbols will be linked by unique identifier as usual, rather than by reference designator.</p>
Reference designators	<p>If checked, symbol reference designators will be updated to match the reference designators of the linked footprints.</p> <p>If unchecked, symbol reference designators will not be updated.</p>
Values	<p>If checked, symbol values will be updated to match the values of the linked footprints.</p> <p>If unchecked, symbol values will not be updated.</p>
Footprint assignments	<p>If checked, footprint assignments will be updated for symbols which have had their footprints changed or replaced in the board.</p> <p>If unchecked, symbol footprint assignments will not be updated.</p>
Net names	<p>If checked, the schematic will be updated with any net name changes that have been made in the board. Net labels will be updated or added to the schematic as necessary to match the board.</p> <p>If unchecked, net names will not be updated in the schematic.</p>

NOTE

[按位置重新批注](#) 功能可以与反向批注位号结合使用，根据设计中的位置重新批注所有元件。

用 CMP 文件进行反向批注

通过从 PCB 编辑器导出 CMP 文件（**文件** → **导出** → **封装关联 (.cmp) 文件...**）并在原理图编辑器中导入（**文件** → **导入** → **封装分配...**），也可以将选择的变化从 PCB 上同步到原理图。

NOTE

这种方法只能同步对封装分配和封装字段的修改。建议使用 "从 PCB 更新原理图" 工具来代替。

按位置重新批注

The Geographical Reannotation tool lets you automatically set the reference designators of footprints based on their physical location on the board.

To run the Geographical Reannotation tool, use **Tools** → **Geographical Reannotate....** This opens the geographical reannotation dialog with options for how to perform the reannotation.

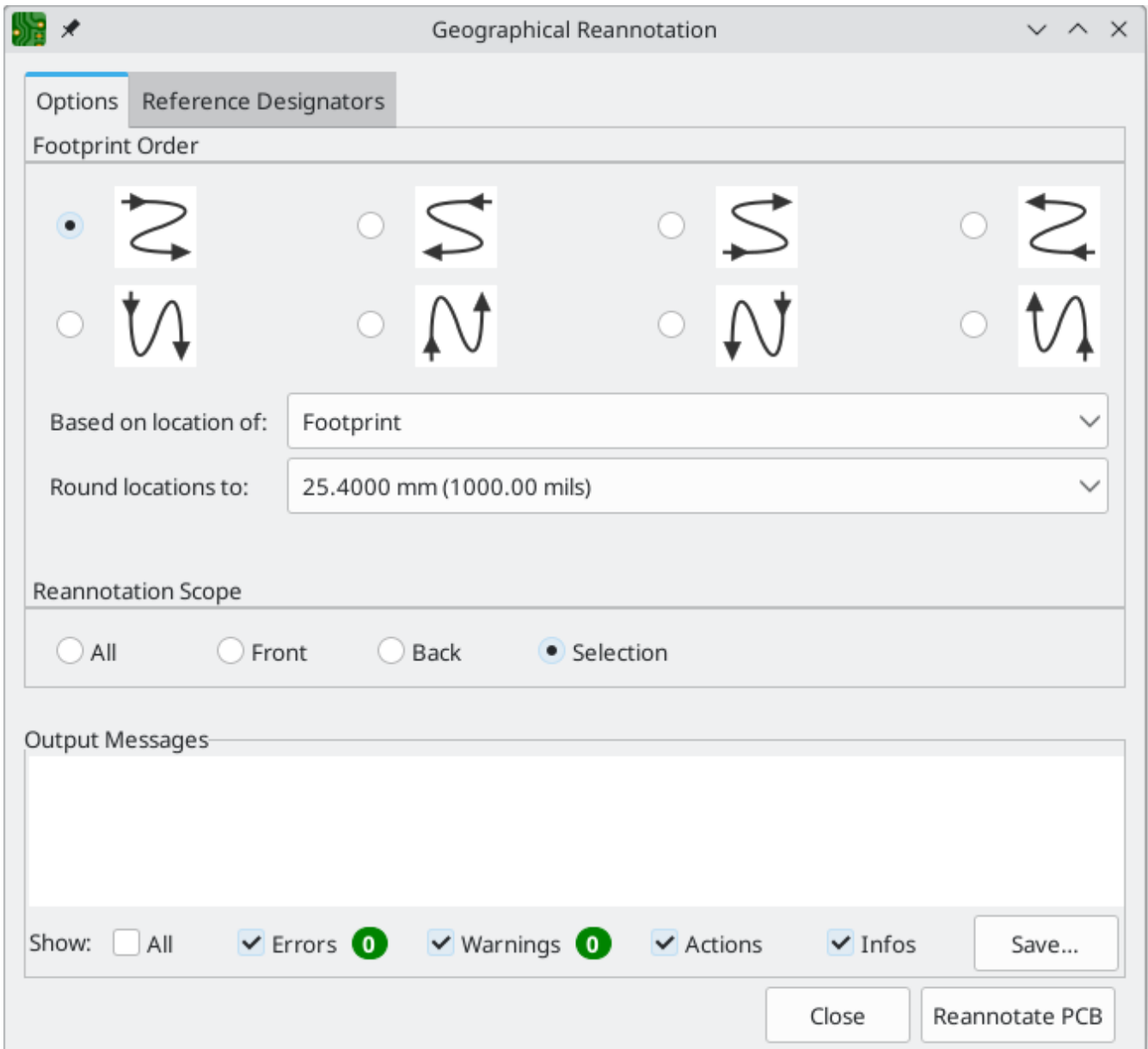

The **Options** tab contains settings for how footprint locations affect reannotation. The arrow diagrams indicate which geographical ordering to use when reannotating. You can reannotate from left-to-right, right-to-left, top-to-bottom, or bottom-to-top, and you can select whether to use a column-major order (go through all footprints in the same column before moving to the next column) or row-major order (go through all footprints in the same row before moving to the next row).

Geographical reannotation can either use the location of the footprint itself or the location of the footprint's reference designator. You can also select how much to round footprint locations before determining which footprints are at the same X or Y position. Rounding to a finer coordinate resolution will result in fewer footprints considered to be in the same row or column.

Finally, you can select which footprints to reannotate. You can reannotate all footprints on the board, all footprints on the front or back of the board, or all footprints in your selection.

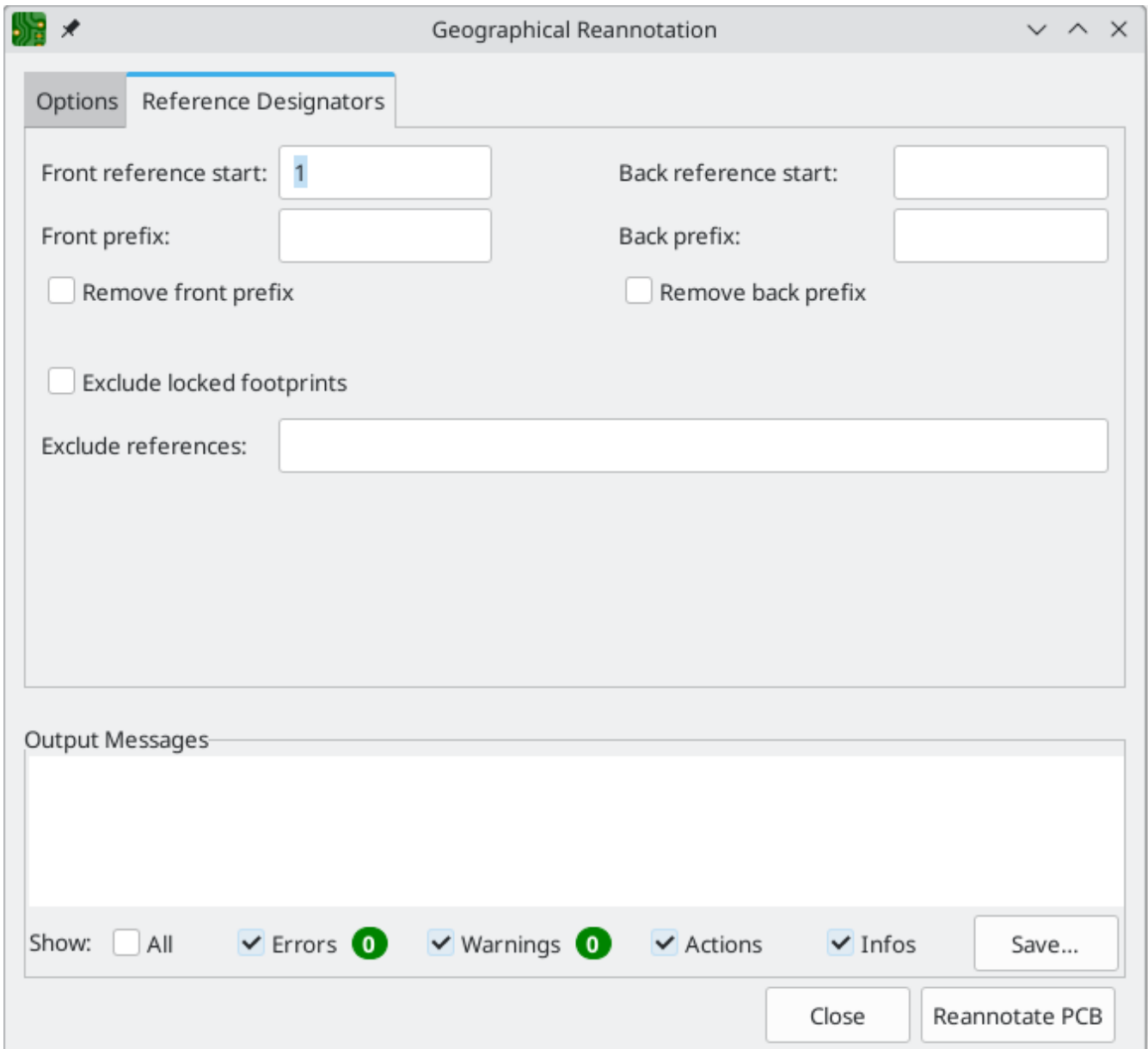

The **Reference Designators** tab contains options for how to allocate new reference designators. There are separate settings for footprints on the front and back of the board.

Reference start controls the number for the first new reference designator on each side of the board. If no start value is given for the back of the board, back side footprints will be annotated starting at one higher than the last front side reference designator.

Prefix specifies a prefix string to insert at the beginning of each newly assigned reference designator. This prefix will be inserted before any prefix that is already present. If the **remove prefix** option is selected, footprints with the specified prefix will instead have that prefix removed instead of added. Footprints without that prefix will not have any prefix added or removed.

If **exclude locked footprints** is checked, locked footprints will not be reannotated. You can also avoid reannotating specific footprints by entering their reference designators as a comma-separated list in the **exclude references** box.

When you click the **Reannotate PCB** button, footprints will be reannotated according to the selected settings.

NOTE

The Geographical Reannotation tool updates reference designators in the board, but not in the schematic. After geographically reannotating the board, be sure to sync the updated reference designators to the schematic by running the [Update Schematic from PCB](#) tool with the **re-link footprints to schematic symbols based on their reference designators** option disabled. If the schematic is not updated, reference designators in the board will not match those in the schematic.

检查电路板

设计规则检查

设计规则检查器用于验证 PCB 是否符合“电路板设置”对话框中建立的所有要求，以及所有焊盘是否按照网表或原理图连接。KiCad 可以在布线时自动防止一些违反设计规则的行为，但许多其他的行为是无法自动防止的。这意味着在为 PCB 生成制造文件之前，必须使用设计规则检查器。

要使用设计规则检查器，请点击顶部工具栏的  图标，或从 **检查** 菜单中选择 **设计规则检查器**。



DRC 控制窗口的顶部部分包含一些控制设计规则检查器的选项：

Refill all zones before performing DRC: when enabled, zones will be refilled every time the design rule checker is run. Disabling this option may result in incorrect DRC results if zones have not been refilled manually.

Report all errors for each track: when enabled, all clearance errors will be reported for each track segment. When disabled, only the first error will be reported. Enabling this option will result in the design rule checker running more slowly.

Test for parity between PCB and schematic: when enabled, the design rule checker will test for differences between the schematic and PCB in addition to testing the PCB design rules. This option has no effect when running the PCB editor in standalone mode.

After running DRC, any violations will be shown in the center part of the DRC window. Rule violations, unconnected items, and differences between the schematic and the PCB are shown in three different tabs. A list of the ignored tests is shown in the fourth tab. A report file in plain text format can be created after running DRC using the **Save...** button.

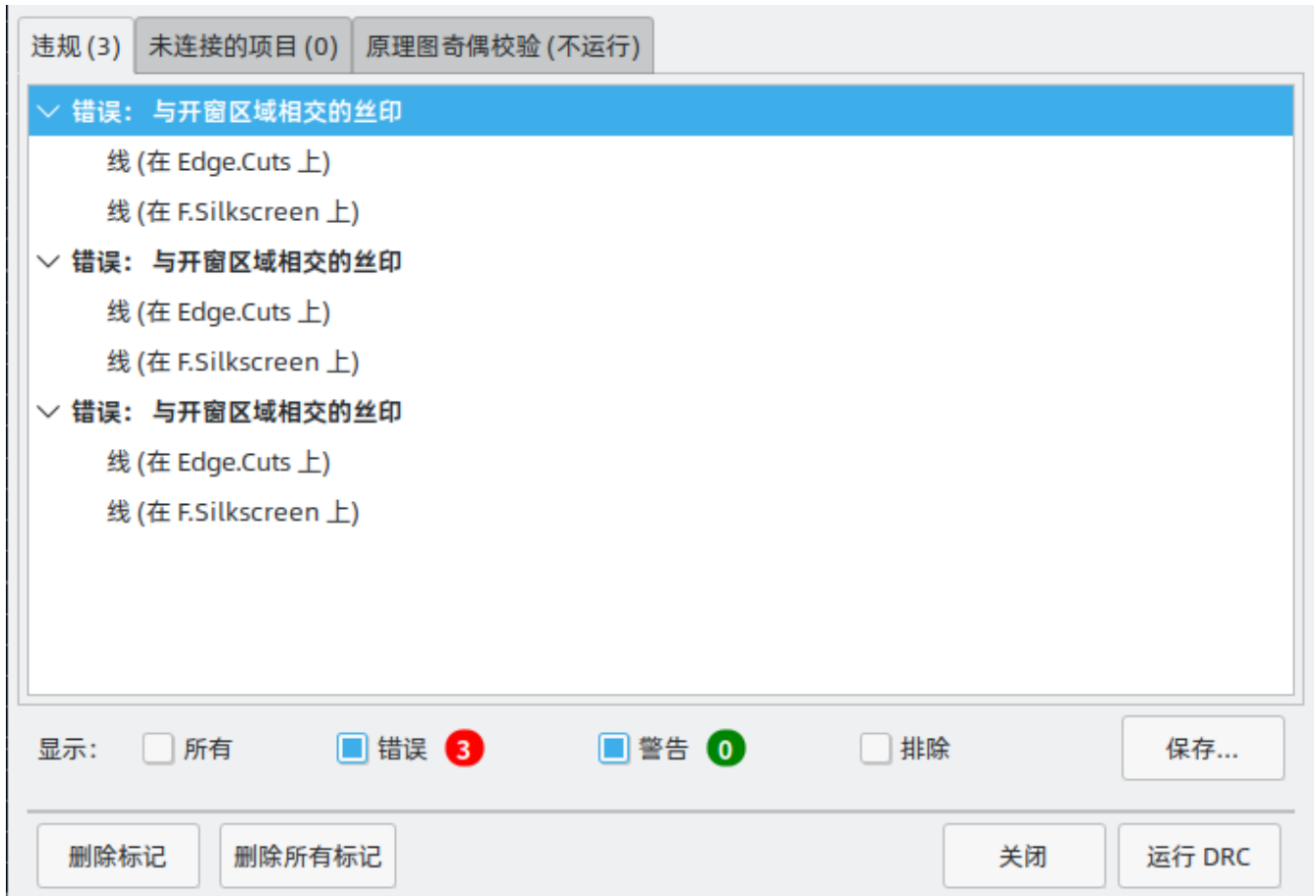

每个违规行为都涉及 PCB 上的一个或多个对象。在违规列表中，涉及的对象列在违规行为下面。点击列表中的违规行为将移动“PCB 编辑器”的视图，使受影响的区域居中。点击违规所涉及的对象之一将高亮显示该对象。

Certain types of violations have contextual actions in the context menu. For example, clearance violations have an action to run the [clearance resolution tool](#) on the violating items, while custom rule violations have an action to run the [constraint resolution tool](#). For board vs. library footprint mismatch violations, there is an action to run the [Compare Footprint with Library](#) tool. These actions can help to quickly identify the reason for a particular violation.

The numbers at the bottom of the window show the number of errors, warnings, and exclusions. Each type of violation can be filtered from the list using the respective checkboxes. Clicking **Delete Marker** will clear the selected violation until DRC is run again, while clicking **Delete All Markers** will clear all violations until the next DRC run.

可以在对话框中右键单击违规行为，以忽略它们或改变其严重程度：

- **Exclude this violation:** ignores this particular violation, but does not affect any other violations. You can un-exclude a violation by right clicking the excluded violation and selecting **Remove exclusion for**

this violation.

- **Exclude with comment...:** the same as **Exclude this violation**, but prompts for a comment explaining the reason for the exclusion. When excluded violations are unhidden (using the **Exclusions** checkbox), exclusion comments are shown with the corresponding excluded violation. To edit an existing exclusion comment or add a comment to an existing exclusion, right click an excluded violation and select **Edit exclusion comment...**
- **Exclude all violations of rule:** the same as **Exclude this violation**, but excludes *all* violations caused by the same [custom DRC rule](#). This action only appears in the context menu for violations caused by custom design rules. If you right click on a custom design rule violation that is already excluded, you can instead **Remove all exclusions for violations of rule**.
- **Change severity:** changes a type of violation from warning to error, or error to warning. This affects all violations of a given type.
- **Ignore all:** ignores all violations of a given type. This test will now appear in the **Ignored Tests** tab rather than the **Violations** tab. You can un-ignore the test again by right clicking the test in the **Ignored Tests** tab, or in the [Violation Severity panel](#) in Board Setup.
- **Edit violation severities...:** opens the [Violation Severity panel](#) in Board Setup, for editing the severities of all DRC violation types.

Excluded and ignored violations are remembered between runs of the design rule checker. Excluded violations are hidden unless the **Exclusions** checkbox is enabled. Ignored violations are not shown, but there is a list of ignored tests in the **Ignored Tests** tab.

间隙和约束解析

间隙和约束解析工具允许你检查哪些间隙和设计约束规则应用于选定的项目。当设计具有复杂设计规则的 PCB 时，这些工具可以提供帮助，因为在这种情况下并不总是清楚哪些规则适用于哪些对象。

要检查两个对象之间适用的间隙规则，选择这两个对象并从 **检查** 菜单中选择 **间隙解析**。间隙报告对话框将显示每个铜层上的对象之间所需的间隙，以及产生该间隙的设计规则。



要检查适用于单一对象的设计约束，选择它并从 **检查** 菜单中选择 **约束解析**。约束报告对话框将显示适用于该对象的所有约束。



DRC configuration

The severity of each DRC check can be configured in the **Violation Severity** section of the [Board Setup dialog](#). Each rule may be set to create an error marker, a warning marker, or no marker (ignored).

NOTE

在设计规则检查器中可能会忽略个别规则违规。在违规程度部分中将规则设置为忽略将完全禁用相应的设计规则检查。请谨慎使用此设置。



List of DRC checks

The table below lists the design rules that KiCad checks and the default violation severity for each check. All severities are configurable. Some design are only available through [custom design rules](#).

Electrical DRC checks

These DRC checks look for gross electrical issues on the board such as shorts and clearance violations.

Violation	Description	Default Severity
Items shorting two nets	This violation occurs when copper items on different nets collide with each other. If this is intentional, consider using a net tie .	Error
Tracks crossing	This violation occurs when tracks with different nets cross each other.	Error

Violation	Description	Default Severity
Clearance violation	<p>This violation occurs when the distance between two copper items with different nets is smaller than the configured clearance for those nets. The allowed clearance between two items can come from the board-level minimum clearance, the net class settings for each net, or from custom rules. To see detailed information about the configured and actual clearances between two selected items, run the clearance resolution tool, which is available by right clicking the violation in the DRC window. The minimum clearance path is highlighted in the editing canvas when a clearance violation is selected in the DRC window.</p> <p>This violation is also reported when the distance between two items is smaller than the configured physical clearance for those two items. Physical clearance constraints are not configured by default; see the custom rule documentation for how to configure physical clearance.</p>	Error
Creepage violation	<p>This violation occurs when the creepage distance between two copper items with different nets is smaller than the configured creepage for those nets. Creepage paths are highlighted in the editing canvas when a creepage violation is selected in the DRC window.</p> <p>Creepage distances can be configured using a creepage constraint in custom rules.</p>	Error
Via is not connected or is connected on only one layer	<p>This violation occurs when a via is connected to copper objects on only one layer or is not connected to anything. As vias are intended to connect copper objects on different layers, this may indicate that an intended connection is missing.</p>	Warning
Track has unconnected end	<p>This violation occurs when the end of a track segment is not connected to another copper object, such as another track segment, a via or pad, or a zone or copper graphical shape.</p>	Warning

Violation	Description	Default Severity
Board edge clearance violation	<p>This violation occurs when the distance between a copper object and the board edge is smaller than the configured copper to edge clearance for those items. For the purposes of this check, oval holes (which are routed rather than drilled) are counted as board edges in addition to any graphic items on the Edge.Cuts layer.</p> <p>The allowed edge clearance between two items can come from the board-level minimum copper to edge clearance or from custom rules. A negative edge clearance allows objects to overlap with the board edge. To see detailed information about the configured and actual edge clearances between two selected items, run the clearance resolution tool.</p>	Error
Hole clearance violation	<p>This violation occurs when the distance between a hole (pad or via) and another copper object (pad, track, via, or zone) is smaller than the configured copper to hole clearance for those objects. Objects are only considered in this check if they have layers in common. The allowed hole clearance between two items can come from the board-level minimum copper to hole clearance or from custom rules. To see detailed information about the configured and actual hole clearances between two selected items, run the clearance resolution tool.</p> <p>This violation is also reported when the distance between a hole and another object is smaller than the configured physical hole clearance for those two items. Physical hole clearance constraints are not configured by default; see the custom rule documentation for how to configure physical hole clearance.</p>	Error

Violation	Description	Default Severity
Track width	<p>This violation occurs when the width of a track is outside of the configured range. The allowed width for a track can come from the board-level minimum track width or from custom rules.</p> <p>Note that an optimal track width can be configured for each net class in the net class settings, which sets a track width for the interactive router to use, but it does not set a minimum and maximum track width. No DRC violations will be reported for net class track width settings unless a minimum and/or maximum are configured using custom rules.</p> <p>To see detailed information about the configured track width for a particular track, run the constraints resolution tool.</p>	Error
Track angle	<p>This violation occurs when the angle between two connected track segments is outside the configured range.</p> <p>Minimum and/or maximum allowable track angles can be configured using a <code>track_angle</code> constraint in custom rules.</p>	Error
Track segment length	<p>This violation occurs when the length of a track segment is outside the configured range.</p> <p>Minimum and/or maximum allowable track segment lengths can be configured using a <code>track_segment_length</code> constraint in custom rules.</p>	Error
Annular width	<p>This violation occurs when a pad or via's annular width is outside of the configured range.</p> <p>Board-level minimum annular width can be configured in board setup constraints. Board-level maximum width, as well as more specific rules, can be configured using custom rules.</p>	Error

Violation	Description	Default Severity
Courtyards overlap	This violation occurs when a footprint's courtyard overlaps with another footprint's courtyard. A nonzero clearance between two courtyards can be configured using a <code>courtyard_clearance</code> constraint in custom rules . A negative courtyard clearance allows courtyards to intersect.	Error
Footprint has no courtyard defined	This violation occurs when a footprint does not contain any graphic shapes on its <code>F.Courtyard</code> or <code>B.Courtyard</code> layers.	Ignore
Footprint has malformed courtyard	This violation occurs when a footprint has a courtyard containing non-closed shapes. Courtyards may contain multiple unconnected shapes without being considered malformed, as long as each shape is individually closed.	Error
Board has malformed outline	This violation occurs when the shapes on the <code>Edge.Cuts</code> layer do not form a valid board outline. Valid board outlines consist of closed shapes that do not self-intersect. Board outlines may contain multiple unconnected shapes without being considered malformed, as long as each shape is individually closed and does not intersect with itself or other shapes. This check also reports very small (nanometer-scale) graphic shapes on the <code>Edge.Cuts</code> layer, which are difficult to find visually but may cause issues in other tools.	Error
Copper sliver	This violation occurs when small, wedge-shaped protrusions of copper are detected. These slivers can cause manufacturing, reliability, or electrical issues.	Warning
Solder mask aperture bridges items with different nets	This violation occurs when a single opening in the soldermask exposes multiple copper items with different nets. This can result in solder shorting the two copper items during assembly.	Error
Copper connection too narrow	This violation occurs when a copper connection necks down to a width that is narrower than the configured minimum connection width. The minimum connection width setting can come from the board-level minimum connection width or can be configured with more granularity using custom rules .	Warning

Schematic parity DRC checks

Violation	Description	Default Severity
Duplicate footprints	This violation occurs when the board contains multiple footprints with the same reference designator are in the board. It is not reported if the footprints do not correspond to schematic symbols, however (if the footprints only exist in the board).	Warning
Missing footprint	This violation occurs when a footprint is not in the board but is expected based on a corresponding symbol in the schematic.	Warning
Extra footprint	This violation occurs when a footprint is in the board without a corresponding symbol in the schematic.	Warning
Footprint attributes don't match symbol	This violation occurs when a footprint's Value field, "DNP" attribute, or "Exclude from BOM" attribute are set differently than the corresponding field/attribute in the matching schematic symbol. It also occurs when a symbol's assigned footprint is different than the actual footprint in the board. Typically this is fixed by performing an Update PCB from Schematic or Update Schematic from PCB action to sync the fields and attributes, depending on whether the symbol or footprint, respectively, is correct.	Warning
Footprint doesn't match symbol's footprint filters	This violation occurs when a footprint does not match footprint filters in the corresponding symbol. If the symbol doesn't have any footprint filters, no violation occurs.	Ignore
Pad net doesn't match schematic	This violation occurs when a net does not match between a footprint pad and the corresponding symbol pin. This can be because the symbol pin's net is different than the footprint pad's net, because the footprint pad does not have a corresponding symbol pin, or because the symbol pin does not have a corresponding footprint pad.	Warning
Missing connection between items	This violation occurs when two copper objects with the same net are not connected on the board.	Error

Signal integrity DRC checks

These DRC checks look for signal integrity issues in the board.

Violation	Description	Default Severity
Track length out of range	<p>This violation occurs when a track in a differential pair is too long or too short compared to the configured minimum and maximum length for that track. The allowable track length for different tracks can be configured using the <code>length</code> constraint in custom rules.</p>	Error
Skew between tracks out of range	<p>This violation occurs when the difference between the length of a track and the maximum length of all tracks being considered is longer than the configured maximum skew for that set of tracks. For calculating the skew of a differential pair (two tracks), the skew therefore is calculated as the length difference between tracks.</p> <p>The allowable maximum skew for a set of tracks, as well as which tracks the rule applies to, can be configured using the <code>skew</code> constraint in custom rules.</p>	Error
Too many or too few vias on a connection	<p>This violation occurs when the number of vias assigned to a net is too low or too high compared to the configured minimum and maximum for that net. The allowable via count for different nets can be configured using the <code>via_count</code> constraint in custom rules.</p>	Error
Differential pair gap out of range	<p>This violation occurs when the gap between the two tracks in a differential pair is too small or too large compared to the configured minimum and maximum for that differential pair. The gap is only checked on coupled (i.e. parallel) portions of the differential pair.</p> <p>The minimum and maximum allowable gap for a differential pair can be configured using the <code>diff_pair_gap</code> constraint in custom rules.</p> <p>Note that an optimal differential pair gap can be configured for each net class in the net class settings, which sets a gap for the differential pair router to use, but it does not set a minimum and maximum gap. No DRC violations will be reported unless a minimum and/or maximum are configured using custom rules.</p>	Error

Violation	Description	Default Severity
Silkscreen overlap	<p>This violation occurs when a silkscreen object intersects another silkscreen object, which may affect readability. This check does not apply to silkscreen objects within the same footprint.</p> <p>The allowable distance between silkscreen objects can also be set to a nonzero number to enforce a silk to silk clearance using the board-level silkscreen minimum item clearance or using custom rules. A negative silkscreen clearance allows silkscreen to intersect other objects.</p>	Warning
Silkscreen clipped by solder mask	<p>This violation occurs when a silkscreen object intersects a solder mask opening. This may result in silkscreen printed on bare copper or substrate. Board manufacturers may also discard any silkscreen that does not have solder mask underneath. Such outcomes could affect board assembly as well as silkscreen durability and readability.</p>	Warning
Silkscreen clipped by board edge	<p>This violation occurs when a silkscreen object intersects a board edge, meaning that part of the silkscreen is outside of the board area.</p> <p>The allowable distance between silkscreen and the board edge can also be set to a nonzero number to enforce a clearance to the board edge using the board-level silkscreen minimum item clearance or using custom rules. A negative silkscreen clearance allows silkscreen to intersect other objects.</p>	Warning
Text height out of range	<p>This violation occurs when a text object's text height is outside of the configured range.</p> <p>Board-level minimum text height can be configured in board setup constraints. Board-level maximum height, as well as more specific rules, can be configured using custom rules.</p>	Warning

Miscellaneous DRC checks

These DRC checks look for other miscellaneous issues in the board.

Violation	Description	Default Severity
Items not allowed	This violation occurs when objects are placed in a location where they are not allowed. This can be due to a rule area with a keep out rule for the object's type or due to a <code>disallow</code> custom rule constraint.	Error
Copper zones intersect	This violation occurs when copper zones with different nets collide with each other, shorting the two nets.	Error
Isolated copper fill	This violation occurs when part of a copper fill is not connected to any other copper items with the same net. This is also referred to as an island.	Warning
Footprint is not valid	This violation occurs when a footprint's net tie group contains a pad that doesn't exist in the footprint, or when a pad is in more than one net tie group.	Error

Violation	Description	Default Severity
Padstack is questionable	<p>This violation occurs when a footprint pad has unusual settings that are probably a mistake. The settings that are checked are:</p> <ul style="list-style-type: none"> • Plated through holes without copper pads on any layer • Pads with inappropriate properties, such as through hole pads with the BGA property • Connector pads with solder paste • SMD pads with copper on both sides • SMD pads with copper on the opposite side from the corresponding solder mask opening or solder paste • SMD pads with no copper on outer layers • Plated through hole pads with no copper annulus around the hole • Plated through hole pads with hole partially or fully outside of the copper • Potential issues with solder mask clearance • Pads with negative local electrical clearance • Pads with an excessively large corner chamfer/radius 	Warning
PTH inside courtyard	This violation occurs if a footprint's plated through hole pad is within the courtyard of another footprint.	Warning
NPTH inside courtyard	This violation occurs if a footprint's nonplated through hole pad is within the courtyard of another footprint.	Warning
Item on a disabled copper layer	This violation occurs if an item, for example a pad or via, is on a copper layer that does not exist in the board stackup .	Error
Unresolved text variable	This violation occurs when a text variable in the board design or drawing sheet does not resolve (there is no defined value for the variable).	Error

Violation	Description	Default Severity
Footprint doesn't match copy in library	<p>This violation occurs when a footprint in the board is different than the library version of the footprint.</p> <p>You can compare between the board and library versions of the footprint using the Compare Footprint with Library tool, which is available by right clicking the violation in the DRC window. If desired, you can update the board footprint to match the library footprint.</p>	Warning
Through hole pad has no hole	This violation occurs when a through hole footprint pad does not have a hole.	Error

User-definable DRC violations

You can manually trigger board DRC warnings or errors using special [text variables](#). These items will appear as errors or warnings when DRC runs. This can be useful to flag items for later followup or review.

To cause a DRC violation, use the text variable `#{DRC_ERROR <violation name>}` or `#{DRC_WARNING <violation name>}` depending on whether an error or warning is desired. You can place this in a text item or text box on any board layer. When DRC runs, this will generate a DRC violation with the given violation name. These text variables resolve to an empty string in the board, and any text after the braces is included in the DRC violation's description. The text variable must be placed at the start of the text object in order to trigger a violation.

For example, a text item containing `#{DRC_ERROR TODO}Length match tracks` will appear in the board as just the text "Length match tracks", and will generate an ERC error named "TODO" with "Length matches tracks" in the description.

DRC report file

An DRC report file can be generated and saved by clicking the **Save...** button in the DRC dialog. The file extension for DRC report files is `.rpt`. An example DRC report file is given below.

```
** Drc report for pic_programmer.kicad_pcb **
** Created on 2024-11-02T15:54:52-0400 **

** Found 4 DRC violations **
[starved_thermal]: Thermal relief connection to zone incomplete (layer bottom_layer; 1
spokes connected to isolated island)
  Local override; error
  @(223.5200 mm, 138.4300 mm): Zone [GND] on bottom_layer
  @(175.2600 mm, 68.5800 mm): PTH pad 8 [GND] of P3
[starved_thermal]: Thermal relief connection to zone incomplete (layer bottom_layer; zone
min spoke count 2; actual 1)
  Local override; error
  @(223.5200 mm, 138.4300 mm): Zone [GND] on bottom_layer
  @(207.8990 mm, 118.1100 mm): PTH pad 5 [GND] of U5
[starved_thermal]: Thermal relief connection to zone incomplete (layer bottom_layer; 1
spokes connected to isolated island)
  Local override; error
  @(223.5200 mm, 138.4300 mm): Zone [GND] on bottom_layer
  @(125.7300 mm, 111.7600 mm): PTH pad 10 [GND] of U2
[starved_thermal]: Thermal relief connection to zone incomplete (layer bottom_layer; zone
min spoke count 2; actual 1)
  Local override; error
  @(223.5200 mm, 138.4300 mm): Zone [GND] on bottom_layer
  @(118.1100 mm, 111.7600 mm): PTH pad 13 [GND] of U2

** Found 0 unconnected pads **

** Found 0 Footprint errors **

** End of Report **
```

Board Statistics

The Board Statistics dialog shows a summary of the board's contents, including the number of components, pads and vias; each by their own types as well as the overall board size.

Board Statistics
^ X

General
Drill Holes

Components	Front Side	Back Side	Total	Pads	
THT:	5	0	5	Through hole:	149
SMD:	151	76	227	SMD:	996
Unspecified:	18	18	36	Connector:	0
Total:	174	94	268	NPTH:	4
				Total:	1149

Board Size		Vias	
Width:	80.0000 mm	Through vias:	416
Height:	49.0000 mm	Blind/buried:	0
Area:	3906.2472 mm ²	Micro vias:	0
		Total:	416

Subtract holes from board area
 Exclude footprints with no pads

Generate Report File...
Close

测量工具

测量工具允许你在 PCB 上的各点之间进行距离和角度测量。要激活该工具，请点击右侧工具栏的  图标，或使用快捷键 **Ctrl + Shift + M**。一旦该工具被激活，点击一次以设置测量起点，然后再点击一次以完成测量。

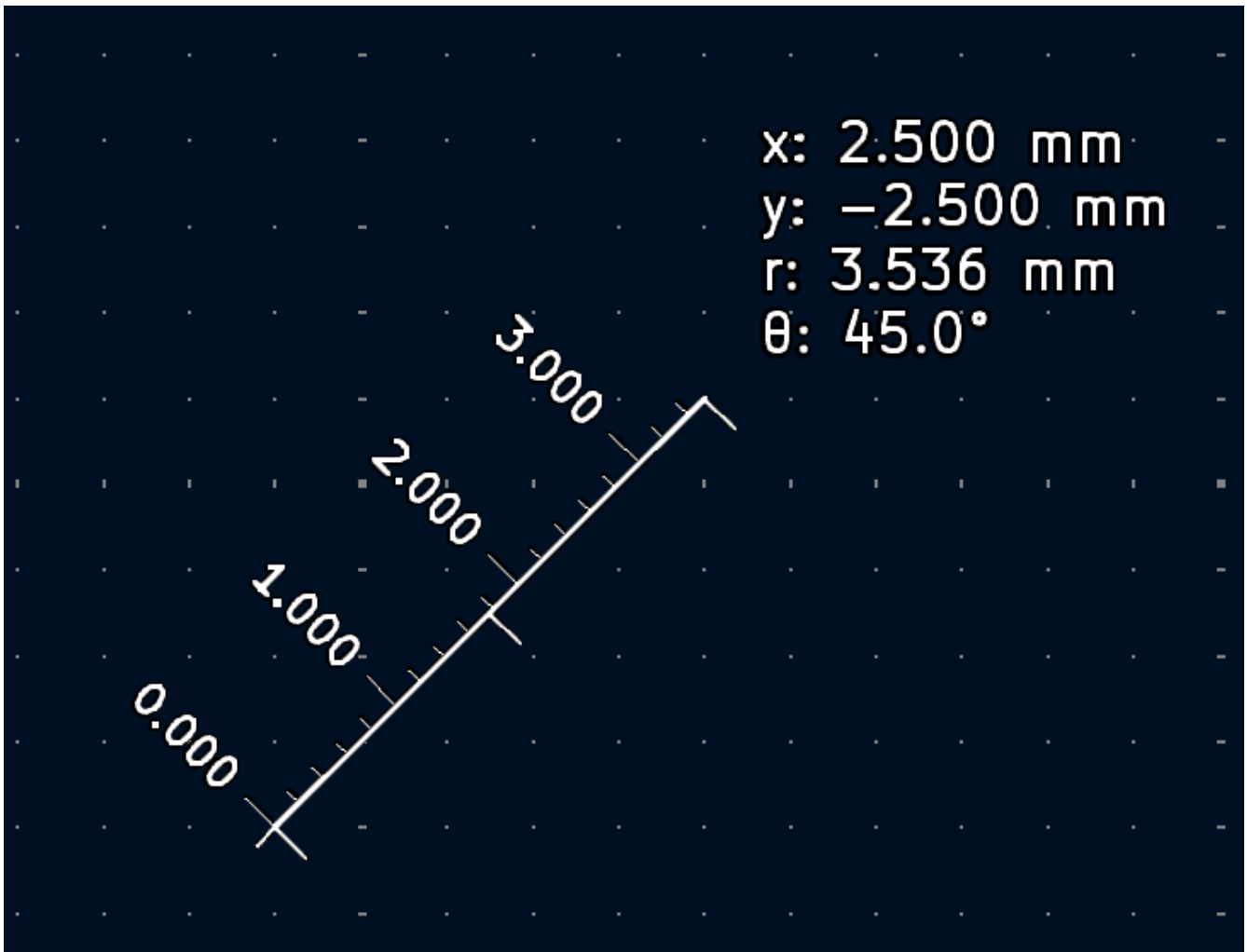

The tool displays the total (radial) distance between the points, the distance in X and Y directions, and the measured angle from horizontal. In other words, both the Cartesian and radial (polar) distances are displayed.

NOTE

测量工具用于不需要永久显示的快速测量。您所做的任何测量都将仅在该工具处于活动状态时显示。要创建将显示在打印输出和打印中的永久性尺寸标注，请使用尺寸标注工具。

查找工具

查找工具在 PCB 中搜索文本，包括位号、封装字段和图形文本。当该工具找到一个匹配的文本时，画布会被放大，并将其置于匹配文本的中心位置，同时文本被高亮显示。使用顶部工具栏中的 (A) 按钮启动该工具。

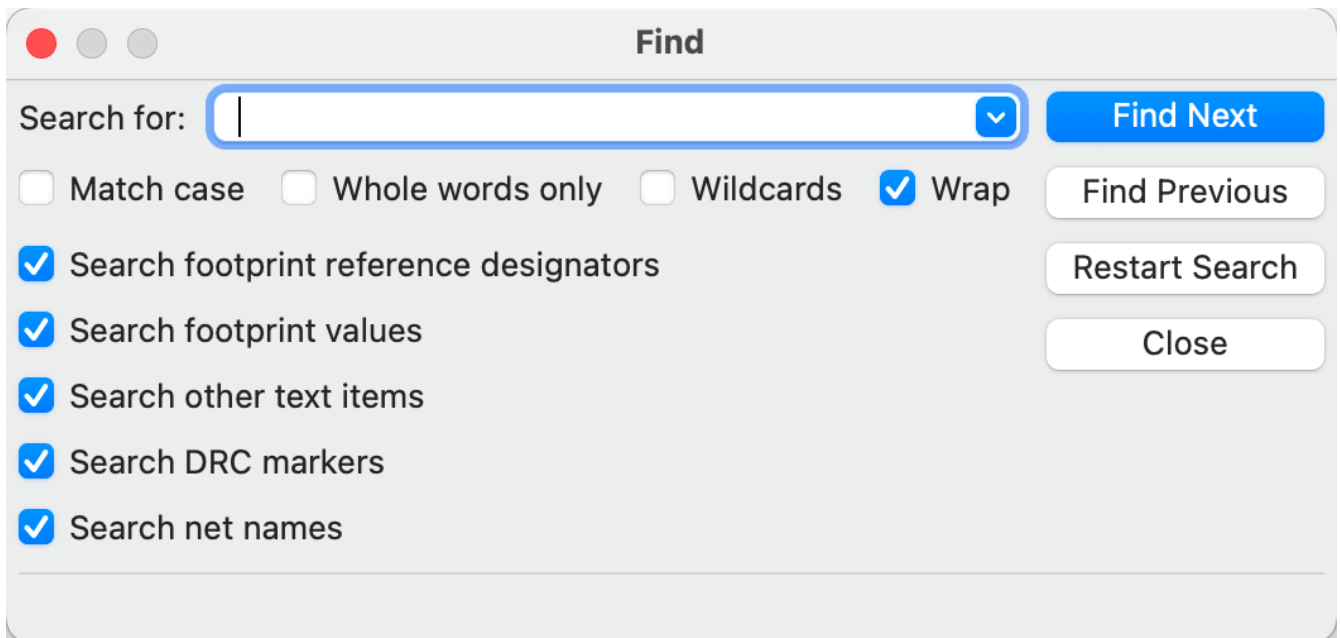

查找工具有几个选项：

Match case: Selects whether the search is case-sensitive.

Whole words only: When selected, the search will only match the search term with complete words in the PCB. When unselected, the search will match if the search term is part of a larger word in the PCB.

Wildcards: When selected, wildcards can be used in the search terms. `?` matches any single character, and `*` matches any number of characters. Note that when this option is selected, partial matches are not returned: searching for `abc*` will match the string `abcd`, but searching for `abc` will not.

Wrap: When selected, search results will return to the first hit after reaching the last hit.

Search footprint reference designators: Selects whether the search should apply to footprint reference designators.

Search footprint values: Selects whether the search should apply to footprint value fields.

Search other text items: Selects whether the search should apply to other text items, including graphical text and footprint fields other than value and reference.

Search DRC markers: Selects whether the search should apply to the violation descriptions of DRC markers shown on the board.

Search net names: Selects whether the search should apply to the names of nets in the board.

搜索面板

The search panel is a docked panel that lists information about footprints, zones, nets, ratsnest lines (unrouted segments), and text from the PCB. Show or hide the search panel with **View** → **Panels** → **Search** or use the `Ctrl + G` shortcut.

Search					
<input type="text" value="C1"/>					
Footprints	Zones	Nets	Ratsnest	Text	
Reference	Value	Layer	X	Y	
C101	100nF	Top_layer	160.4010 mm	105.5370 mm	
C102	1nF	Top_layer	141.7320 mm	112.3950 mm	
C103	100nF	Top_layer	143.8910 mm	112.3950 mm	
C104	100nF	Top_layer	160.4010 mm	111.2520 mm	
C105	1nF	Top_layer	164.8460 mm	94.3610 mm	
C106	10pF	Top_layer	136.6520 mm	123.0630 mm	

You can optionally filter the list based on a search string. When no filter is used, all items in the design are listed in the corresponding tab. Items are filtered based on their properties:

- Footprints are filtered by their reference designator and value
- Zones are filtered by the zone name
- Net and ratsnest items are filtered by the net name
- Text (text, textboxes, and dimensions) is filtered by the text content

You can sort the filtered results in ascending or descending order of the value in a particular column by clicking on that column header.

Filters support wildcards: `*` matches any characters, and `?` matches any single character. You can also use [regular expressions](#), such as `/footprint value/`.

The displayed information depends on the item type:

- All items list their name and/or value
- Physical items (footprints, zones, and text) additionally list their layer and X/Y location
- Text additionally lists the type of text object (text, textbox, or dimension)
- Net and ratsnest items additionally list their net name and net class

When you click an item in the search panel, the item is selected in the editing canvas. Depending on what is configured in the  menu, the board editor will also pan and/or zoom to the selected item in the editing canvas. Double-clicking an item in the search panel opens its properties dialog (for net and ratsnest items, the [net classes dialog](#) is opened instead).

3D 查看器

The 3D Viewer shows a 3-dimensional view of the board and the components on the board. You can view the board from different perspectives, show or hide different types of components, cross-probe from the PCB Editor to the 3D viewer, and generate raytraced renders of the board. Show the 3D Viewer with **View** → **3D Viewer** or use the `Alt + 3` shortcut.

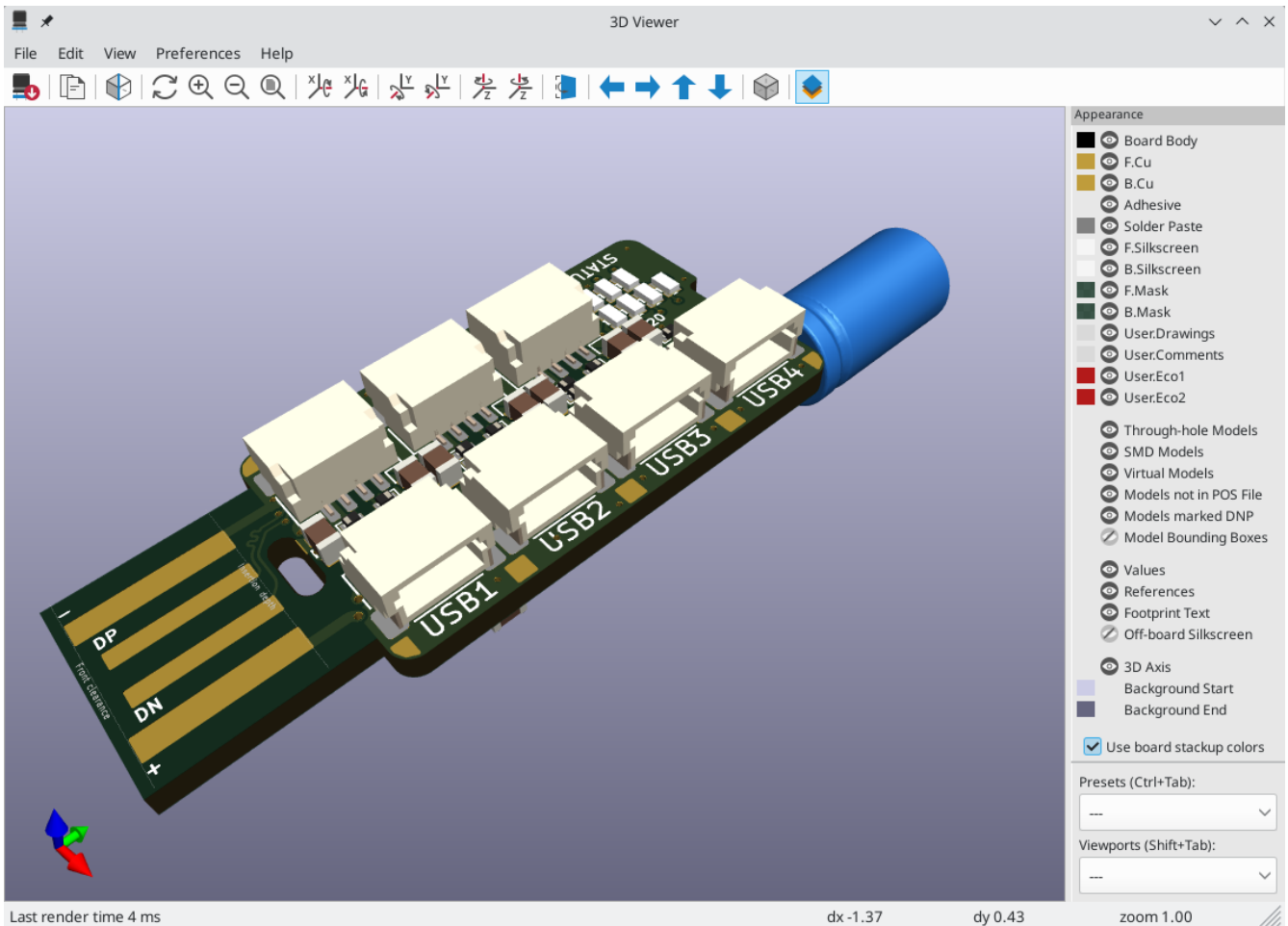

NOTE 仅当 3D 模型文件存在并且已被 [分配到封装](#) 时，元件的 3D 模型才会出现。

NOTE KiCad 标准库中的许多封装还没有为它们创建模型文件。然而，这些封装可能包含一个指向尚不存在的 3D 模型的路径，以期待将来创建 3D 模型。

浏览 3D 视图

用鼠标左键拖动将旋转 3D 视图。默认情况下，这是电路板的中心，但可以通过将光标移动到所需点上并按 Space 将轴心点重置为电路板上的新点。滚动鼠标滚轮将放大或缩小视图。按住 Ctrl 滚动可左右平移视图，按住 Shift 滚动可上下平移视图。使用鼠标中键拖动也可以平移视图。



Different sized 3D grids can be set using the **View** → **3D Grid** menu. Bounding boxes for each component can be enabled with **Preferences** → **Show Model Bounding Boxes**.



当 PCB 编辑器和 3D 查看器同时打开时，在 PCB 编辑器中选择一个封装也会在 3D 查看器中高亮显示该元件。高亮显示的颜色可以在 **偏好设置** → **偏好设置...** → **3D 查看器** → **实时渲染器** → **选择颜色** 中调整。

Appearance Manager

The Appearance Manager is a panel at the right of the viewer which provides controls to manage the visibility, color, and opacity of different types of objects and board layers in the 3D view.

Each layer or type of object in the list can be individually shown or hidden by clicking its corresponding visibility icon. PCB layers can have their colors customized; double-click on the color swatch next to the item type to edit the item's color and opacity. To use the colors selected in the Board Setup dialog's Physical Stackup editor, enable the **use board stackup colors** option.

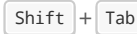
You can save an appearance configuration as a preset, or load a configuration from a preset, using the **Preset** selector at the bottom. The  hotkey cycles through presets; press  repeatedly while holding  to cycle through multiple presets. Several built-in presets are available: "Follow PCB Editor" matches the visibility settings in the PCB editor, "Follow PCB Plot Settings" matches the visibility settings selected in the Plot dialog, and "legacy colors" matches the default 3D Viewer color settings from older versions of KiCad.

Finally, you can save a viewport for later retrieval using the **Viewports** selector at the bottom. You can quickly cycle between saved viewports using ; pressing  repeatedly while holding  will cycle through multiple viewports.

用 3D 查看器生成图像





















当前的 3D 视图可以用 **文件** → **将当前视图导出为 PNG...** 或 **将当前视图导出为 JPG...**，根据所需的图像格式，将其保存为一个图像。也可以用  按钮，或 **编辑** → **复制 3D 图像** 将当前视图复制到剪贴板上。

3D 查看器有一个光线跟踪渲染模式，它使用比默认渲染模式更精确的物理渲染模型来显示电路板。光线跟踪比默认渲染模式慢，但当需要最吸引人的视觉效果时，可以使用它。使用  按钮，或者使用 **偏好设置** → **光线追踪** 来启用光线追踪模式。在光线追踪模式下，3D 网格和选择高亮不会显示。

颜色和其他渲染选项，包括光线跟踪和非光线跟踪模式，都可以在 **偏好设置** → **偏好设置...** → **3D 查看器** 中调整。

3D 查看器控制

许多查看选项是通过顶部的工具栏控制的。

	Reload the 3D model
	Copy 3D image to clipboard
	Render current view using raytracing
	Redraw
	Zoom in
	Zoom out
	Fit drawing in display area
	Rotate X clockwise
	Rotate X counterclockwise
	Rotate Y clockwise
	Rotate Y counterclockwise
	Rotate Z clockwise
	Rotate Z counterclockwise
	Flip board view
	Pan board left
	Pan board right
	Pan board up
	Pan board down
	Enable/disable orthographic projection
	Show/hide the Appearance Manager

网络检查

The Net Inspector is a docked panel that allows you to view statistics about all the nets in a board. It also lets you add, remove, and rename nets. To open the inspector, click the  icon at the top of the Nets section of the Appearance panel, or select **View** → **Panels** → **Net Inspector**.

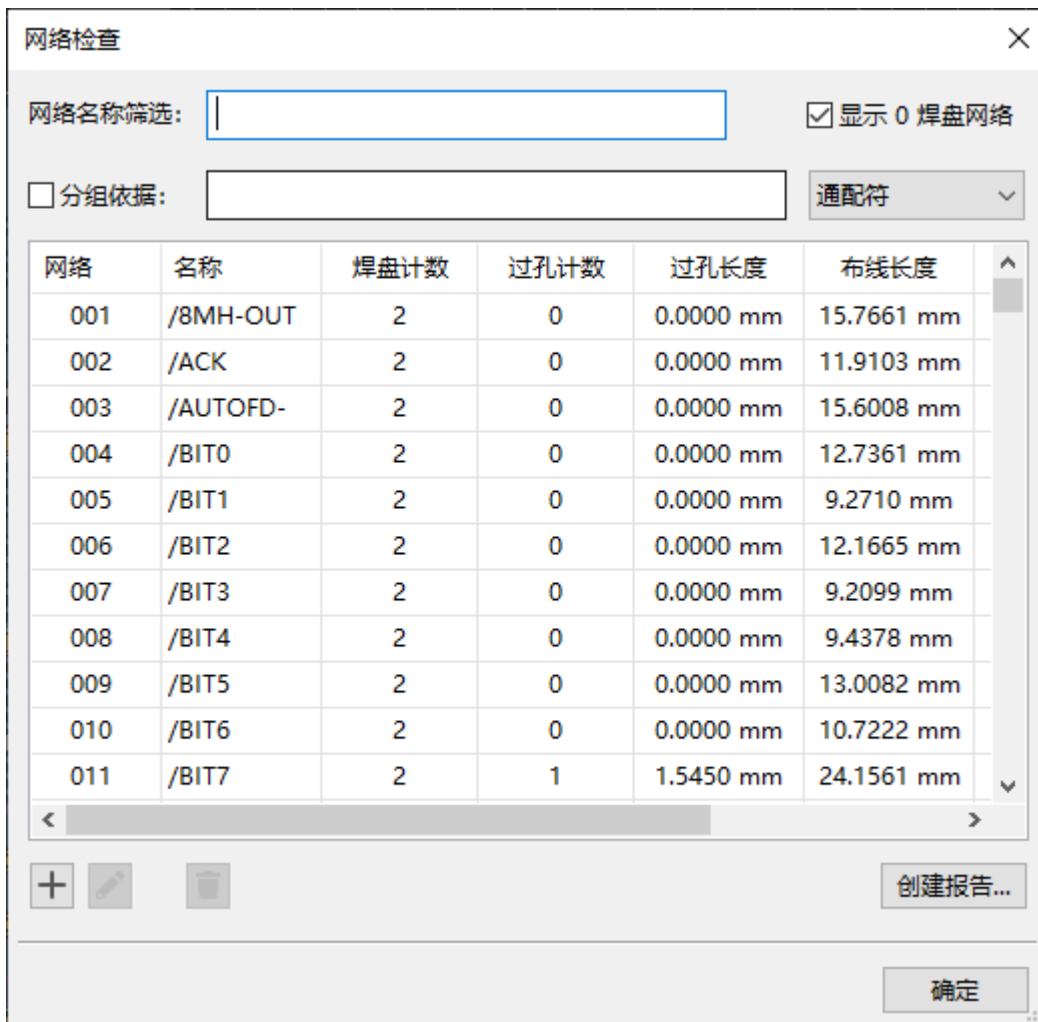

Double-clicking a net in the list will [highlight](#) that net on the board. You can also highlight a net by right clicking it and selecting **Highlight Selected Net**. If multiple nets are selected, this lets you highlight all of them at once. You can remove the net highlighting by right clicking the net's row in the Net Inspector and selecting **Clear Net Highlighting**, in addition to the usual ways of [removing net highlighting](#).

Clicking a column title allows you to sort the list of nets by that column. The Filter box lets you limit the listed nets to those that match the filter string. By default, the filter matches against both net names and net class names, but you can filter by just one or the other by selecting or deselecting **Filter by Net Name** or **Filter by Netclass** under the  menu.



By default, nets with no connections and nets with no pads are not shown. You can choose to show them by selecting **Show Unconnected Nets** and **Show Zero Pad Nets** under the  menu.

The Net Inspector shows the following statistics for each net:

- **Pad Count** is the number of pads with that net, counting both surface mount and through hole pads.
- **Via Count** is the number of vias with that net.
- **Via Length** is the sum total length of all vias with that net. The full height of each via is always counted, even if the connections to the via are such that the full via height is not electrically used. In other words, Via Length is equal to Via Count multiplied by the stackup height of the board.
- **Track Length** is the total length of all track segments in a net, not accounting for topology. For example, in a branching net structure all branches are included in the total length. The track length is also reported



per copper layer.

- **Die Length** is the total of all Pad to Die Length values set for pads on the net.



Each column can be shown or hidden in the  → **Show / Hide Columns** menu. You can save the Net Inspector statistics to a CSV file by clicking  → **Save Net Inspector Report**. The generated report includes all nets and columns, even if they are currently filtered or hidden in the Net Inspector.

Grouping nets

You can group nets in the Net Inspector to organize them and view them more easily. Each group displays the total statistics for all its members, as if the group were a single net. For example, if you have a signal with a series resistor breaking the signal into two nets, you could create a group that contains both of these nets. This would allow you to analyze the total length of both nets, rather than each individually.

You can group nets by their net class by clicking  → **Group by netclass**. Alternatively, you can create custom groups based on net name patterns. To create a new custom group, click  → **Add Custom Group**. Any nets that contain the specified pattern in their name will be shown as part of the group and not shown outside of the group. For example, the pattern `CAN` matches the nets `CAN_RX` and `CAN_TX`.

The pattern can also use regular expressions to match nets if the pattern is surrounded in slashes. For example, the pattern `/^AN/` matches nets `AN0`, `AN1`, etc., but not `CAN`.

To remove a group and release its members back into the full list of nets, click  → **Remove Selected Custom Group**. This action is also available in the right click menu. To remove all groups at once, click  → **Remove All Custom Groups**.

Editing nets

The Net Inspector allows you to create new nets in the board and remove or rename existing nets. To create a new net, right click in the Net Inspector and select **Add Net**, then provide a name for the new net. To delete a net, right click it in the list of nets and choose **Delete Selected Net**. If multiple nets are selected, they will all be deleted. To rename a net, right click it and choose **Rename Selected Net**, then provide a new name.

NOTE

Nets are usually not edited in the board. Instead, it is recommended to define nets in the schematic. Nets are typically managed in the board by creating or modifying a schematic and then using the [Update PCB From Schematic](#) tool to update the nets in the board based on the schematic design. The Net Inspector can be used to manage nets in alternate workflows that do not use a schematic.

NOTE

Nets that are modified in the Board Editor will not effect the schematic until the [schematic is updated from the PCB](#) through the back-annotation process.

Differences between Net Inspector and Length Tuner

The Net Inspector may report different net lengths than the [length tuner](#), because the two tools have different purposes and calculate track/net lengths differently. In short, the Net Inspector sums up the total length of each track segment and via on a net, while the length tuner calculates the effective electrical length of a path between two points on a net. The specific differences are as follows:

- The Net Inspector reports track length as a simple sum of the length of each track segment on a net. The length tuner calculates an effective electrical length of a net, which includes optimizing paths through

pads to calculate the shortest possible path.

- If a routed net has a branching topology, the Net Inspector total includes the length of each branch in the total. The length tuner calculates a point-to-point length; if there are any branches, the length tuner will stop at the closest branch and report the length up to the branch.
- The Net Inspector always includes the effective via height in its via length and total length calculations. If a via connects to tracks on both the top and bottom layers, the full via height is included in the length calculation. Otherwise, only the stackup height between the connected layers is included. The length tuner calculates effective via height in the same way as the Net Inspector, but via height is only included in the length calculation when the **use stackup height** setting is enabled [board constraint settings](#). If the setting is disabled, the length tuner will not include vias in its calculations at all.

生成输出

KiCad can generate and export files in a number of different formats useful for manufacturing PCBs and interfacing with external software. This functionality is available in the File menu in a few different sections.

- The **Fabrication Outputs** section contains the most common operations needed to prepare a PCB for fabrication.
- The **Export** section contains tools for generating files that can be read by external software.
- The **Plot** function allows you to export 2D line drawings of the PCB in various formats.
- The **Print** function allows you to send a view of the PCB to a 2D printer.

制造输出和绘图

KiCad uses Gerber files as its primary plotting format for PCB manufacturing. To create Gerber files, open the **Plot...** dialog from the **File** menu, or select **Gerbers (.gbr)...** from the **Fabrication Outputs** section of the **File** menu. The Plot dialog will open, allowing you to configure and generate Gerber files.

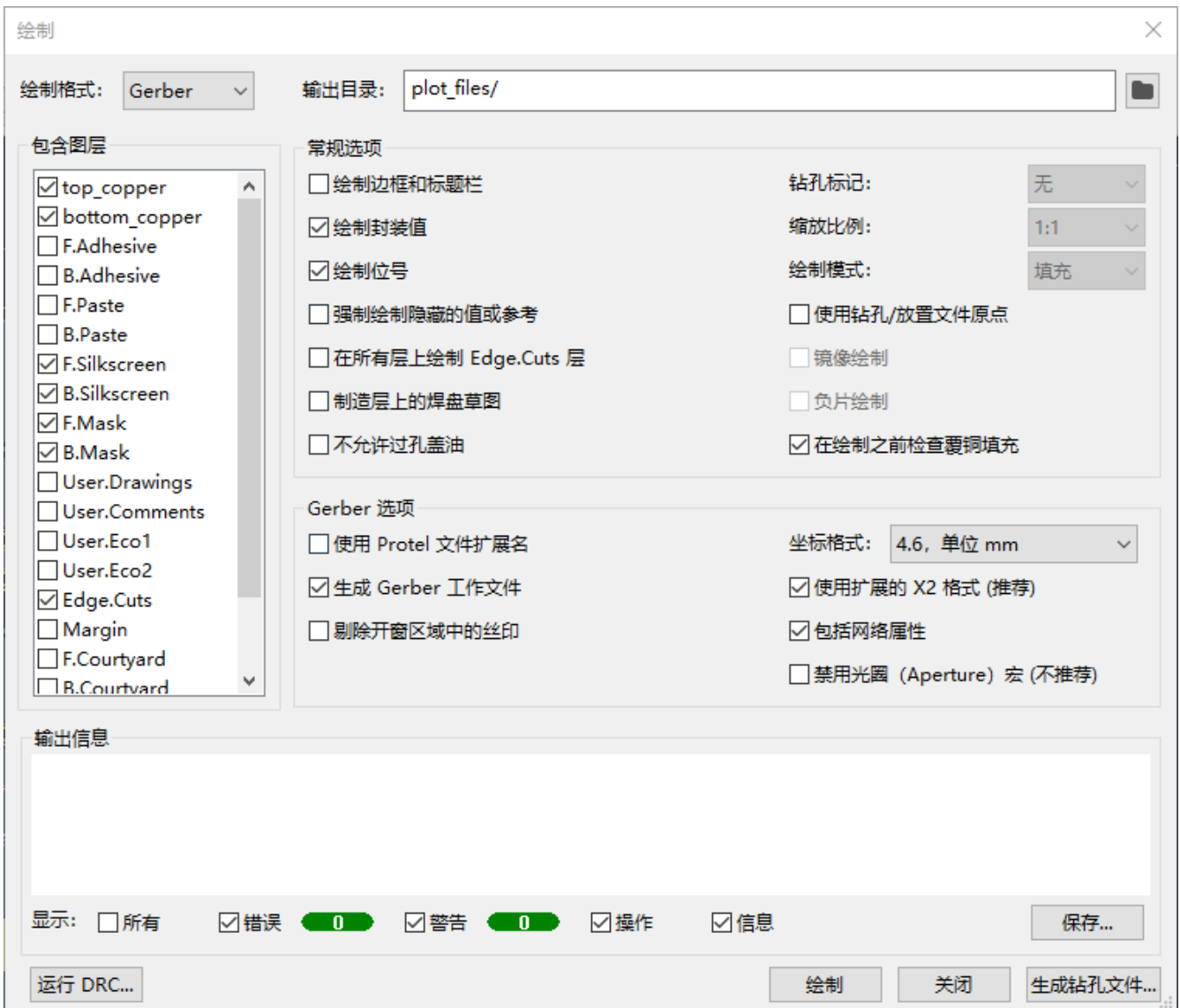

The **Plot** button generates output files according to the selected options. Messages from the plotting process are shown in the Output Messages panel, and can be filtered by the checkboxes.

The **Generate Drill Files...** button opens the [Generate Drill Files dialog](#). **Run DRC...** opens the [Design Rules Checker](#).

绘图选项

- **Include Layers:** Check that every layer used on your board is enabled in the list. Disabled layers will not be plotted.
- **Plot on All Layers:** Selected layers will be included in the plot for each layer selected in the **include layers** list. The additional layers are plotted on top of the base layer. You can reorder these layers using the arrow buttons at the bottom; items that are lower in the list are plotted after (on top of) items that are higher in the list.
- **Output directory:** Specify the location to save plotted files. If this is a relative path, it is created relative to the project directory. Use the  button to open the output directory in a file browser.
- **Plot drawing sheet:** If enabled, the drawing sheet border and title block will be plotted on each layer. This should usually be disabled when plotting Gerber files.
- **Force plotting of invisible values / refs:** If enabled, all footprint values and reference designators will be plotted, even if the field visibility is disabled for some of these fields.

Indicate DNP on fabrication layers: If enabled, fabrication layers (**F.Fab** and **B.Fab**) will indicate when a footprint has the DNP (Do Not Populate) attribute set. DNP footprints are either not plotted on the fabrication layers (**Hide**) or are plotted with an X drawn through them on the front and back fabrication layer (**Cross-out**).

- **Sketch pads on fabrication layers:** If enabled, the outlines of footprint pads will be drawn on fabrication layers (**F.Fab** or **B.Fab**). If **Include pad numbers** is enabled, pad numbers will be drawn as well.
- **Drill marks:** For plot formats other than Gerber, marks may be plotted at the location of all drilled holes. Drill marks may be created at the actual size (diameter) of the finished hole, or at a smaller size.
- **Scaling:** For plot formats that support scaling other than 1:1, the plot scale may be set. The Auto scaling setting will scale the plot to fit the specified page size.
- **Plot mode:** For some plot formats, filled shapes may be plotted as outlines only (sketch mode).
- **Use drill/place file origin:** When enabled, the coordinate origin for plotted files will be the drill/place file origin set in the board editor. When disabled, the coordinate origin will be the absolute origin (top left corner of the worksheet).
- **Mirrored plot:** For some plot formats, the output may be mirrored horizontally when this option is set.
- **Negative plot:** For some plot formats, the output may be set to negative mode. In this mode, shapes will be drawn for the empty space inside the board outline, and empty space will be left where objects are present in the PCB.
- **Check zone fills before plotting:** When enabled, zone fills will be checked (and refilled if outdated) before generating outputs. Plot outputs may be incorrect if this option is disabled!

NOTE

Versions of KiCad before 9.0 had a global control for tenting vias while plotting. In KiCad 9.0, via tenting is globally controlled in [Board Setup](#), and can be overridden in the [properties dialog](#) for each via.

Gerber 选项

- **Use Protel filename extensions:** When enabled, the plotted Gerber files will be named with file extensions based on Protel (`.GBL` , `.GTL` , etc). When disabled, the files will have the `.gbr` extension.
- **Generate Gerber job file:** When enabled, a Gerber job file (`.gbrjob`) will be generated along with any Gerber files. The Gerber job file is an extension to the Gerber format that includes information about the PCB stackup, materials, and finish. More information about Gerber job files is available at [the Ucamco website](#).
- **Subtract soldermask from silkscreen:** When enabled, silkscreen will be automatically removed from board areas that aren't covered by soldermask.
- **Coordinate format:** Configure how coordinates will be stored in the plotted Gerber files. Check with your manufacturer for their recommended setting for this option.
- **Use extended X2 format:** When enabled, the plotted Gerber files will use the X2 format, which includes information about the netlist and other extended attributes. This format may not be compatible with older CAM software used by some manufacturers.
- **Include netlist attributes:** When enabled, the plotted Gerber files will include netlist information that can be used for checking the design in CAM software. When X2 format mode is disabled, this information is included as comments in the Gerber files.
- **Disable aperture macros:** When enabled, all shapes will be plotted as primitives rather than by using aperture macros. This setting should only be used for compatibility with old or buggy CAM software when requested by your manufacturer.

Postscript 选项

- **Scale factor:** Controls how coordinates in the board file will be scaled to coordinates in the PostScript file. Using a different value for X and Y scale factors will result in a stretched / distorted output. These factors may be used to correct for scaling in the PostScript output device to achieve an exact-scale output.
- **Track width correction:** A global factor that is added (or subtracted, if negative) from the size of tracks, vias, and pads when plotting a PostScript file. This factor may be used to correct for errors in the PostScript output device to achieve an exact-scale output.
- **Force A4 output:** When enabled, the generated PostScript file will be A4 size even if the KiCad board file is a different size.

SVG 选项

- **Precision:** Controls how many significant digits will be used to store coordinates.
- **Output mode:** Controls whether the generated SVG file is in color or black and white.

DXF 选项

-

Plot graphic items using their contours: Graphic shapes in DXF files have no width. This option controls how graphic shapes with a width (thickness) in a KiCad board are plotted to a DXF file. When this option is enabled, the outer contour of the shape will be plotted. When this option is disabled, the centerline of the shape will be plotted (and the shape's thickness will not be visible in the resulting DXF file).

- **Use KiCad font to plot text:** When enabled, text in the KiCad design will be plotted as graphic shapes using the KiCad font. When disabled, text will be plotted as DXF text objects, which will use a different font and will not appear in exactly the same position and size as shown in the KiCad board editor.
- **Export units:** Controls the units that will be used in the DXF file. Since the DXF format has no specified units system, you must export using the same units setting that you want to use for importing into other software.

HPGL 选项

- **Default pen size:** Controls the plotter pen size used to create graphics.

PDF options

- **Output mode:** Controls whether the generated PDF file is in color or black and white.
- **Generate property popups for front footprints:** When enabled, interactive popups will be added to the generated PDF containing part information for each footprint on the front of the board.
- **Generate property popups for back footprints:** When enabled, interactive popups will be added to the generated PDF containing part information for each footprint on the back of the board. For details, see the [Schematic Editor documentation](#).
- **Generate metadata from AUTHOR and SUBJECT variables:** Sets the Author and Subject PDF document properties for the generated PDF based on the `AUTHOR` and `SUBJECT` [project text variables](#), if you have defined them.
- **Single document:** When enabled, each layers will be plotted as an individual sheet within a single PDF document. When disabled, each layer will be plotted as a separate PDF file.

钻孔文件

KiCad can generate CNC drilling files required by most PCB manufacturing processes in either Excellon or Gerber X2 format. KiCad can also generate a drill map: a graphical plot of the board showing drill locations. To open the dialog, select the **Drill Files (.drl)...** option from the **Fabrication Outputs** section of the **File** menu, or click the **Generate Drill Files...** button in the Plot dialog.



- **Output folder:** Choose the folder to save generated drill and map files to. If a relative path is entered, it will be relative to the project directory.
- **Drill file format:** Choose whether to generate Excellon drill files (required by most PCB manufacturers) or Gerber X2 files.
- **Mirror Y axis:** For Excellon files, choose whether or not to mirror the Y-axis coordinate. This option should in general not be used when having PCBs manufactured by a third party, and is provided for convenience for users who are making PCBs themselves.
- **Minimal header:** For Excellon files, choose whether to output a minimal header rather than a full file header. This option should not be enabled unless requested by your manufacturer.
- **PTH and NPTH in single file:** By default, plated holes and non-plated holes will be generated in two different Excellon files. With this option enabled, both will be merged into a single file. This option should not be enabled unless requested by your manufacturer.
- **Use alternate drill mode for oval holes:** Controls how oval holes are represented in an Excellon drill file. When not enabled, a route command is used to represent oval holes. This is correct for most manufacturers. Only choose the **Use alternate drill mode** setting if requested by your manufacturer.
- **Generate map:** Choose whether to generate a drill map and, if so, in which format. Supported formats are Postscript, Gerber X2, DXF, SVG, and PDF.
- **Origin:** Choose the coordinate origin for drill files. **Absolute** will use the page origin at the top left corner. **Drill/place file origin** will use the origin specified in the board design.
- **Drill units:** Choose the units for drill coordinates and sizes.
-

Zeros: Controls how zeroes are formatted in an Excellon drill file. Select an option here based on your manufacturer's recommendations.

IPC-2581 files

IPC-2581 files are XML files that contain complete fabrication and assembly data for a board design. If your manufacturer accepts IPC-2581 files, these can replace Gerber files, drill files, and component placement files. To create an IPC-2581 file, select **IPC-2581 File (.xml)...** from the **Fabrication Outputs** section of the **File** menu.

File: ./StickHub.xml

File Format	BOM Columns
Units: Millimeters	Internal ID: Generate Unique
Precision: 4	Manufacturer P/N: Omit
Version: C	Manufacturer: N/A
<input type="checkbox"/> Compress output	Distributor P/N: Omit
	Distributor: N/A

Close Export

IPC-2581 output has the following options:

- **File:** Choose the filename for the generated IPC-2581 file. If a relative path is entered, it will be relative to the project directory.
- **Units:** Choose the units for the generated file. Can be **millimeters** or **inches**.
- **Precision:** Choose the number of digits after the decimal point for numbers in the generated file.
- **Version:** Choose the IPC-2581 standard version (B or C).
- **Compress output:** If enabled, the generated file will be compressed as a ZIP file.
- **Internal ID:** Choose the footprint field to use for the BOM's internal ID column. This can be a generated unique ID or set to any footprint field in the design.
- **Manufacturer P/N:** Choose the footprint field to use for the BOM's manufacturer part number column. This can be omitted or set to any footprint field in the design.
- **Manufacturer:** Choose the footprint field to use for the BOM's manufacturer column. This can be omitted or set to any footprint field in the design.
- **Distributor P/N:** Choose the footprint field to use for the BOM's distributor part number column. This can be omitted or set to any footprint field in the design.
-

Distributor: Choose the footprint field to use for the BOM's distributor column. This can be omitted or set to any footprint field in the design.

ODB++ files

ODB++ output is a database of files that contains complete fabrication and assembly data for a board design. If your manufacturer accepts ODB++ files, these can replace Gerber files, drill files, and component placement files. To create an ODB++ file, select **ODB++ Output File...** from the **Fabrication Outputs** section of the **File** menu.

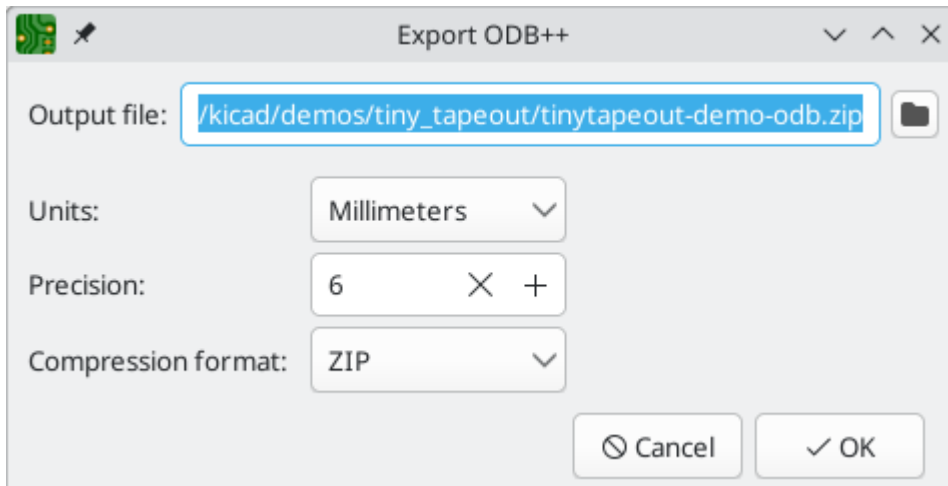

ODB++ output has the following options:

- **Output file:** Choose the filename for the generated ODB++ file. If a relative path is entered, it will be relative to the project directory.
- **Units:** Choose the units for the generated file. Can be **millimeters** or **inches**.
- **Precision:** Choose the number of digits after the decimal point for numbers in the generated file.
- **Compression format:** Choose the type of compression for the generated output. Can be **ZIP**, **TGZ**, or **none**. If none, the output will be a folder.

元件拾放文件

Component placement files are text files that list each component (footprint) on the board along with its center position and orientation. These files are usually used for programming pick-and-place machines, and may be required by your manufacturer if you are ordering fully-assembled PCBs. To create placement files, select **Component Placement (.pos, .gbr)...** from the **Fabrication Outputs** section of the **File** menu.

NOTE

A footprint will not appear in generated placement files if the "Exclude from position files" option is enabled for that footprint. This may be used for excluding certain footprints that do not represent physical components to be assembled. You can also optionally exclude DNP components, depending on your manufacturer's requirements.

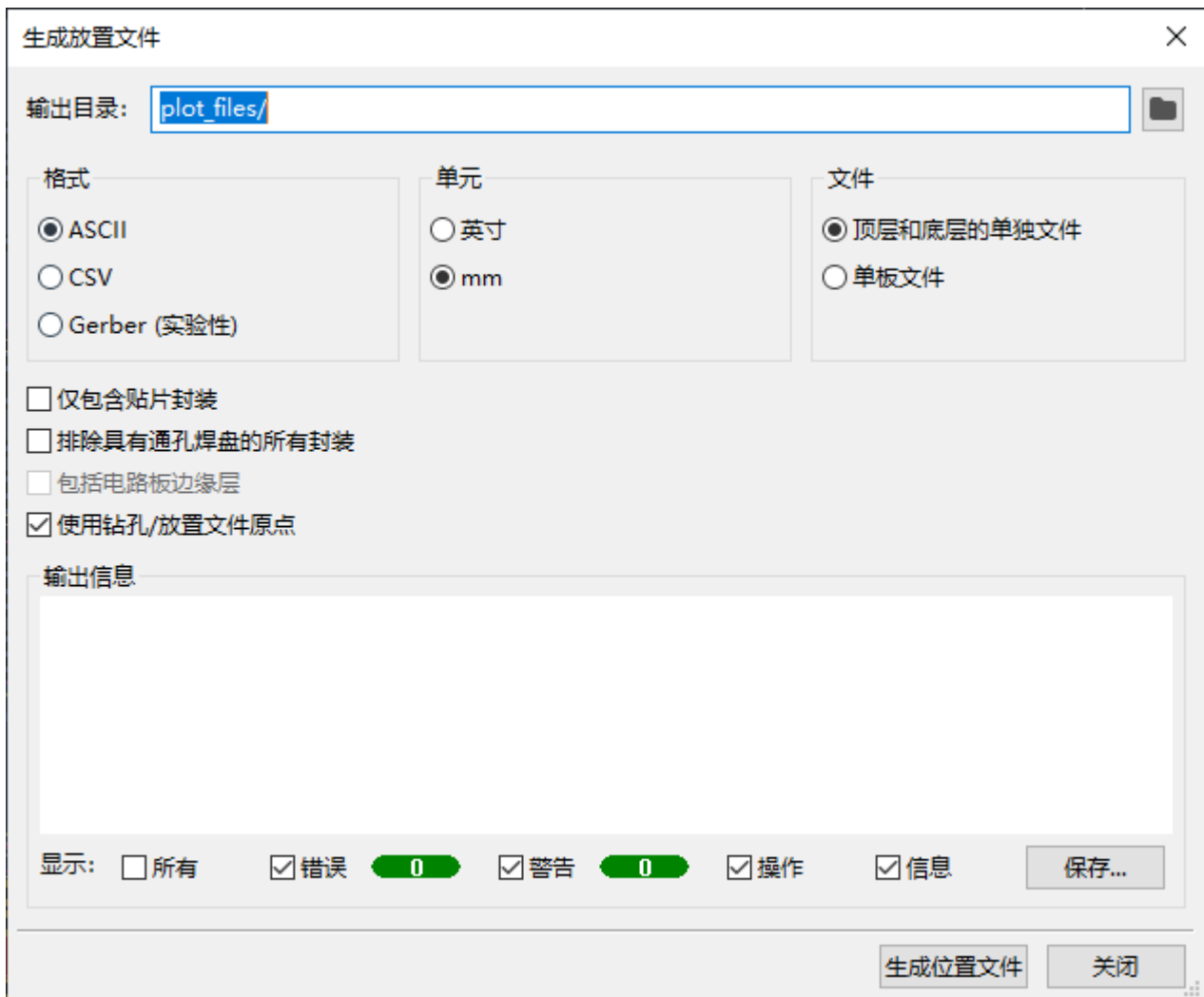

- **Format:** Choose between generating a plain text (ASCII), comma-separated text (CSV), or Gerber X3 placement file format.
- **Units:** Choose the units for component locations in the placement file.
- **Include only SMD footprints:** When enabled, only footprints with the SMD fabrication attribute will be included. Check with your manufacturer to determine if non-SMD footprints should be included or excluded from the position file.
- **Exclude all footprints with through hole pads:** When enabled, footprints will be excluded from the placement file if they contain any through-hole pads, even if their fabrication type is set to SMD.
- **Exclude all footprints with the Do Not Populate flag set:** When enabled, footprints will be excluded from the placement file if they have the Do Not Populate attribute set. Check with your manufacturer to determine if DNP components should be included or excluded from the position file.
- **Include board edge layer:** For Gerber placement files, controls whether or not the board outline is included with the footprint placement data.
- **Use drill/place file origin:** When enabled, component positions will be relative to the drill/place file origin set in the board design. When disabled, the positions will be relative to the page origin (upper left corner).
- **Use negative X coordinates for footprints on bottom layer:** When enabled, the X coordinates will be flipped (negated) for footprints on the bottom layer.

Generate single file with both front and back positions: When enabled, positions for front and back footprints will be saved in a single file. When disabled, separate files will be generated for front and back footprints.

其它制造输出

KiCad 还可以从电路板设计中生成封装报告文件、IPC-D-356 网表文件和物料清单 (BOM)。这些输出格式没有可配置的选项。

打印

KiCad 可以使用文件菜单中的打印操作将电路板视图打印到标准打印机上。

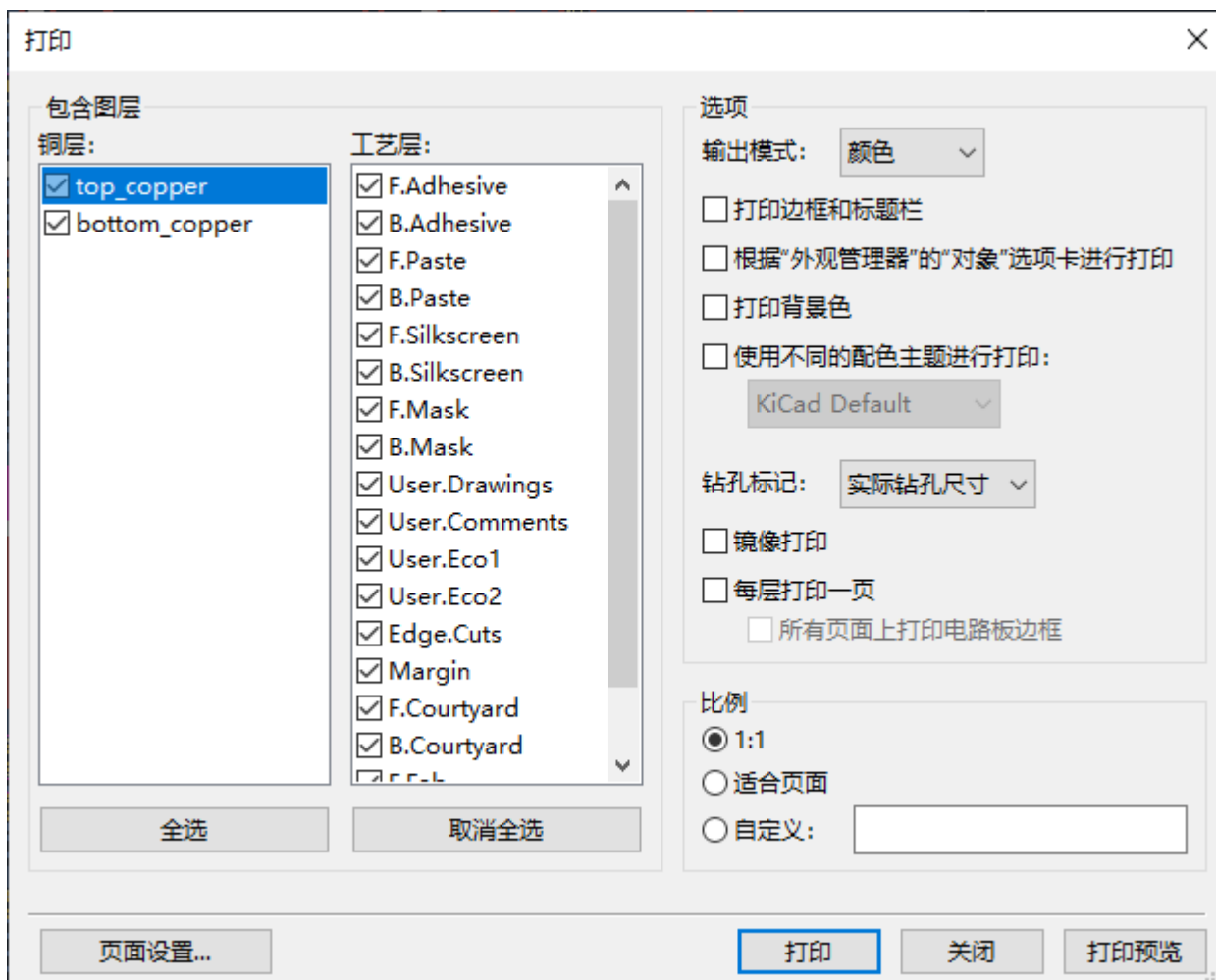

- **Include layers:** Select the layers to include in the printout. Unselected layers will be invisible. Right-click the list for layer selection commands.
- **Output mode:** Choose whether to print in black and white or full color.
- **Print drawing sheet:** When enabled, the page border and title block will be printed.
- **Print according to objects tab of appearance manager:** When enabled, any objects that have been hidden in the Objects tab of the Appearance panel will be hidden in the printout. When disabled, these objects will be printed if the layer they appear on is selected in the Included Layers area.
- **Print background color:** When printing in full color, this option controls whether or not the view background color will be printed.

Use a different color theme for printing: When printing in full color, this option allows a different color theme to be used for printing. When disabled, the color theme used by the board editor will be used for printing.

- **Drill marks:** Controls whether to show drilled holes at their actual size, at a small size, or hide them from the printout.
- **Print mirrored:** When enabled, the printout will be mirrored horizontally.
- **Print one page per layer:** When enabled, each layer selected in the Included Layers area will be printed to an individual page. If this option is enabled, the **Print board edges on all pages** option controls whether to add the Edge.Cuts layer to each printed page.
- **Scale:** controls the scale of the printout relative to the page size configured in Page Setup.

导出文件

KiCad can export a board design to various third-party formats for use with external software. These functions are found in the **Export** section of the **File** menu.

Specctra DSN exporter

The Specctra DSN exporter creates a file suitable for importing into certain third-party autorouter software. This exporter has no configurable options.

GenCAD exporter

The GenCAD exporter creates a GenCAD file for fabrication, testing, or importing into other software.

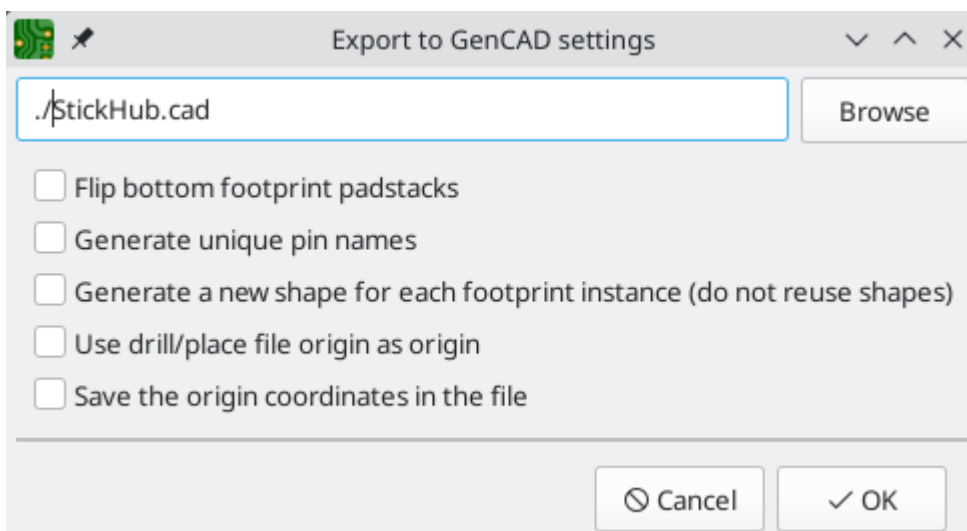

The GenCAD exporter has several options.

- **Flip bottom footprint padstacks:** If enabled, separate flipped padstack definitions will be added for bottom-side footprints. This may be necessary for importing into some third-party software.
- **Generate unique pin names:** If enabled, a suffix will be added to each pin name so that no footprint in the generated file will have two pins with the same name.
- **Generate a new shape for each footprint instance:** If enabled, a unique footprint will be output for every footprint instance, even if two footprints are identical.
-

Use drill/place file origin as origin: If enabled, coordinates in the generated file will be relative to the drill/place file origin.

- **Save the origin coordinates in the file:** If enabled, the selected origin coordinates will be included in the generated file. If not enabled, the origin in the generated file will be set to (0,0).

VRML exporter

The VRML exporter creates a VRML (.wrl) 3D model file containing the PCB and any VRML files specified in footprints. VRML models are suitable for use in applications where visual appearance is important and dimensional accuracy is not critical.

The screenshot shows the 'VRML Export Options' dialog box. It features a title bar with a green PCB icon and standard window controls. The main area is divided into several sections. The 'File name:' section has a text input field with '.StickHub.wrl' and a 'Browse' button. The 'Footprint 3D model path:' section has a text input field with 'shapes3D'. The 'Coordinate Origin Options' section contains two radio buttons: 'User defined origin' (which is selected) and 'Board center origin'. The 'User defined origin:' section includes a 'Units:' dropdown menu set to 'mm', and two text input fields for 'X:' and 'Y:', both containing the value '0'. The 'Units' section has four radio buttons: 'mm', 'meter' (selected), '0.1 Inch', and 'Inch'. Below these are four unchecked checkboxes: 'Ignore 'Do not populate' components', 'Ignore 'Unspecified' components', 'Copy 3D model files to 3D model path', and 'Use relative paths to model files in board VRML file'. At the bottom right, there are 'Cancel' and 'OK' buttons.

The VRML exporter has several options.

- **Coordinate origin options:** Selects the origin for the generated model. If **user defined origin** is selected, you can manually specify the origin point.
- **Units:** Selects the unit system for the generated model. Dimensions in the generated model will be scaled appropriately.
- **Ignore 'Do not populate' components:** If enabled, VRML files for footprints with the 'Do not populate' attribute set will not be included.
- **Ignore 'Unspecified' components:** If enabled, VRML files for footprints with the 'Unspecified' footprint type will not be included.
-

Copy 3D model files to 3D model path: If enabled, VRML files referenced in footprints will be copied into a subdirectory of the directory containing the generated board VRML model, and the generated model will reference the copied files. The subdirectory name is set by the **footprint 3D model path** field. If disabled, VRML files referenced in footprints will be embedded in the generated VRML files.

- **Use relative paths to model files in board VRML file:** If enabled, references to external models will use paths relative to the generated board VRML file. If disabled, the references will use absolute paths. This option is only available when the **copy 3D model files to 3D model path** option is enabled.

IDF exporter

IDF 导出器导出一个 **IDFv3** 兼容的板 (.emn) 和库 (.emp) 文件，用于向机械 CAD 软件传递机械尺寸。导出器导出板子的边框和切口，所有的焊盘和安装孔，包括开槽孔，以及元件的边框；这是与机械设计师互动所需的最基本的机械数据集。IDFv3 规范中描述的所有其他实体目前都没有导出。

NOTE

You must attach IDF component models to your design's footprints before they will be included in the exported model. For more information on attaching models to footprints, see the [footprint documentation](#). Some IDF-specific guidance is included in the [Advanced Topics documentation](#).

NOTE

For more information on creating IDF component models, including descriptions of the IDF utility tools included with KiCad, see the [Advanced Topics documentation](#).

一旦为所有需要的元件指定了模型，就可以导出电路板的模型。在 PCB 编辑器中，选择 **文件** → **导出** → **IDFv3...**。

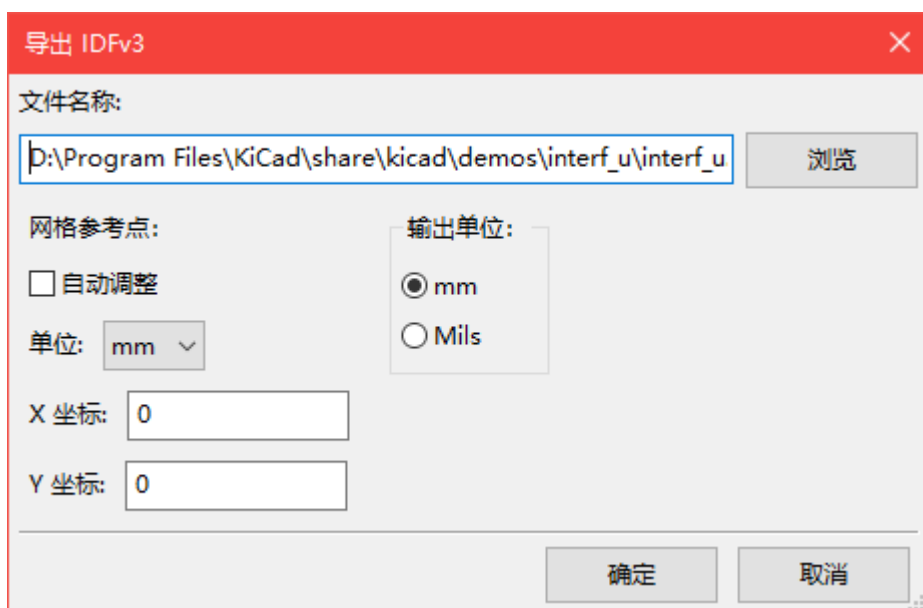

- **Grid reference point:** Choose where the exported model's reference point should be. If the **Adjust automatically** option is selected, KiCad will set the reference point to the centroid of the PCB. Otherwise, the reference point is set relative to the display origin.
- **Output units:** Choose whether the exported model's units are millimeters or mils.
- **Ignore 'Do not populate' components:** If enabled, IDF files for footprints with the 'Do not populate' attribute set will not be included.
- **Ignore 'Unspecified' components:** If enabled, IDF files for footprints with the 'Unspecified' footprint type will not be included.

输出结果可以直接在机械 CAD 应用程序中查看，或使用 `idf2vrm1` [工具](#) 转换为 VRML。

3D model exporter (STEP / GLB / BREP / XAO / PLY / STL)

The 3D model exporter creates a 3D model file from the PCB and any STEP files specified in footprints. A number of formats are supported:

- STEP
- GLB (binary glTF)
- BREP (OCCT-native boundary representation)
- XAO (SALOME/Gmsh)
- PLY
- STL

Different formats may be appropriate for different usecases. For example, STEP models are suitable for use in mechanical CAD applications, while XAO models are useful for physical simulations.

NOTE

KiCad's footprint library includes both STEP and VRML (`.wr1`) versions of each model. However, footprints in KiCad's library only reference the VRML versions of the models. VRML models are not included in STEP exports, but the STEP exporter will instead include the corresponding STEP version of the model if the **substitute similarly named models** option is enabled.

NOTE

KiCad can also export 3D models in [VRML](#) and [IDF](#) formats, but these formats use separate exporters.

To use the 3D model exporter, click **File** → **Export** → **STEP / GLB / BREP / XAO / PLY / STL....**

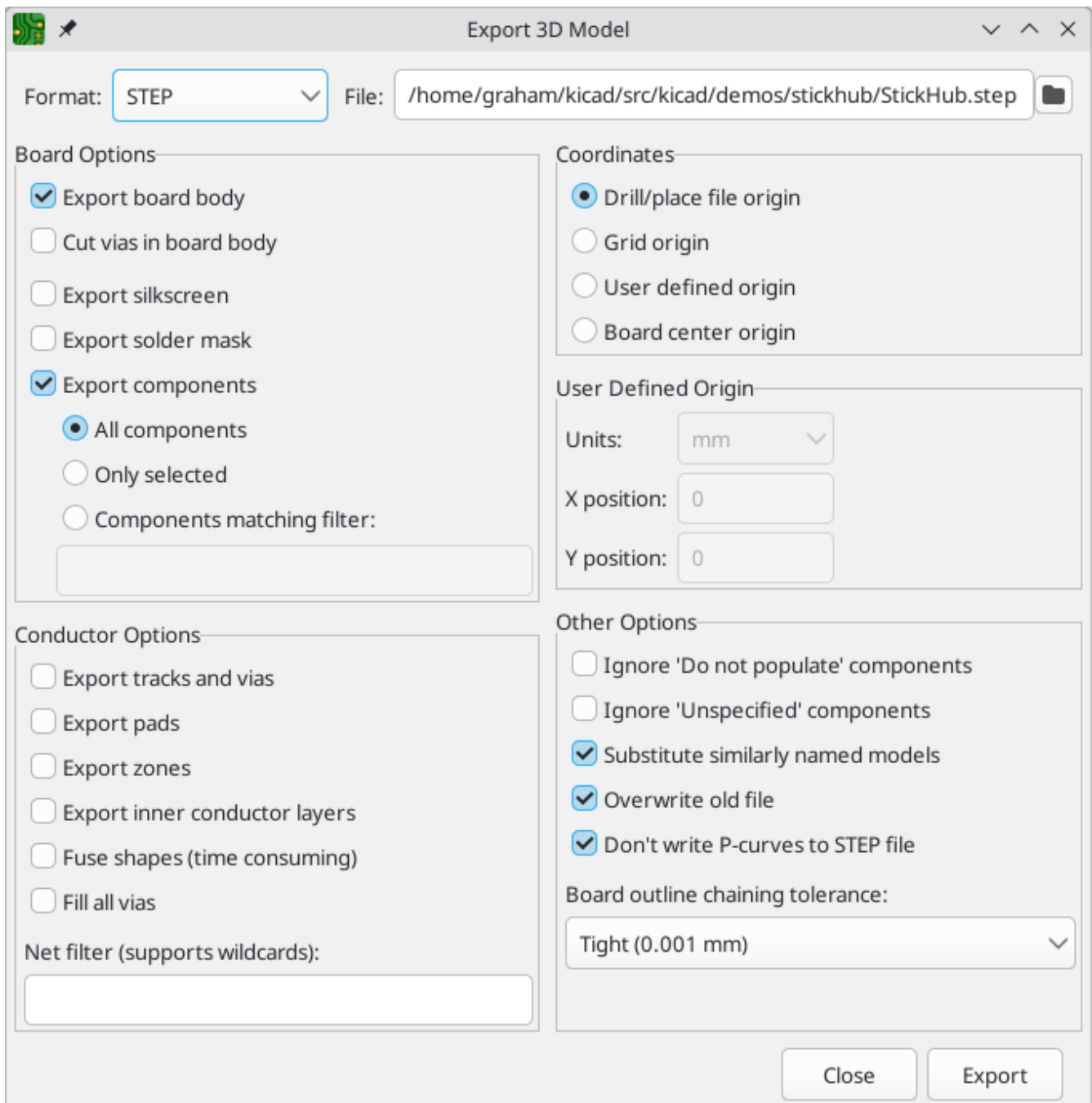

- **Format:** Selects the output format.

Board options

- **Export board body:** If enabled, the board body (non-copper) will be modeled in the exported model.
- **Cut vias in board body:** If enabled, via holes will be cut in the board body even if conductor layers are not modeled.
- **Export silkscreen:** If enabled, silkscreen will be modeled in the exported model. Silkscreen is modeled as a set of flat faces; it is not three-dimensional.
- **Export solder mask:** If enabled, solder mask will be modeled in the exported model. Solder mask is modeled as a set of flat faces; it is not three-dimensional.
- **Export components:** If enabled, 3D models for components will be included in the exported model (but see **Substitute similarly named models**, below). If **All components** is selected, models for all

components in the PCB will be included. If **Only selected** is chosen, only models for the footprints currently selected in the board will be included. If **Components matching filter** is selected, only models for footprints with references matching the filter will be included. The filter supports wildcards and commas, so `C1,R*` will include `C1` and all resistors.

Conductor options

- **Export tracks and vias:** If enabled, tracks and vias on outer layers will be modeled in the exported model.
- **Export pads:** If enabled, pads will be modeled in the exported model.
- **Export zones:** If enabled, zones on outer layers will be modeled in the exported model.
- **Export inner conductor layers:** If enabled, inner conductor layers will be modeled in the exported model.
- **Fuse shapes (time consuming):** If enabled, intersecting geometry will be fused into a single shape. This may make the exported file easier to work with in some tools, but it also significantly increases the export time.
- **Fill all vias:** If enabled, via holes will not be cut in conductor layers.
- **Net filter (supports wildcards):** If filled, only conductors corresponding to nets that match the filter will be modeled. The filter supports wildcards, so `/tx_*` will model `/tx_p` and `/tx_n` conductors.

Coordinates

- **Coordinates:** Selects the origin for the generated model. If **user defined origin** is selected, you can manually specify the origin point.

Other options

- **Ignore 'Do not populate' components:** If enabled, components with the DNP attribute set will not be included in the exported model.
- **Ignore 'Unspecified' components:** If enabled, components with the Unspecified footprint type will not be included in the exported model.
- **Substitute similarly named models:** VRML models cannot be used in STEP, BREP, or XAO exports, but if this option is enabled the exporter will look for an identically named STEP model to include in the export instead of a footprint's specified VRML model. Note that footprints in KiCad's footprint library specify VRML models, but suitably named STEP models are also included for each VRML model. Therefore this option must be enabled in order to export 3D models for footprints from KiCad's library using this dialog.
- **Overwrite old file:** If enabled, the exported model will overwrite an existing file with the same name.
- **Don't write P-curves to STEP file** If enabled, parametric curves will be disabled in the exported STEP model. This reduces the file size, but may reduce compatibility with some software.
- **Board outline chaining tolerance:** Controls the minimum distance between two points for the points to be considered coincident. If the board outline in the exported model is not contiguous, try increasing this tolerance.

Footprint association (CMP) exporter

CMP files are used to sync footprint assignments and some other footprint fields between the PCB and the schematic. You can import CMP files into the schematic using the schematic editor's **File** → **Import** → **Footprint Assignments** menu item. This provides a very limited form of [back annotation](#). It is recommended to use the Update Schematic from PCB tool instead.

This exporter has no configurable options.

Hyperlynx exporter

The Hyperlynx exporter creates a file suitable for importing into Mentor Graphics (Siemens) HyperLynx simulation and analysis software. This exporter has no configurable options.

封装和封装库

KiCad organizes footprints into footprint libraries, which hold collections of footprints. Each footprint in a board is uniquely identified by a full name that is composed of a library nickname and a footprint name. For example, the identifier `Capacitor_SMD:C_0603_1608Metric` refers to the `C_0603_1608Metric` footprint in the `Capacitor_SMD` library.

管理封装库

KiCad 使用一个封装库表，将所有支持的库类型的封装库映射到库的昵称(Nickname)。KiCad 使用一个全局封装库表，以及一个针对每个工程的表。要编辑任何一个封装库表，请使用 **偏好设置** → **管理封装库...**。

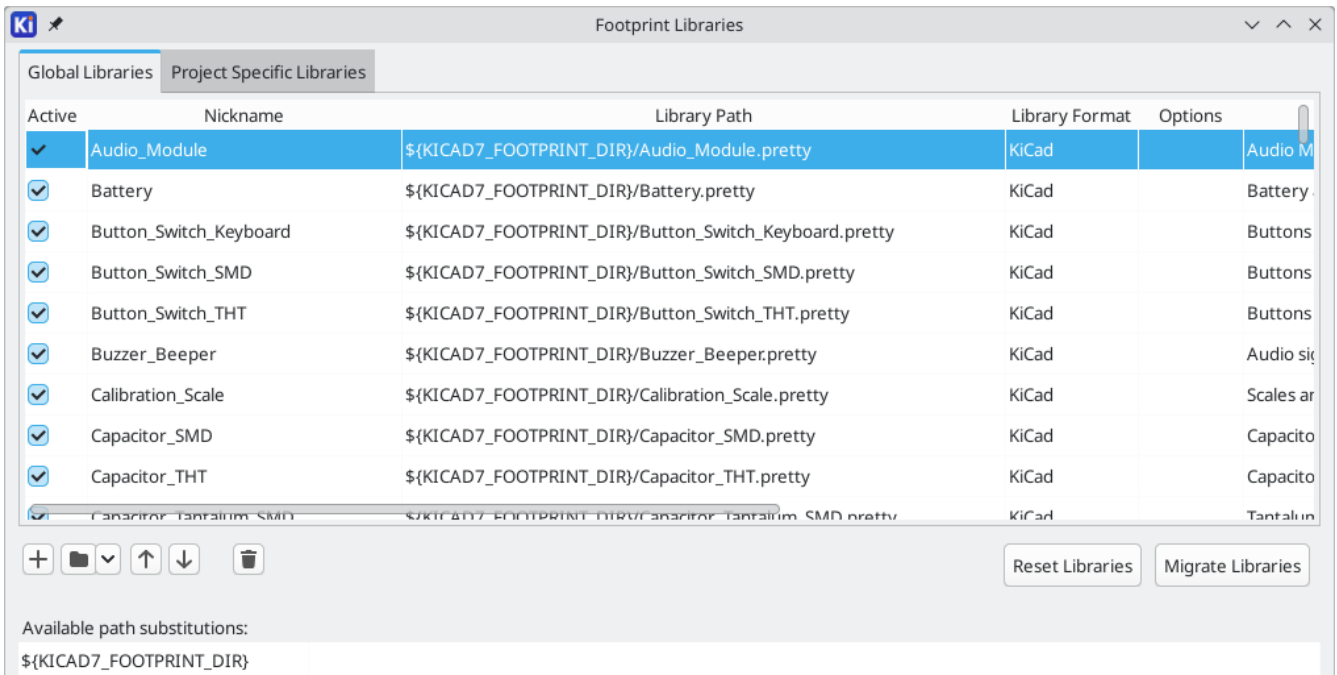

全局封装库表包含了始终可以使用的库列表，无论当前加载的工程是什么。该表保存在 KiCad 配置文件夹中的 `fp-lib-table` 文件中。[该文件夹的位置](#) 取决于正在使用的操作系统。

工程专用的封装库表包含了专门为当前加载的工程提供的库的列表。如果有任何工程专用的封装库，该表将保存在工程文件夹中的 `fp-lib-table` 文件中。

KiCad's footprint library management system allows directly using many types of footprint libraries, including formats that are native to other non-KiCad EDA tools:

- KiCad `.pretty` footprint libraries (folders with `.pretty` extension, containing `.kicad_mod` files)
- KiCad Legacy footprint libraries (`.mod` files)
- Altium Designer (`.PcbLib` or `.IntLib` files)
- CADSTAR PCB Archive (`.cpa` files)
- Eagle footprint libraries (`.lbr` files)
- EasyEDA / JLCEDA Standard Edition (`.json` or `.zip` files)
- EasyEDA / JLCEDA Professional Edition (`.elibz`, `.epro`, or `.zip` files)

GEDA libraries (folders containing `.fp` files)

Non-KiCad footprint libraries, including KiCad Legacy footprint libraries, can be migrated to KiCad `.pretty` format using the **Migrate Libraries** button (see the [migrating libraries](#) section).

NOTE

KiCad only supports writing to KiCad's native `.pretty` format footprint libraries (and the `.kicad_mod` footprint files within them). All other footprint library formats are read-only. To modify a non-KiCad format footprint library, you must first convert it to KiCad format.

初始配置



The first time the PCB Editor (or any other KiCad tool that uses footprints) runs and the global footprint table file `fp-lib-table` is not found, KiCad will guide the user through setting up a new footprint library table. This process is described [above](#). You can re-run this process at any time by clicking the **Reset Libraries**.



WARNING

Resetting your footprint library table will permanently change your footprint library table on disk.

管理表的条目

封装库只有在被添加到全局或工程专用的封装库表中时才能被使用。

通过点击  按钮并选择一个库或点击  按钮并输入库文件的路径来添加一个库。选定的库将被添加到当前打开的库表中（全局或工程专用）。可以通过选择所需的库条目并点击  按钮来删除库。

点击  和  按钮在库表中上下移动所选库。这并不影响在 "封装库浏览器"、"封装编辑器" 或 "添加封装工具" 中显示库的顺序。

通过取消选中第一列中的 **活动** 复选框，可以使库处于非活动状态。非活动库仍在库表中，但不会出现在任何库浏览器中，也不会从磁盘加载，这样可以减少加载时间。

点击范围内的第一个库，然后  点击范围内的最后一个库，可以选择一系列库。

每个库必须有一个独特的昵称：在同一个表中不允许有重复的库昵称。然而，昵称可以在全局和工程库表中重复。工程表中的库比全局表中的同名库更有优先权。

库的昵称不一定要与库的文件名或路径有关。冒号字符（`:`）不能用于库昵称或封装名称，因为它被用作昵称和封装之间的分隔符。

Each library entry must have a valid path. Paths can be defined as absolute, relative, or by [path variable substitution](#).

The appropriate library format must be selected in order for the library to be properly read. The supported formats are listed above. Only KiCad format libraries (`.pretty` folders containing `.kicad_mod` files) can be saved. Other footprint library formats are read-only and must be converted to KiCad format before you can modify them.

有一个可选的描述字段，用于添加库条目的描述。选项字段目前不使用，所以添加选项在加载库时不会有任何影响。

Path Variable Substitution

The footprint library tables support path variable substitution, which allows you to define path variables containing custom paths to where your libraries are stored. PATH variable substitution is supported by using the syntax `${PATH_VAR_NAME}` in the footprint library path.

By default, KiCad defines several path variables which are described in the [project manager documentation](#). Path variables can be configured in the **Preferences** → **Configure Paths...** dialog.

Using path variables in the footprint library tables allows libraries to be relocated without breaking the footprint library tables, so long as the path variables are updated when the library location changes.

NOTE KiCad will automatically resolve versioned path variables from older versions of KiCad to the value of the corresponding variable from the current KiCad version, as long as the old variable is not explicitly defined itself. For example, `${KICAD8_FOOTPRINT_DIR}` will automatically resolve to the value of `${KICAD9_FOOTPRINT_DIR}` if there is no `KICAD8_FOOTPRINT_DIR` variable defined.

`${KIPRJMOD}` is a special path variable that always expands to the absolute path of the current project directory. `${KIPRJMOD}` allows libraries to be stored in the project folder without having to use an absolute path in the project library table. This makes it possible to relocate projects without breaking their project library tables.

使用 GitHub 插件

NOTE KiCad 在 6.0 版本中取消了对 GitHub 库插件的支持。

Migrating footprint libraries to KiCad format

Non-KiCad format libraries, including legacy libraries (`.mod` files), are read-only. They need to be converted to KiCad format (`.kicad_mod` files in a `.pretty` folder) before you can save changes to them.

NOTE As with most KiCad files, newer versions of KiCad can open older-format library files, but older versions of KiCad cannot read files once they have been saved by a newer version of KiCad.

Libraries in other formats can be converted to KiCad libraries by selecting them in the footprint library table and clicking the **Migrate Libraries** button. Multiple libraries can be selected and migrated at once by `Ctrl`-clicking or `shift`-clicking.

Libraries can also be converted one at a time by opening them in the Footprint Editor and saving them as a new library.

创建和编辑封装

A footprint is the physical interface between a component package and a circuit board. Footprints can contain:

- Pads, which define how the component will be physically assembled onto the footprint. When a footprint is added to a board, tracks are routed to pads, and pads provide a magnetic snapping point for the router

to connect the pad to a track. Pad shapes and layers are fully customizable, and pads can have plated holes, unplated holes, or no hole.

- Graphic shapes and text for technical or aesthetic purposes. Graphics can be placed on physical layers (e.g. silkscreen or soldermask) or nonphysical layers. Graphic shapes can also be placed on copper layers, in which case they can make electrical connections.
- 3D models for mechanical CAD and visualization. 3D models are external files that footprints can link to; they are not embedded in footprints.
- Metadata associated with the footprint.

Footprints in KiCad are organized into footprint libraries, which contain zero or more footprints. Generally footprints are logically grouped by footprint category, function, and/or manufacturer. Each library is a folder (usually ending in `.pretty`) containing a `.kicad_mod` file for each footprint in the library.

Footprint editor overview

KiCad provides a footprint editing tool that allows you to create footprint libraries; add, edit, delete, or transfer footprints between libraries; export footprints to files; and import footprints from files. The Footprint Editor can be launched from the KiCad Project Manager or from the Board Editor (**Tools** → **Footprint Editor**). You can also open the Footprint Editor from the [a footprint in the board](#); in this way you can edit either the library copy or the board copy of that footprint in the editor.

NOTE

Editing the library version of a footprint will not affect any copies of that footprint that have been added to a board until the board copy is updated from the library. Conversely, editing the board version of a footprint will not affect the library version of a footprint or any other copies of that footprint in a board.





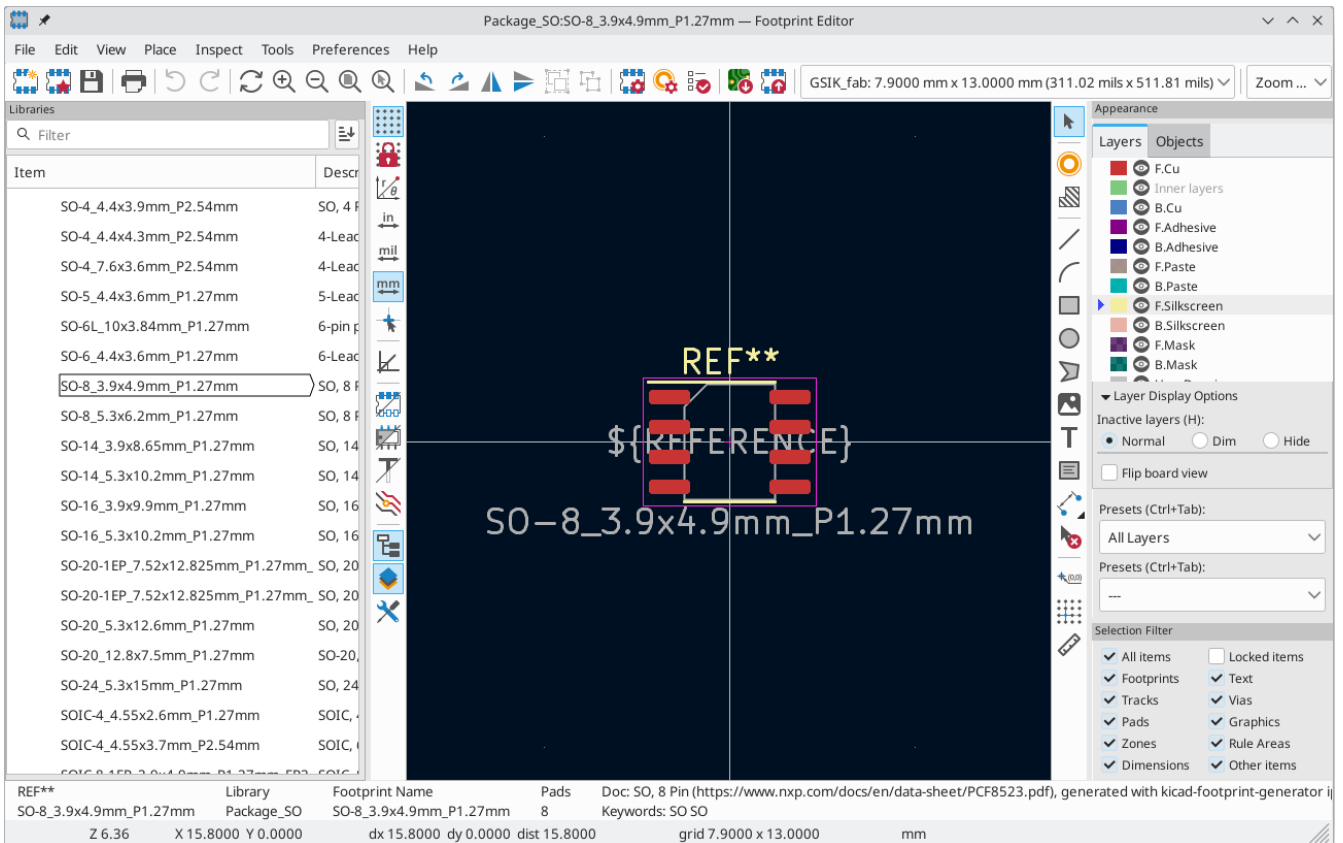

















The Footprint Editor main window is shown below. It has three toolbars for quick access to common features and a footprint viewing/editing canvas. Not all commands are available on the toolbars, but all commands are available in the menus.

In addition to the toolbars, there are collapsible panels for the footprint tree and Properties Manager (not shown) on the left, and the appearance panel and selection filter on the right. The bottom of the window contains a message panel that shows details about the selected object.

















Top toolbar

The main toolbar is at the top of the main window. It has buttons for the undo/redo commands, zoom commands, footprint/pad properties dialogs, and layer/grid management controls.

	Create a new footprint in the selected library.
	Create a new footprint in the selected library using a footprint wizard.
	Save the currently selected footprint.
	Print the currently selected footprint.
	Undo last edit.
	Redo last undo.
	Refresh display.
	Zoom in.
	Zoom out.
	Zoom to fit footprint in display.
	Zoom to fit selection.
	Rotate selected item(s) counter-clockwise.
	Rotate selected item(s) clockwise.
	Mirror selected item(s) horizontally.
	Mirror selected item(s) vertically.
	Add the selected item(s) to a group .
	Remove the selected item(s) from a group .
	Edit the current footprint's properties .
	Edit the selected pad's properties .
	Open the current footprint's datasheet.
	Run the footprint checker to test the current footprint for design errors.
	Edit a footprint in the current board in the footprint editor.
	Insert current footprint into the board.



















左侧工具栏显示控件

The left toolbar provides options to change the display of items in the Footprint Editor.

	Turn grid display on/off. Note: by default, hiding the grid does not disable grid snapping. This behavior can be changed in the Display Options section of Preferences.
	Turn item-specific grid overrides on/off.
	Switch between polar and Cartesian coordinate display in the status bar.
  	Display/entry of coordinates and dimensions in inches, mils, or millimeters.
	Switch between full-screen and small editing cursor (crosshairs).
	Switch between free angle and 45 degree mode for placement of new tracks, zones, graphical shapes, dimensions, and other objects. You can also toggle between free angle and 45 degree mode using <code>Shift</code> + <code>Space</code> .
	Switch display of pads between filled and outline mode.
	Switch display of graphic items between filled and outline mode.
	Switch display of text between filled and outline mode.
	Switch the non-active layer display mode between Normal and Dim. Note: this button will be highlighted when the non-active layer display mode is either Dim or Hide. In both cases, pressing the button will change the layer display mode to Normal. The Hide mode can only be accessed via the controls in the Appearance Panel or via the hotkey <code>Ctrl</code> + <code>H</code> .
	Toggle display of library and footprint tree.
	Show or hide the Appearance and Selection Filter panels on the right side of the editor.
	Show or hide the Properties Manager panel on the left side of the editor.

Right toolbar tools

Placement and drawing tools are located in the right toolbar.

	Selection tool (the default tool).
	Add pad : click on the board to place a pad.
	Add rule area : Rule areas, formerly known as keepouts, can restrict the placement of items and the filling of zones and can also define named areas to apply specific custom design rules to.
	Draw lines . Note: Lines are graphical objects and are not the same as tracks placed with the Route Tracks tool. Graphical objects cannot be assigned to a net.
	Draw arcs : pick the center point of the arc, then the start and end points. By right clicking this button, you can change the arc editing mode between a mode that maintains the existing arc center and a mode that maintains the arc radius.
	Draw rectangles . Rectangles can be filled or outlines.
	Draw circles . Circles can be filled or outlines.
	Draw graphical polygons . Polygons can be filled or outlined. Note: Filled graphical polygons are not the same as filled zones: graphical polygons cannot be assigned to a net and will not keep clearance from other items.
	Draw bezier curves : draw a bezier curve. Each curve is defined by its start and end points and two control points. Subsequent curves start as tangent to the previous one. Use Backspace to cancel the previous point.
	Add bitmap image for reference. Reference images are not included in fabrication outputs.
	Add text .
	Add a textbox .
	Add a table .
	Add dimensions . Dimension types are described in more detail below.
	Deletion tool: click objects to delete them.
	Anchor tool. Left-click to set the anchor position (origin) of the footprint.
	Set grid origin .
	Interactively measure the distance between two points.

Browsing, modifying, and saving footprints

The  button displays or hides the list of available libraries, which allows you to select an active library. When a new footprint is created, it will be placed in the active library.

Clicking on a footprint name opens that footprint in the editor, and hovering the cursor over the name of a footprint displays a preview of the footprint.

After modification, a footprint can be saved in the current library or a different library. To save the modified footprint in the current library, click the  button.

To save the footprint changes to a new footprint, click **File** → **Save As...** The footprint can be saved in the current library or a different library, and a new name can be set for the footprint.

To create a new file containing only the current footprint, click **File** → **Export** → **Footprint...** This file will be a standard footprint library which will contain only one footprint.

The editor can also open footprints from the board. To edit a footprint from the board, right click a footprint in the Board Editor and select **Open in Footprint Editor** (**Ctrl** + **E**). Alternatively, you can open a board footprint by pressing the  button in the Footprint Editor top toolbar and selecting the desired footprint.

Editing and saving the board copy of a footprint will only update that footprint in the board; it will not update other copies of that footprint in the board, and it will not change the original library copy of the footprint. When you open the board copy of a footprint, the Footprint Editor displays an info bar that warns you the library copy will not be modified. You can click the link in this info bar to open the library version of the footprint instead, or press **Ctrl** + **Shift** + **E**.

Creating a new footprint library

You can create a new footprint library by clicking **File** → **New Library...** At this point you must choose whether the new library should be added to the global footprint library table or the project footprint library table. Libraries in the global library table will be available to all projects, while libraries in the project library table will only be available in the current project.

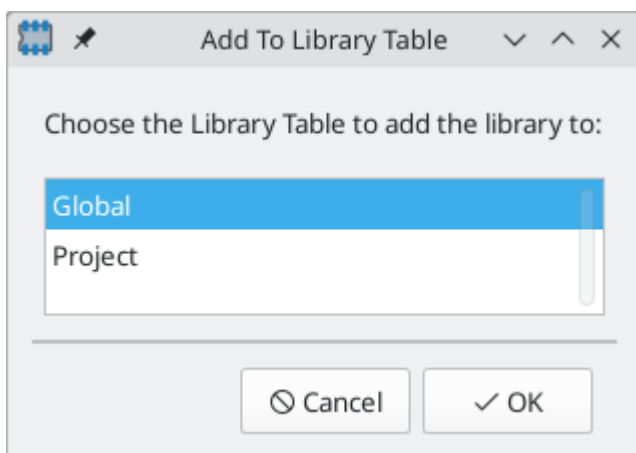

Following selection of the library table, you must choose a name and location for the new library. A new, empty library will be created at the specified location.

Creating a new footprint

To create a new footprint in the current footprint library, click the  button or click **File** → **New Footprint...** A new, untitled footprint will be created in the selected library.

To set the name of the footprint, open its [properties dialog](#) ( button or **E**). The name will set the name of the footprint, which is used when assigning a footprint to a symbol, and is also used as the filename of the footprint file on disk.

The new footprint will be empty except for several default text items. The footprint contains two default (mandatory) footprint fields, Reference and Value. Reference contains the text REF**, which will be replaced with the reference designator of the footprint's corresponding symbol when the [footprint is added to the board](#). Value is initially set to Untitled, which can be changed, but this will also be updated with the contents of the corresponding symbol's Value field when the footprint is added to the board. Finally, there is a footprint text item containing the string `${REFERENCE}`, which is a [text variable](#) that will resolve to the value of the footprint's Reference field once the footprint is on a board.

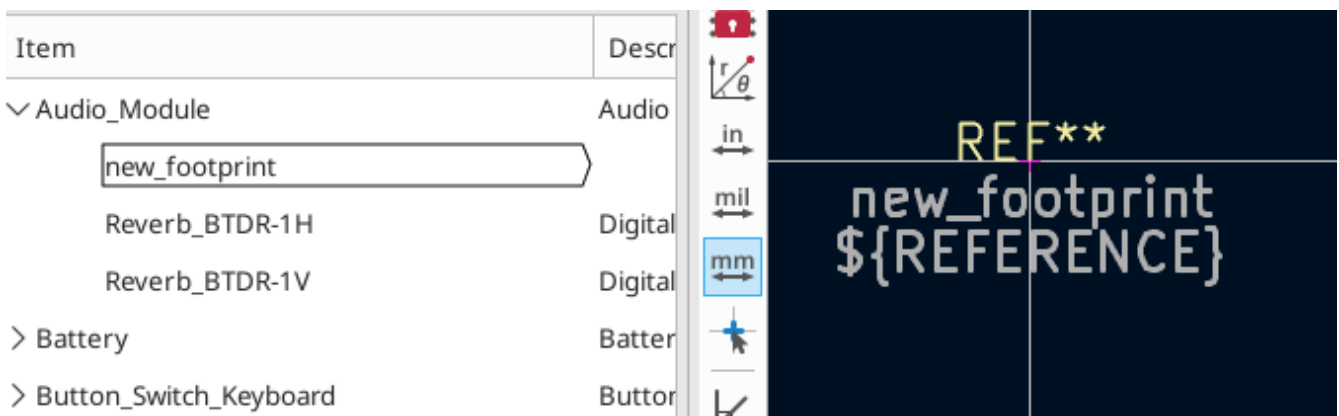

These items are centered on the footprint's anchor (origin point), which is indicated with a magenta cross symbol. The anchor can be repositioned (changing the (0, 0) point for the footprint) by selecting the  button and clicking on the new desired anchor position.

NOTE

Rather than manually creating a footprint, for some common footprints you can use a [footprint wizard](#) to create a footprint based on a set of parameters.

Editing footprint properties

Footprints have a number of properties and metadata items that can be defined. These include text fields, attributes that can be set or not (such as Do Not Populate), clearance and zone connection settings, and 3D model paths. These are initially defined in the library copy of the footprint, but they can be modified on a per-instance basis once a footprint is added to a board. In other words, two copies of the same footprint on a single board can their properties edited separately.

Some properties, namely text fields and attributes, will be automatically set for each footprint in a board based on the fields and attributes in the footprint's corresponding schematic symbol. Fields and attributes are synced from symbols to footprints when you perform the [Update PCB From Schematic](#) action. They are also synced from footprints back to symbols when you perform the Update Schematic From PCB action.

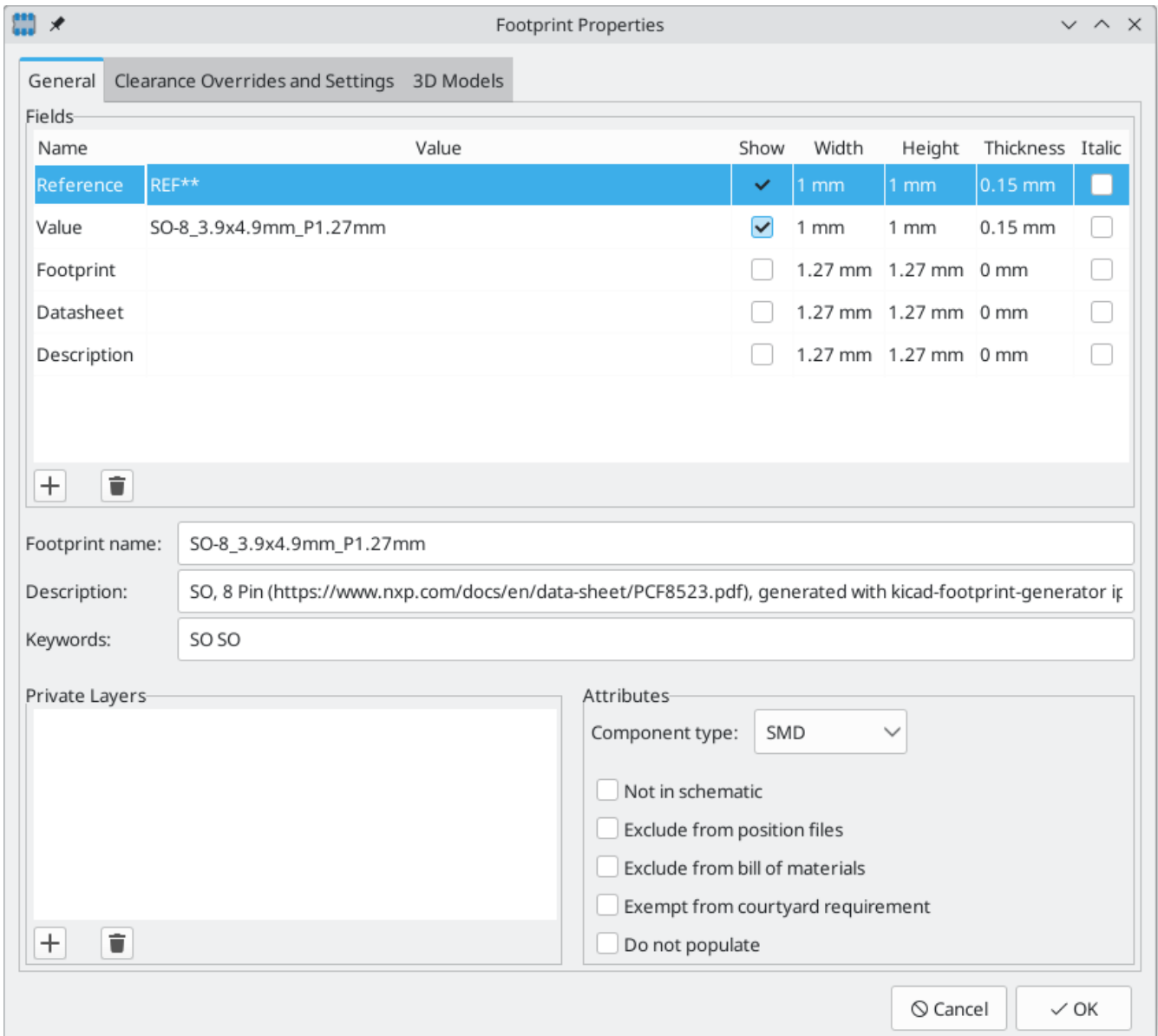

To edit footprint properties, click the  button to show the Footprint Properties dialog. You can also double click an empty spot in the editing canvas.

Footprint name, description, and keywords

The footprint name, description, and keywords describe the footprint itself. Together they are intended to describe the footprint and help you select an appropriate footprint for each component. They are also used when searching for footprints in the Footprint Editor and the Add Footprint dialog.

The **footprint name** contains the name of the footprint. This is the same as the footprint's filename on disk, and is also initially the same as the footprint's `Value` field. However, the `Value` field can be edited in the footprint editor, and when a footprint is added to a board, its `Value` field will be updated with the value of the footprint's corresponding symbol.

The **description** is a description of the footprint. It should be human readable, but it is also used when searching for a footprint.

NOTE

This description property is specifically a description of the **footprint**. This is not to be confused with the `Description` field, which will be set to the description of the footprint's corresponding **symbol** when the footprint is added to a board.

The **keywords** are space-separated words related to the footprint. They are used when searching for a footprint.

Footprint fields

Footprints contain multiple fields, which are named values containing information related to the footprint. Fields can be visible and shown on any board layer, or they can be hidden and only shown in the footprint's properties. Some fields have special meaning to KiCad: `Reference` and `Footprint` are both used by KiCad to identify schematic symbols and PCB footprints, for example. Other fields may contain information that is important for a design but is not interpreted by KiCad, like pricing or stock information for a part.

Any fields defined in a library footprint will be included in the footprint when it is added to a board. You can also add new fields to footprints in the board. Whether they are in the library footprint or not, these fields can then be edited on a per-footprint basis in the board. Symbol fields are also transferred to the board and added as fields in the corresponding footprint.

NOTE

Footprint fields are different than graphic text. Fields are named, i.e. they have both a name (`Reference`) and a value (`R101`), whereas footprint text only has a value. Fields can be added to and deleted from footprints in a board in the Footprint Properties dialog, while text items can only be added to a footprint in the footprint editor. Fields are also synced between footprints and their corresponding symbols in the schematic. Before KiCad version 8.0, footprints did not have named fields, only graphic text.

All library footprints are defined with four default fields which correspond to the [default fields in library symbols](#): `Reference`, `Value`, `Datasheet`, and `Description`. These default fields cannot be deleted. The `Reference` field initially has the value `REF**`, while the `Value` field is initially set to the name of the footprint. In the board, the values of the four default fields will be set to the values of the matching fields in the footprint's corresponding symbol.

NOTE

The `Description` footprint field is the description of the symbol, not the footprint, and will be overwritten by the value of the corresponding symbol's description. Footprints have a separate footprint description property (not a field), which is specifically intended for a description of the footprint.

Fields each have an associated layer, which determines which board layer the field will be placed on. Fields can also be visible or hidden.

To edit an existing footprint field, double-click the field, select it or hover and press `E`, or right-click on the field text and select **Properties...**

To add new fields, delete optional fields, or edit existing fields, use the  icon on the main tool bar to open the Footprint Properties dialog. Fields can be arbitrarily named, but names starting with `ki_`, e.g. `ki_description`, are reserved by KiCad and should not be used for user fields.

Fields have a number of properties, each of which is shown as a column in the properties grid. Not all columns are shown by default; columns can be shown or hidden by right clicking on the grid header and selecting or deselecting columns from the menu.

封装属性

Footprints have several attributes, which are properties of the footprint that affect how it is handled by other parts of KiCad.

Every footprint has a **component type**: **SMD**, **Through hole**, or **Unspecified**. A footprint's type affects KiCad's behavior in a few ways:

- Footprint type controls the default type of new pads added to the footprint. For **through hole** and **Unspecified** footprints, new pads will be through hole by default, although they can be changed after creation. For **SMD** footprints, new pads will be SMD by default.
- Footprint type can be used to filter footprints from component placement files as well as other exports, such as STEP files. Additionally, the footprint type is included as metadata in IPC-2581 exports.
- Footprint 3D models can be shown and hidden in the 3D viewer based on their type. For example, SMD models can be hidden while through hole models are still displayed.
- Footprints of different types are reported separately in the [Board Statistics dialog](#).
- DRC will report footprints containing pads that do not match the parent footprint's type, for example through hole pads in an SMD footprint.

If **not in schematic** is checked, KiCad will not expect the footprint to correspond to a symbol in the schematic. When updating a PCB from the schematic, KiCad will ordinarily remove footprints that don't have corresponding symbols according to the **delete footprints with no symbols** setting. However, such footprints will not be deleted when they have **not in schematic** set.

If **exclude from POS files** is checked, KiCad will not include the footprint in component placement file exports.

If **exclude from bill of materials** is checked, the component will not be included in bill of materials exports in either the schematic or PCB editors. This attribute is synced to and from the footprint's corresponding schematic symbol.

If **exempt from courtyard requirement** is checked, the footprint will not trigger a DRC violation if it does not contain a courtyard. Without this attribute set, a footprint without graphics on the `F.Courtyard` or `B.Courtyard` layer will cause a "Footprint has no courtyard defined" DRC violation.

The **do not populate** attribute is primarily a schematic symbol attribute, and is synced to and from the footprint's corresponding schematic symbol. Footprints with this attribute set can optionally be excluded from component placement file exports and some other types of outputs. These footprints can also be hidden in the 3D viewer.

Private footprint layers

Footprints can have private footprint layers, which are layers that can be viewed and edited in the Footprint Editor but are not shown in the footprint when it is added to a board. Therefore any objects that are on private layers will not be visible in the PCB Editor or included in PCB fabrication outputs. This may be useful, for example, for notes or graphics that are of interest when drawing or editing a footprint but not needed at the board level.

Any of the existing `User.*` layers (`User.Drawings`, `User.Comments`, `User.Eco1`, `User.1`, etc.) can optionally be a private layer. To make a layer private, add a private layer in the **General** tab of the footprint properties dialog, then select the desired layer. Any objects on that layer will not be shown on the board.

Clearance overrides and settings

The **Clearance Overrides and Settings** tab holds settings for footprint-specific overrides to board clearance and mask/paste expansion, pad-to-zone connections, and net tie settings for allowing pads within the footprint to short different nets.

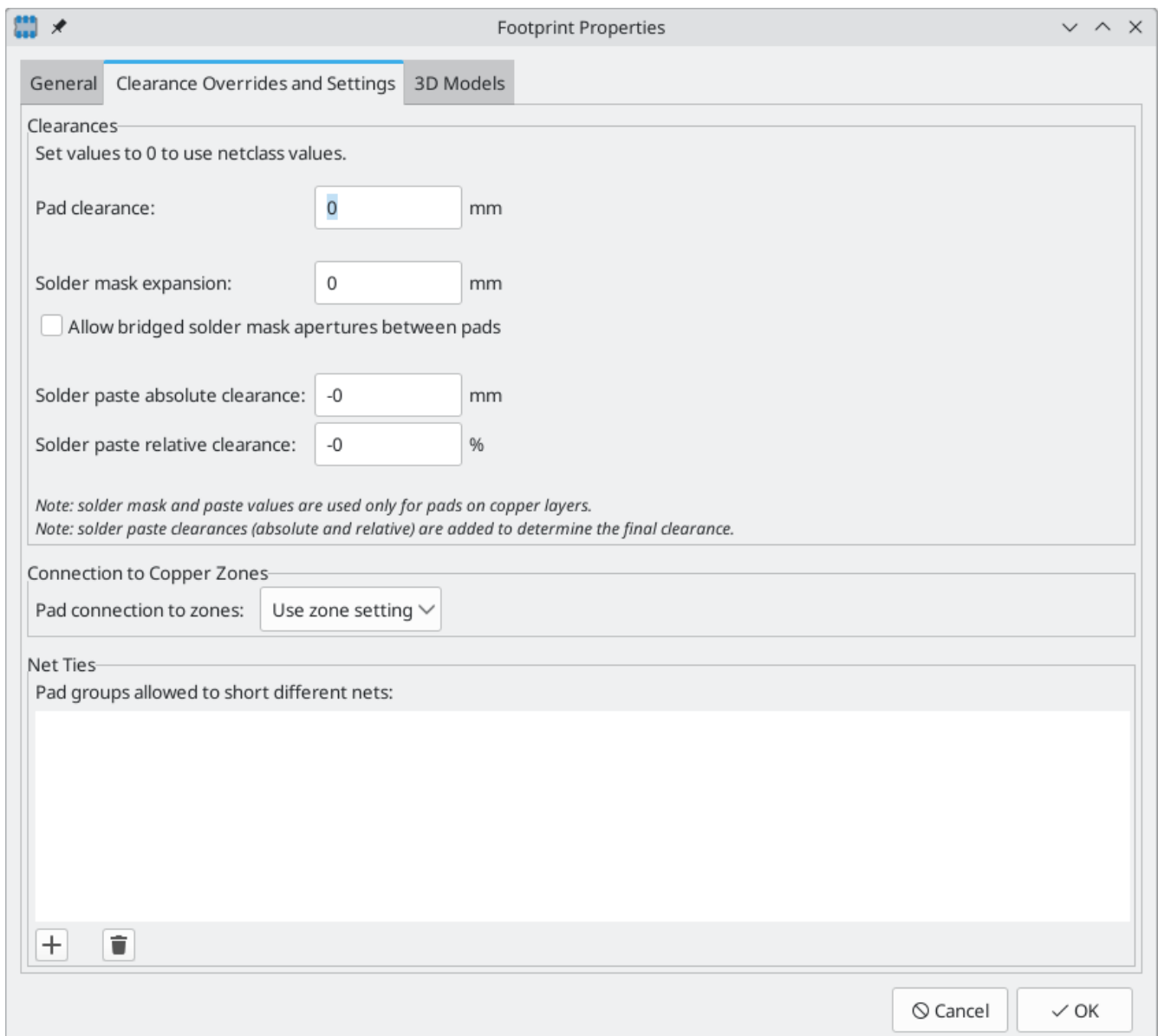

The screenshot shows the 'Footprint Properties' dialog box with the 'Clearance Overrides and Settings' tab selected. The dialog has three tabs: 'General', 'Clearance Overrides and Settings', and '3D Models'. The 'Clearances' section includes a note 'Set values to 0 to use netclass values.' and several input fields: 'Pad clearance' (0 mm), 'Solder mask expansion' (0 mm), 'Solder paste absolute clearance' (-0 mm), and 'Solder paste relative clearance' (-0 %). There is an unchecked checkbox for 'Allow bridged solder mask apertures between pads'. Below this is a 'Connection to Copper Zones' section with a dropdown menu set to 'Use zone setting'. The 'Net Ties' section has a label 'Pad groups allowed to short different nets:' and an empty list area with '+' and '-' icons. At the bottom right are 'Cancel' and 'OK' buttons.

Pad clearance controls the minimum clearance between the footprint's pads and any copper shape (tracks, vias, pads, zones) on a different net. This value is normally set to 0 which will cause the pad clearance to be inherited from the board's design rules and netclass rules. This value can be overridden for individual pads by setting the pad's clearance to a nonzero value.

The aperture appearing on any technical layer will have the same shape and size as the pad shape on the copper layer(s). In the PCB manufacturing process, the manufacturer will often change the relative size of mask and paste apertures relative to the copper pad size, but since this size change is specific to a manufacturing process, most manufacturers expect the design data to be provided with the apertures set to the same size as the copper pads. For specific situations where you need to oversize or undersize a technical layer aperture in the design data, you can use the settings here. These values can be overridden for individual pads by setting the pad's expansion or clearance to a nonzero value.

Solder mask expansion controls the size difference between the pad shape and the aperture shape on the F.Mask and B.Mask layers. A positive number means the solder mask aperture will be larger than the copper shape. This number is an inflation applied to all directions. For example, a value of 0.1mm here will cause the solder mask aperture to be inflated by 0.1mm, meaning that there will be an 0.1mm border on all sides of the pad and the solder mask opening will be 0.2mm wider than the pad when measured along a given axis.

Solder paste absolute clearance controls the size difference between the pad shape and the aperture shape on the F.Paste and B.Paste layers. Its behavior is otherwise identical to the behavior of the **solder mask expansion** setting.

Solder paste relative clearance allows setting a solder paste clearance value as a percentage of the pad size rather than an absolute distance value. If both relative and absolute clearances are specified, they are added together to determine the solder paste aperture size.

Pad connection to zones controls whether the footprint's pads will have solid, thermal relief, or no connection to zones. Like the other overrides, this one may be set for an individual pad or for an entire footprint. The default setting for this control is **From zone setting**, which uses the connection mode specified in the connection zones' properties. This setting can be overridden for individual pads by setting the pad's connection mode to a value other than **From parent footprint**.

Creating net ties

Footprints can act as net ties, where two separate nets are electrically connected by copper. Connecting nets together would normally cause a DRC error due to violating the clearance between two nets, but a footprint can be configured to short nets without causing a DRC violation. This can be used to connect multiple grounds at a specific location, to make kelvin sense connections to a component, or for other applications.

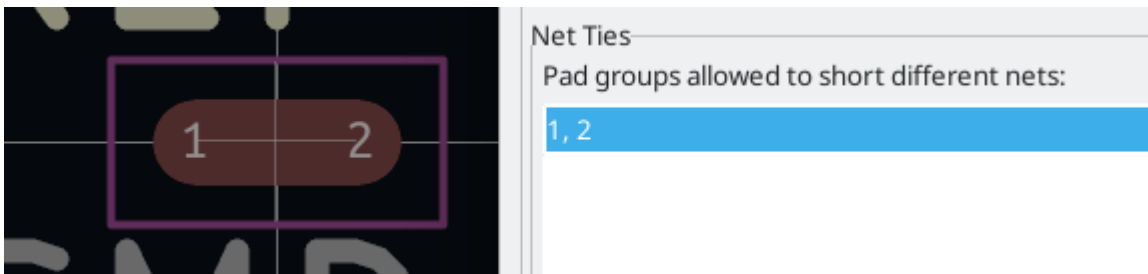

Net ties connect two or more nets in one contiguous region of copper. Each net in a net tie must have its own pad. Pads are not ordinarily allowed to short to other pads; to allow pads to be shorted in net ties, the shorting pads must be added to a **net tie group**. To create a net tie group, add the pad numbers of the shorting pads to the **Net Ties** table in the **Clearance Overrides and Settings** tab of the Footprint Properties dialog. For example, to allow pads 1 and 2 to short in a footprint, add a line to the table with the contents 1,2.

After creating a net tie group, the specified pads are allowed to be electrically shorted. Pads in net tie groups can be connected either by directly overlapping the pads or by adding a copper shape that overlaps both pads.

Footprints can contain multiple net tie groups. Each group can short two or more nets, but every group must remain electrically separate from other groups.

3D models

The **3D Models** tab allows you to attach external 3D model files to a footprint and view the footprint in three dimensions along with any attached models.

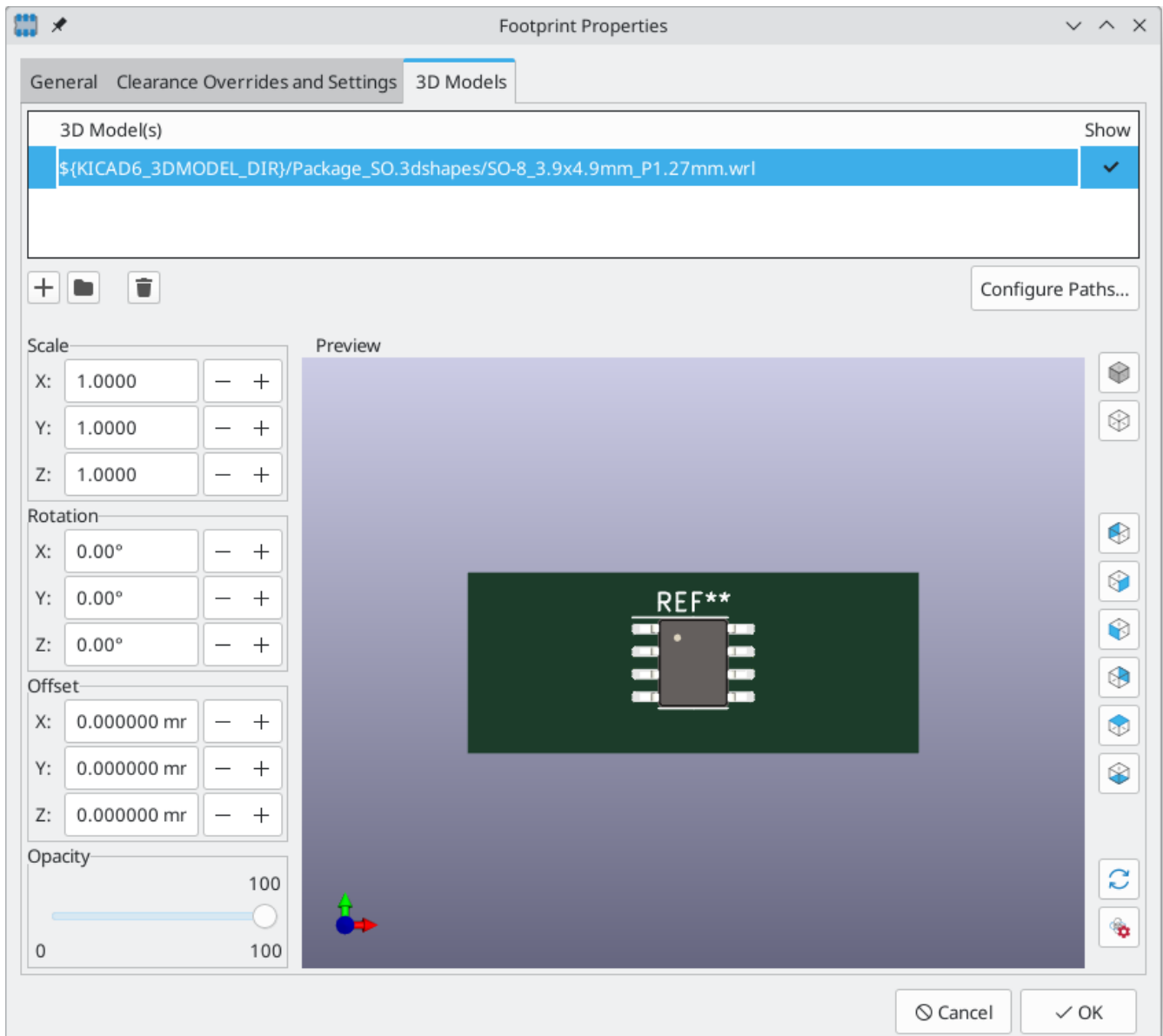

The main part of the window is a 3D preview of the footprint and any attached models. The buttons to the right of the preview let you enable or disable an orthographic projection (📐), show or hide the PCB model (📦), align the view to one of the six face-aligned perspectives (📐), and refresh the view (🔄). The bottom button (⚙️) lets you set the thickness of the PCB in the preview.

The top of the dialog lets you attach external models. Each added model will be shown in the footprint preview as well as in the full PCB 3D view when the footprint is added to a board. Footprint models can be in STEP, VRML, or **IDF** format. The models are specified as paths to the model files, which can contain **path variables** such as `{KIPRJMOD}` or `{KICAD8_3DMODEL_DIR}`. Click the **Configure Paths** button to configure path variables. If there is a problem loading a model file from the specified path, an icon in the leftmost column will indicate an error.

NOTE

KiCad will automatically resolve versioned path variables from older versions of KiCad to the value of the corresponding variable from the current KiCad version, as long as the old variable is not explicitly defined itself. For example, `${KICAD7_FOOTPRINT_DIR}` will automatically resolve to the value of `${KICAD8_FOOTPRINT_DIR}` if there is no `KICAD7_FOOTPRINT_DIR` variable defined.

NOTE

Many footprints in KiCad's standard library do not yet have model files created for them. However, these footprints may contain a path to a 3D model that does not yet exist, in anticipation of the 3D model being created in the future.



By default, models are added with their origin placed at the footprint's origin, with no offset, scaling, or rotation. Offset, scaling, and rotation can be applied to a model using the controls to the left of the preview canvas. The model's opacity can be adjusted using the **opacity** slider, and the model can be completely hidden by deselecting the **show** checkbox in the rightmost column of the model table.

Embedding files in footprints

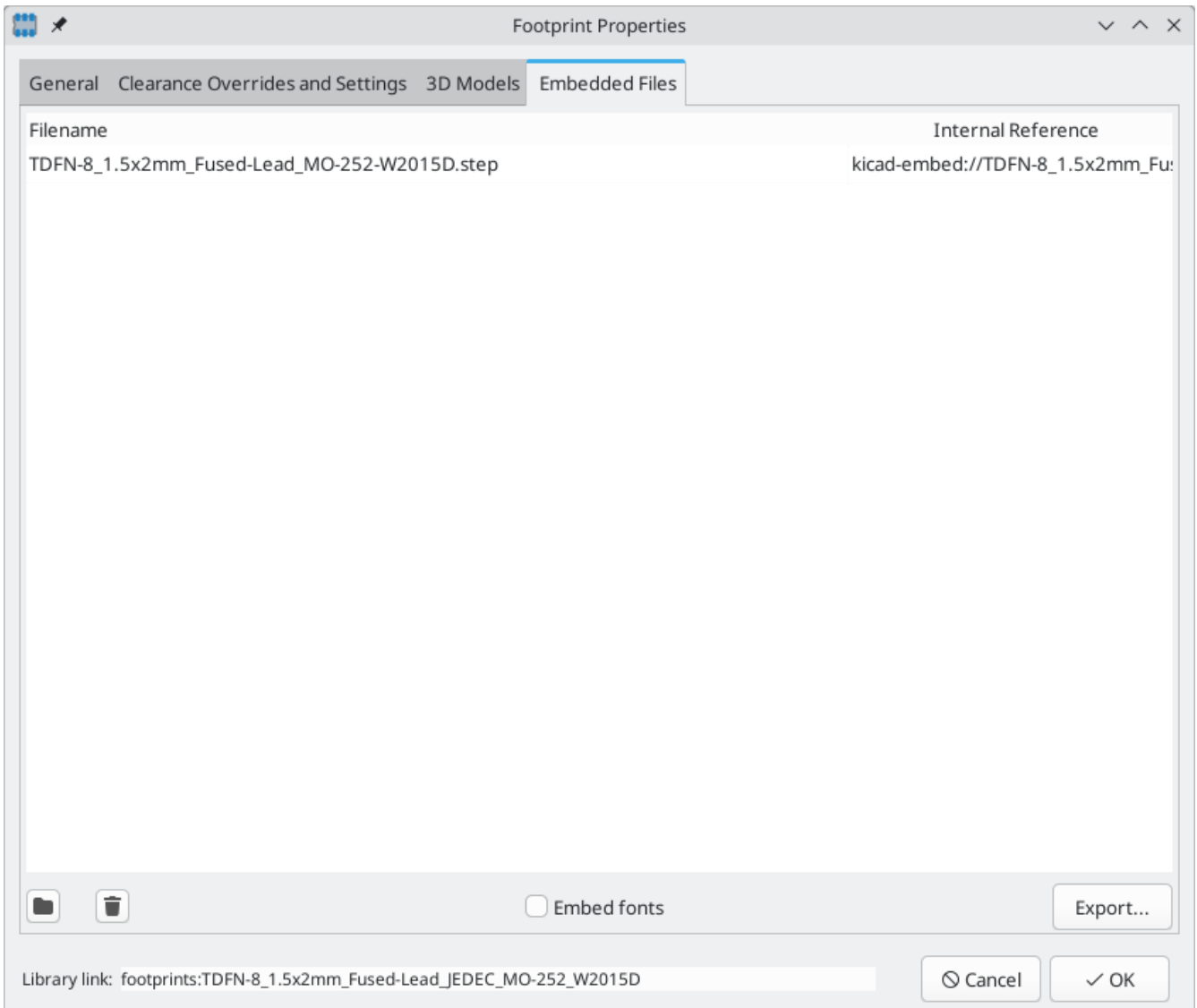
External files can be embedded within a footprint. Embedding a file stores a copy of the file inside the footprint. The footprint can then refer to the embedded copy of the file instead of the external file, which makes the footprint more portable as it doesn't rely on an external file. In footprints this is especially useful for embedding 3D models. Files embedded in a footprint are deduplicated when the footprint is added to a board: if a file is embedded in a footprint, and multiple instances of that footprint are added to the board, only one copy of the file will be embedded, and all of the footprint instances will refer to the same embedded file. Files embedded in a footprint cannot be referred to in the parent board. File embedding is explained in more detail in the [Board Setup documentation](#).



Footprint pads

Pads are added to a footprint by clicking the  button in the right toolbar, then clicking again in the desired location in the canvas. The tool will continue adding new pads each time you click on the canvas until you cancel the tool ().

New pads in SMD footprints are SMD by default, while new pads in Through Hole and Unspecified footprints will be through hole. Each new pad will have its pad number incremented by 1 relative to the previous pad number.

Pad properties

You can edit a pad after adding it by opening the pad's properties dialog (). These properties are also editable using the [Properties Manager](#).

General tab

The **General** tab of the pad properties dialog shows the physical properties of the pad, including its geometry, shape, and layer settings.

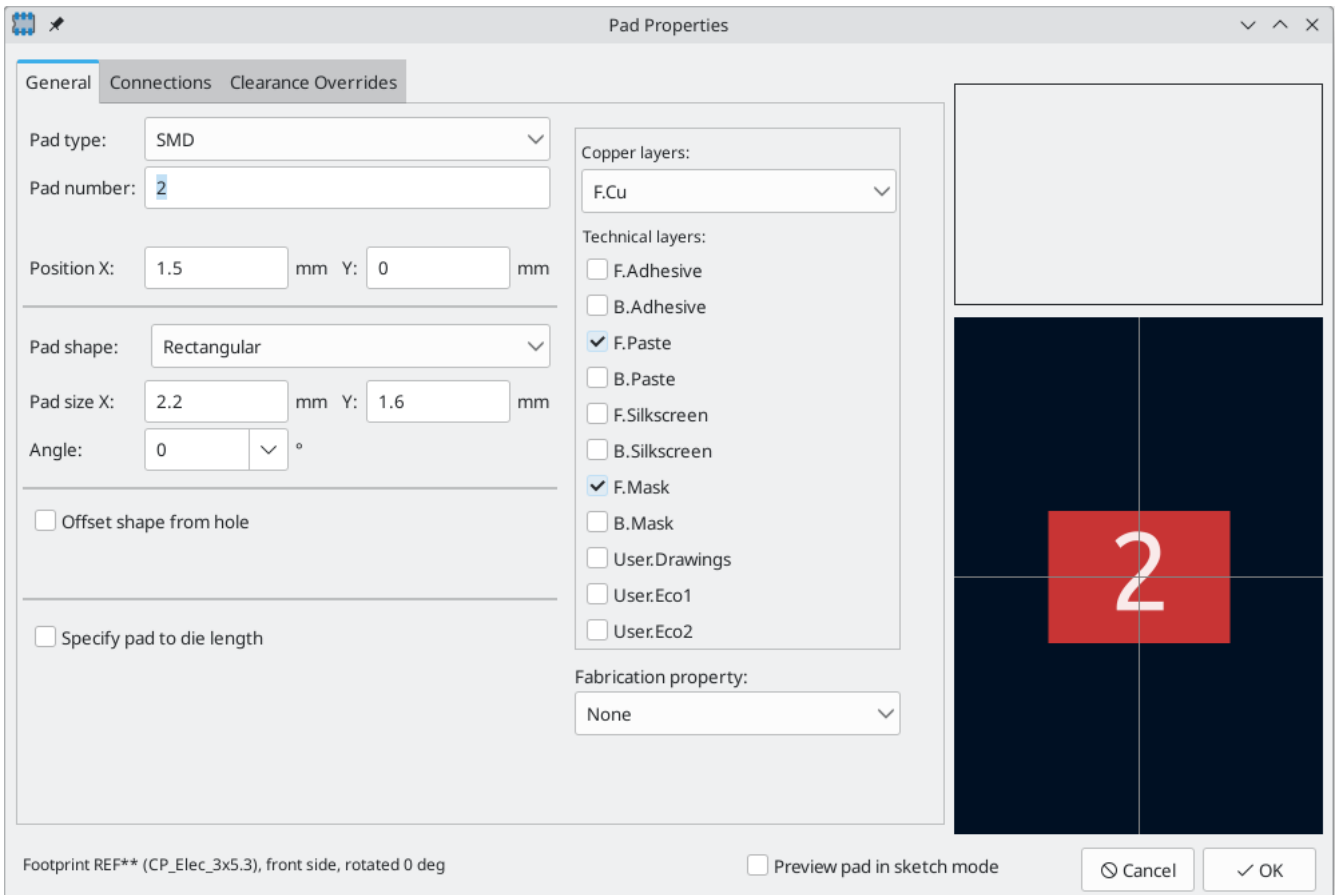

Pad type: this setting controls which features are enabled for the pad:

- **SMD** pads are electrically-connected and have no hole. In other words, they exist on a single copper layer.
- **Through-hole** pads are electrically-connected and have a plated hole. The hole exists on every layer, and the copper pad exists on multiple layers (see **Copper layers** setting below).
- **Edge Connector** pads are SMD pads that are allowed to overlap the board outline on the `Edge.Cuts` layer.
- **NPTH, Mechanical** pads are non-plated through holes that do not have an electrical connection.
- **SMD Aperture** pads are pads that have no hole and no electrical connection. These can be used to add specific designs to a technical layer, for example a paste or solder mask aperture.

铜层 设置控制哪些铜层将有一个与焊盘相关的形状。

For SMD pads, the options are `F.Cu` or `B.Cu`, controlling whether the pad sits on the front or the back of the board *relative to the footprint's location*. In other words, if a pad is set to exist on `B.Cu` in its properties, and the footprint is flipped to the back of the board, *that pad will now exist on `F.Cu`, because it also has been flipped*.

For through-hole pads, it is possible to remove the pad shape from copper layers where the pad is not electrically connected to other copper (tracks or filled zones). Setting the copper layers to **connected layers only** will remove the pad shape from any unconnected layers, and setting to `F.Cu`, `B.Cu`, **and connected layers** will remove the pad shape from any internal unconnected layers. This can be useful in dense board designs to increase the routable area on internal layers.

技术层 复选框控制哪些技术层会有一个与焊盘形状相同的孔径。默认情况下，焊盘在锡膏层和阻焊层上的孔径与铜层相匹配。

NOTE | 在当前版本的 KiCad 中，不支持在不同的铜层上定义不同的焊盘形状或尺寸。

The **Pad number** controls what the pad will be electrically connected to in the board. A pad has the same net connection as the pin with the same number in the corresponding schematic symbol.

Pad Position X and **Y** are the location of the center of the pad, relative to the footprint's origin.

Pad shape controls the basic shape of the pad. This can be **circular**, **oval**, **rectangular**, **trapezoidal**, **rounded rectangle**, **chamfered rectangle**, **chamfered with other corners rounded**, **custom (circular base)**, or **custom (rectangular base)**. Each pad shape has its own set of options; for example, rounded rectangles have settings for **pad size X** and **Y**, **angle**, **corner size**, and **corner radius**.

NOTE | The size of a pad can also be adjusted interactively in the canvas by dragging the editing handles at the pad corners.

Through-hole and NPTH pads have a hole in addition to the pad itself. The **hole shape** can be **circular** or **oval**, with corresponding size controls. By default the pad is centered on the hole, but the pad can be offset relative to the hole if the **offset shape from hole** option is enabled (circular pads cannot be offset from the hole).

Fabrication properties are primarily used as metadata in Gerber X2 fabrication output, where the fabrication property is included as an aperture attribute for each pad. Some properties also affect DRC. The following fabrication properties are available:

- **BGA pad** can only be applied to SMD pads, and only affects Gerber X2 output.
- **Fiducial, local to footprint** and **fiducial, global to board** only affect Gerber X2 output.
- **Test point** can only be applied to SMD or through hole pads, can only be applied to pads on outer layers, and only affects Gerber X2 output.
- Through hole pads with the **heatsink pad** property are allowed in SMD footprints (PTH pads without this property cause a DRC violation when they are used in SMD footprints). It also affects Gerber X2 output.
- Pads with the **castellated pad** property are allowed to intersect the board edge and still be routed (it is otherwise a DRC error for a pad to intersect the board edge, which makes routing impossible). It also affects Gerber X2 output.
- Through hole pads with the **mechanical** property can be used in SMD footprints without causing a DRC violation. This can be used for mounting pads or other mechanical through hole pads in surface mount footprints. This is similar to the **heatsink pad** property, but does not affect Gerber X2 output.
- **None** is for pads for which none of the other fabrication properties apply. It has no effect.

Specify pad to die length: This setting allows a length to be associated with this pad that will be added to the routed track length by the track length tuning tools and the Net Inspector. This can be used to specify internal bondwire lengths for more accurate length matching, or in other situations where the electrical length of a net is longer than the length of the routed tracks on the board.

Connections tab

The **Connections** tab contains settings for how pads connect to other objects, including settings for teardrops, zone connections, and thermal reliefs.

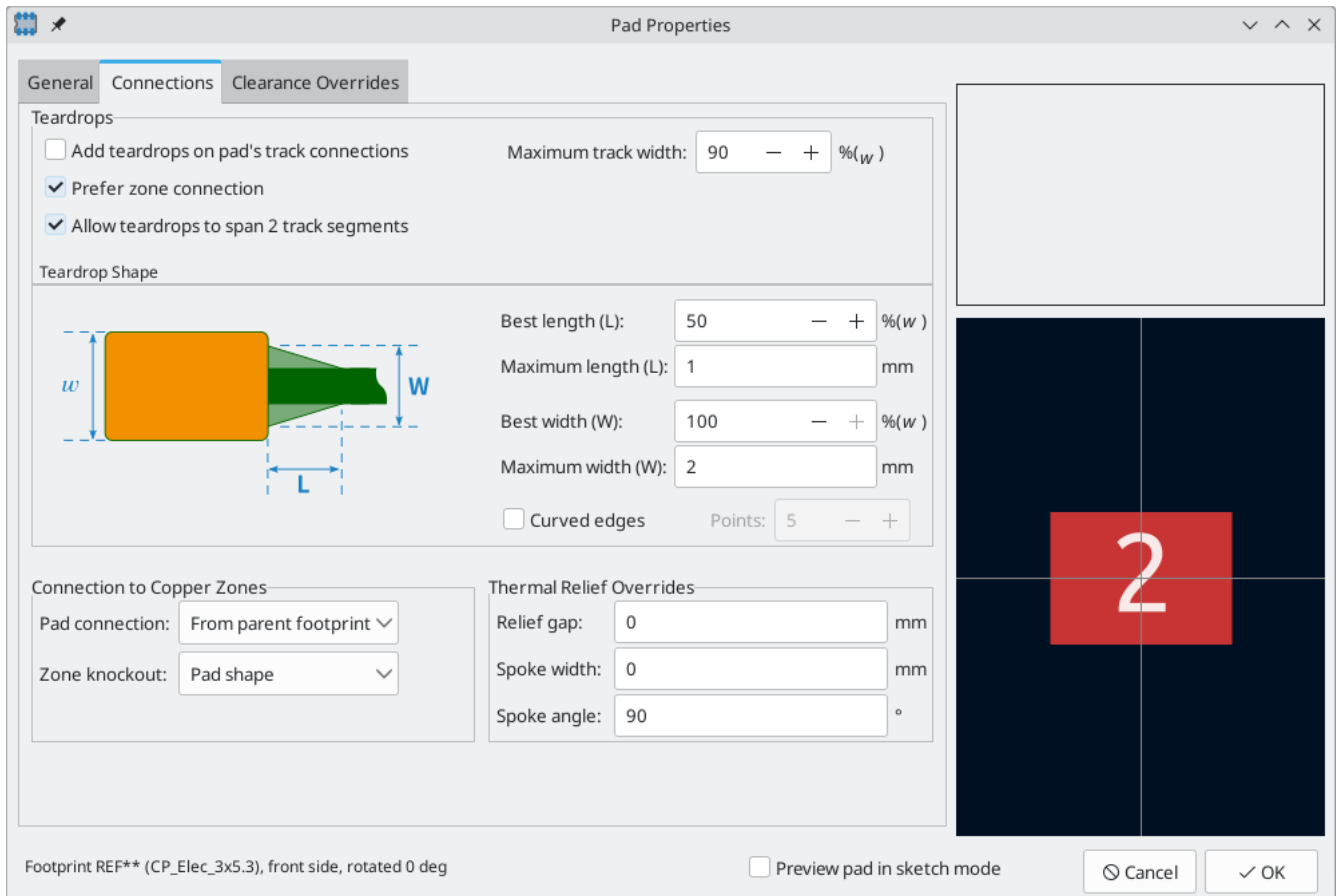

The Teardrops section contains settings controlling teardrop connections between tracks and the pad, if teardrops are used. Teardrop settings are explained in the [teardrop documentation](#).

Pad connection controls whether the pad will have a solid, thermal relief, or no connection to the zone. Like the other overrides, this one may be set for an individual pad or for an entire footprint. The default setting for this control is **From parent footprint**, and the default footprint setting is to use the connection mode specified in the zone properties.

Zone knockout controls the behavior of the zone filler when the pad uses a custom shape rather than one of the default shapes. This can be used to achieve different results when using thermal reliefs and custom pad shapes.

Relief gap controls the length of the thermal spokes, or the gap between the pad's shape and the filled copper area of the zone. This value is normally set to 0 which will cause the relief gap to be inherited from the connecting zone's settings.

Spoke width controls the width of the spokes generated when the zone connection mode is **Thermal Relief**. This value is normally set to 0 which will cause the spoke width to be inherited from the connecting zone's settings.

Clearance Overrides tab

The **Clearance Overrides** tab holds settings for pad-specific overrides to board clearance and mask/paste expansion.

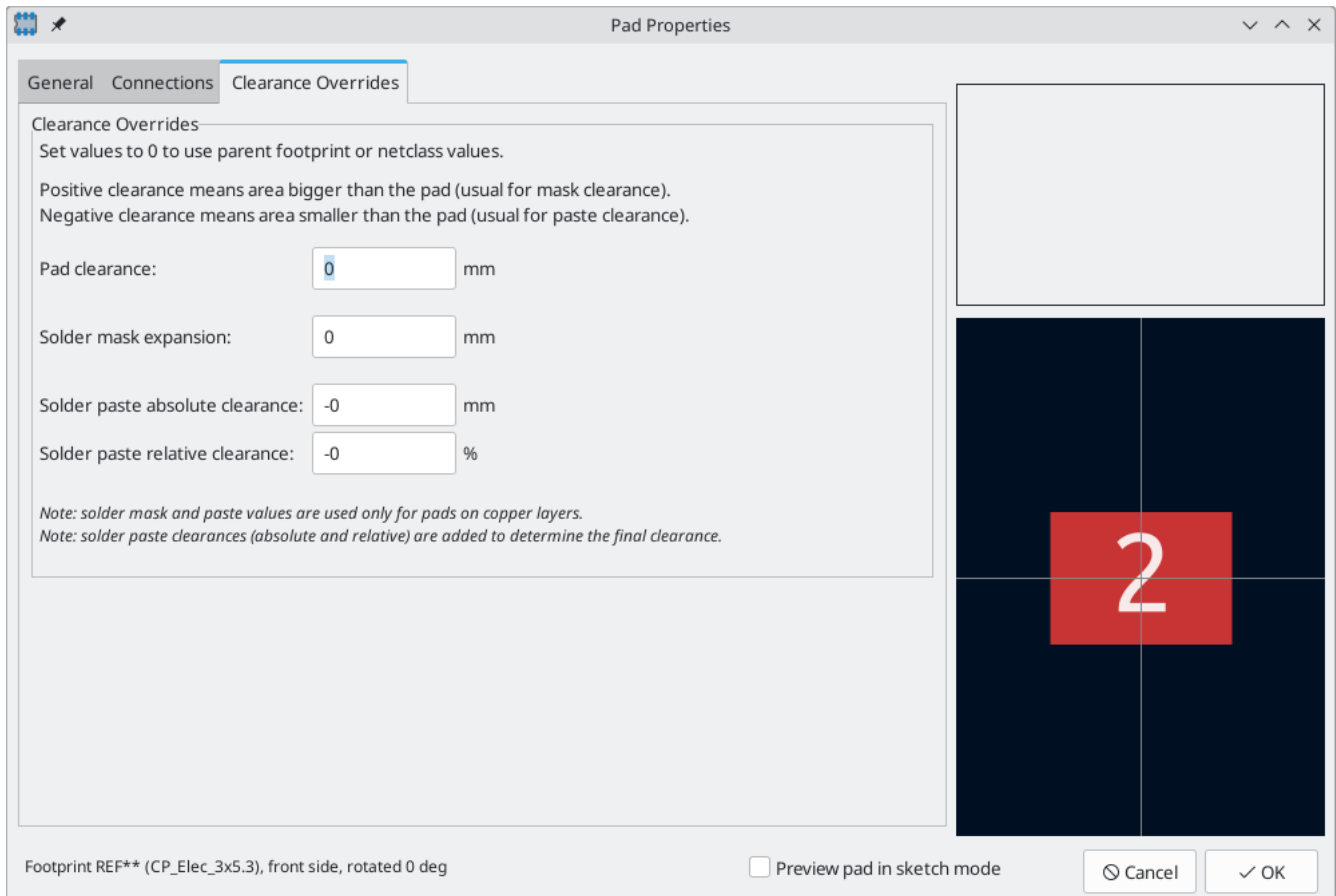

Pad clearance controls the minimum clearance between the pad and any copper shape (tracks, vias, pads, zones) on a different net. This value is normally set to 0 which will cause the pad clearance to be inherited from any clearance override set on the footprint, or the board's design rules and netclass rules if the footprint clearance is also set to 0.

The aperture appearing on any technical layer will have the same shape and size as the pad shape on the copper layer(s). In the PCB manufacturing process, the manufacturer will often change the relative size of mask and paste apertures relative to the copper pad size, but since this size change is specific to a manufacturing process, most manufacturers expect the design data to be provided with the apertures set to the same size as the copper pads. For specific situations where you need to oversize or undersize a technical layer aperture in the design data, you can use the settings here.

Solder mask expansion controls the size difference between the pad shape and the aperture shape on the F.Mask and B.Mask layers. A positive number means the solder mask aperture will be larger than the copper shape. This number is an inflation applied to all directions. For example, a value of 0.1mm here will cause the solder mask aperture to be inflated by 0.1mm, meaning that there will be an 0.1mm border on all sides of the pad and the solder mask opening will be 0.2mm wider than the pad when measured along a given axis.

Solder paste absolute clearance controls the size difference between the pad shape and the aperture shape on the F.Paste and B.Paste layers. Its behavior is otherwise identical to the behavior of the **solder mask expansion** setting.

Solder paste relative clearance allows setting a solder paste clearance value as a percentage of the pad size rather than an absolute distance value. If both relative and absolute clearances are specified, they are added together to determine the solder paste aperture size.

Working with multiple pads

When you place a new pad, the new pad's properties are copied from the **default pad properties**. Each time any pad is edited, the pad's updated properties are stored as the default pad properties, so that new pads will match the properties of the most recently edited pad.

You can directly edit the default pad properties by selecting **Edit** → **Default Pad Properties...**, or choose an existing pad to represent the default by right clicking the pad and choosing **Copy Pad Properties to Default**. New pads will use that pad's properties as their defaults until a new default is selected, either by editing another pad, editing the default pad properties, or manually copying a different pad's properties to the default.

There are several ways to update existing pads with the properties of other pads. You can apply the default pad properties to an explicit selection of pads by selecting the desired target pads, right clicking, and choosing **Paste Default Pad Properties to Selected** from the right click context menu. You can also update other pads with a selected pad's properties using **Push Default Pad Properties to Other Pads...**, also in the right click context menu.

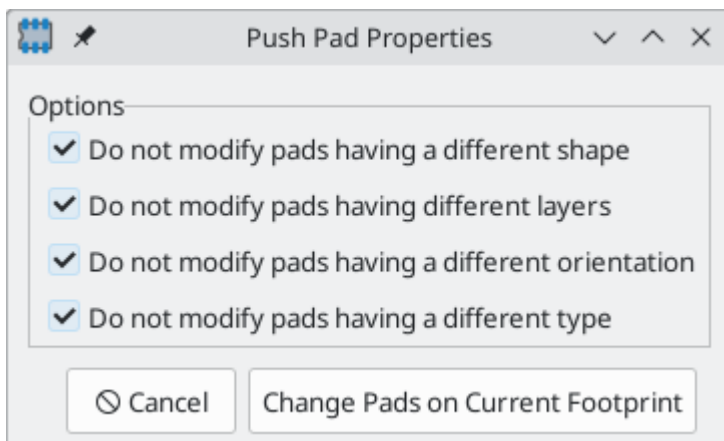

This tool has several options to filter which pads are targeted.

If **do not modify pads having a different shape** is selected, only pads with the exact same shape properties as the selected pad will be updated.

If **do not modify pads having different layers** is selected, only pads on the same layer(s) as the selected pad will be updated.

If **do not modify pads having a different orientation** is selected, only pads with the same orientation as the selected pad will be updated.

If **do not modify pads pads having a different type** is selected, only pads with the same pad type as the selected pad will be updated.

If no options are selected, all pads in the footprint will be updated.

You can create an array of pads from a source pad by right clicking the source pad and selecting **Create from Selection** → **Create Array...** (**Ctrl** + **T**). The basic functionality of this tool is described in the [PCB Editor](#)

[documentation](#). For pads, however, there are additional options for controlling pad numbering.

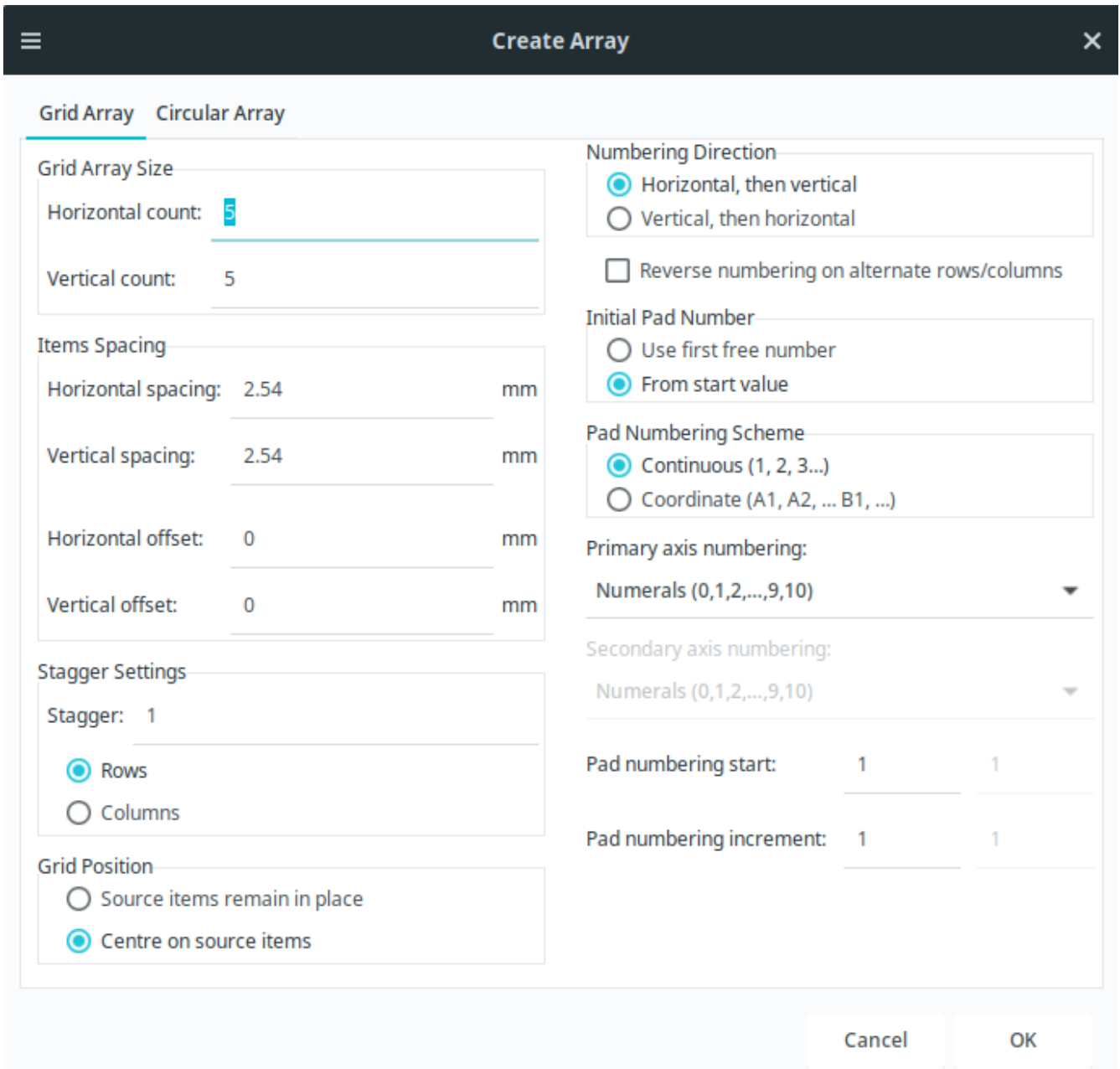

For grid arrays, you can select a numbering direction, either **horizontal, then vertical** or **vertical, then horizontal**. If **reverse numbering on alternate rows/columns** is selected, the direction of increasing pad numbers will alternate from one row/column to the next.

The initial pad number in the array can either be the first unused pad number in the footprint (**use first free number**) or the specified **pad numbering start** value. After the first number, the pad numbering can either be **continuous** (1, 2, 3, ...) or **coordinate** based, in other words, dependent on both the row and column (A1, A2, ..., B1, ...). In addition to the initial pad number (**pad numbering start**), you can specify a numbering step (**pad numbering skip**). For coordinate-based numbering, you can configure separate starting numbers and steps for each axis. You can select whether pad numbers use decimal digits (0-9), hexadecimal digits (0-F), the full alphabet, or the alphabet excepting certain ambiguous letters (I, O, S, Q, X, and Z).

Finally, you can quickly renumber existing pads using the Renumber Pads tool (**Edit** → **Renumber Pads...**).

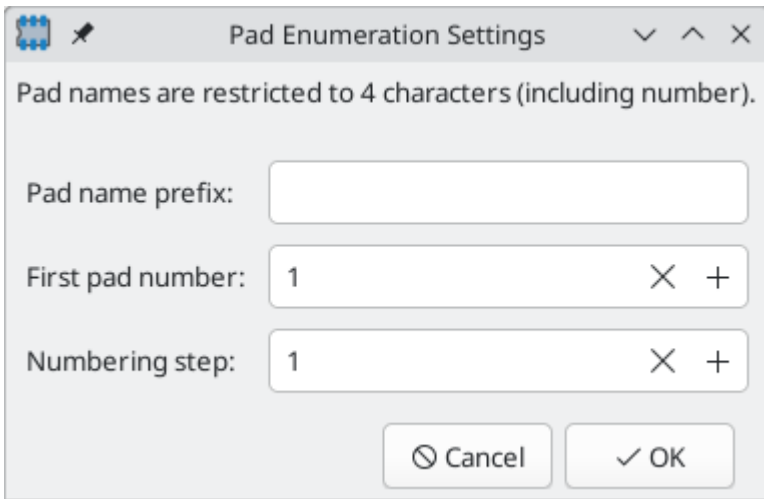

The tool has several options. Pads will be renumbered starting at the selected **first pad number**, and each subsequent pad will have its number incremented by the **numbering step**. You can also choose an optional **pad name prefix** which will be inserted before of the incrementing part of each pad number.

Once you click **OK**, you will be prompted to click on a pad, which will be assigned a new pad number based on the selected initial pad number and prefix. You can keep clicking on pads to assign them the next number in the sequence based on the selected numbering step. Double click on a pad to renumber that pad and end the sequence, or press **Esc** to discard the changes.

自定义焊盘形状

For some footprints, the built-in pad shapes (round, rectangular, etc.) may not be sufficient. In these cases you can construct custom pads with arbitrary shapes using **Pad Edit Mode**. This mode lets you combine a basic pad with graphic shapes to build a new pad out of the compound shape.

To build a custom pad, first add a regular pad using the pad tool ( button). This base pad will become the custom pad's anchor or snapping point, so be sure to place the pad in the exact location where you want tracks to attach to the pad. The shape and size of the pad do not matter, but the hole, if any, will remain in the final custom pad. In other words, a surface mount base pad will result in a surface mount custom pad, and a through hole base pad will result in a through hole custom pad. The custom pad's number will be inherited from the base pad.

Next, enter Pad Edit Mode by selecting the base pad, right-clicking, and selecting **Edit Pad as Graphic Shapes** (**Ctrl** + **E**). Add graphic shapes as appropriate to create the desired pad shape. Shapes touching the base pad will be unioned together with the base pad to create the final pad shape.

You can exit Pad Edit Mode by right-clicking and selecting **Finish Pad Edit**, or pressing **Ctrl** + **E** again. When you exit pad edit mode, all shapes that touch the base pad will be combined with the pad. For example, when editing a surface mount pad on **F.Cu**, any shapes that are on **F.Cu** and touch the base pad will become part of the custom pad. Any shapes that do not overlap the base pad, or that are on a different layer, will remain separate. If the base pad is a through hole pad, overlapping shapes on **F.Cu** will be combined in the custom pad. Because through hole pads have the same pad shape on all copper layers, this shape will become part of the custom pad on all copper layers, not just **F.Cu**. For convenience, Pad Edit Mode dims the color of other pads and all shapes that are not contiguous with the base pad so that you can see which shapes will be included in the custom pad and which will not.

Custom pads can only contain a single base pad. Any additional pads that touch the base pad or the contiguous graphics, whether they have the same or different pad numbers as the base pad, will remain separate pads after the shapes are combined into the custom pad.

NOTE

If you would like to add multiple anchors (snapping points) to a custom pad, you can add additional separate pads on top of the custom pad. Create the custom pad as normal, containing the first snapping point, then add additional pads with the same number and place them overlapping the custom pad in the desired snapping locations. They will remain distinct pads and will not be combined with the custom pad, but they will act as additional pad anchors and will be electrically connected to the custom pad.

To modify an existing custom pad, select it and enter Pad Edit Mode again. You can then continue to edit the component shapes to adjust the pad shape, or change the position of the base pad to adjust the pad anchor.

KiCad automatically chooses a size and location for showing the pad number over the pad. Particularly for unusually shaped pads, the automatically determined size and location may not be optimal. In these cases, you can manually specify a region in which KiCad should draw the pad number by adding a pad **number box** primitive. To add a number box, enter Pad Edit Mode and add a rectangular shape. In the Properties Manager for the rectangle, check the **Number Box** checkbox. The rectangle will then be shown as a wireframe, and when you exit Pad Edit Mode it will be used to draw the pad number.

In the board, KiCad will automatically add thermal spokes when connecting the pad to a zone. The thermal spoke settings are determined by the pad, footprint, and zone settings, and the thermal spokes by default connect to the pad anchor. You can override the default thermal spoke placement by adding **thermal relief templates** to the custom pad. To add a thermal relief template, enter Pad Edit Mode and add a line shape. In the Properties Manager for the line, check the **Thermal Relief Template** checkbox. In Pad Edit Mode, the line will then be shown as a wireframe, and it will not be shown outside of pad edit mode. If any thermal relief templates are present in the pad, KiCad will not automatically add additional spokes when filling zones; spokes will only be placed where there are thermal relief templates defined in the pad. Thermal relief templates only determine the spoke location: spoke width and relief gap are still defined in the pad, footprint, and/or zone properties, as normal.

Footprint graphics and text









Footprints can contain graphic shapes, text, and dimensions. These objects can be placed on nonphysical layers, like `F.Fab` or `User.Drawings`, or they can be placed on layers that will be part of the manufactured circuit board, such as `Edge.Cuts` or a silkscreen, soldermask, or copper layer. Objects on copper layers can make electrical connections.

Closed shapes on a footprint's `F.Courtyard` and `B.Courtyard` layers will form the footprint's front and back courtyard, respectively. A courtyard defines the physical extents of a footprint and limits where footprints are allowed to be placed in relation to other footprints. If a footprint's courtyard overlaps another footprint's courtyard, a DRC violation will be generated.

Shapes on a footprint's `Edge.Cuts` layer will correspond to board edges on any PCB that includes the footprint. Closed shapes will result in cutouts, while unclosed shapes will result in unclosed edges. Unclosed edges must be closed in the full board design.

The buttons on the right toolbar can be used to create:

- Lines (, default hotkey `Ctrl` + `Shift` + `L`)

- Arcs (, default hotkey **Ctrl** + **Shift** + **A**)
- Bezier curves (, default hotkey **Ctrl** + **Shift** + **B**)
- Rectangles ()
- Circles (, default hotkey **Ctrl** + **Shift** + **C**)
- Polygons (, default hotkey **Ctrl** + **Shift** + **P**)
- Text (**T**, default hotkey **Ctrl** + **Shift** + **T**)
- Textboxes ()
- Tables ()
- Dimensions (, of which several types are available)

NOTE

You can customize the default style of newly-created text and shape objects in **Preferences** → **Footprint Editor** → **Default Values**.

Graphical objects and their properties are described in more detail in the [PCB Editor documentation](#).

Bulk editing footprint text and graphics

Properties of text and graphics can be edited in bulk using the **Edit Text and Graphics Properties** dialog (**Edit** → **Edit Text & Graphic Properties...**).

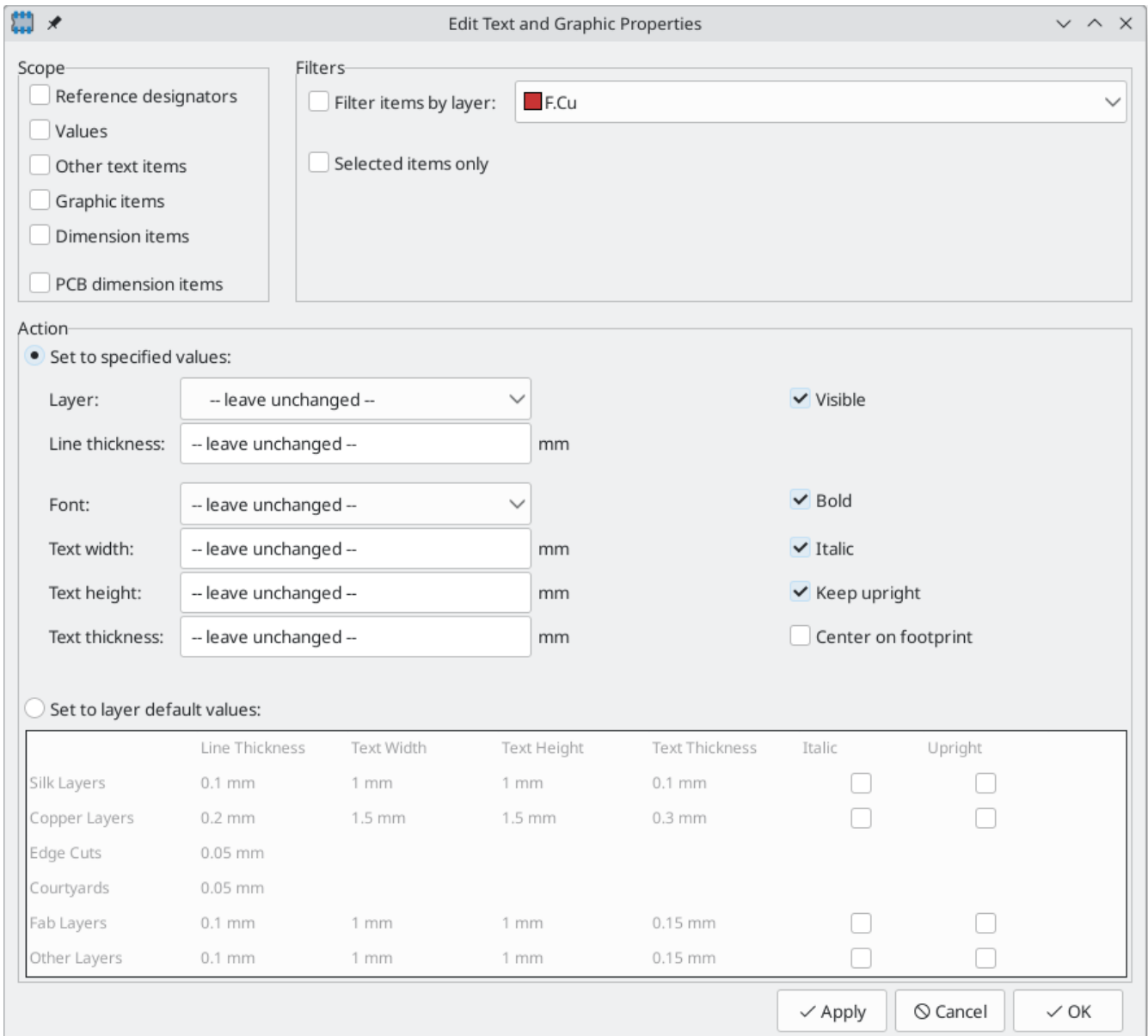

This dialog is described in more detail in the [PCB Editor documentation](#).

Cleaning up footprint graphics

There is a dedicated tool for performing common cleanup operations on graphics, which is run via **Tools** → **Cleanup Graphics...**

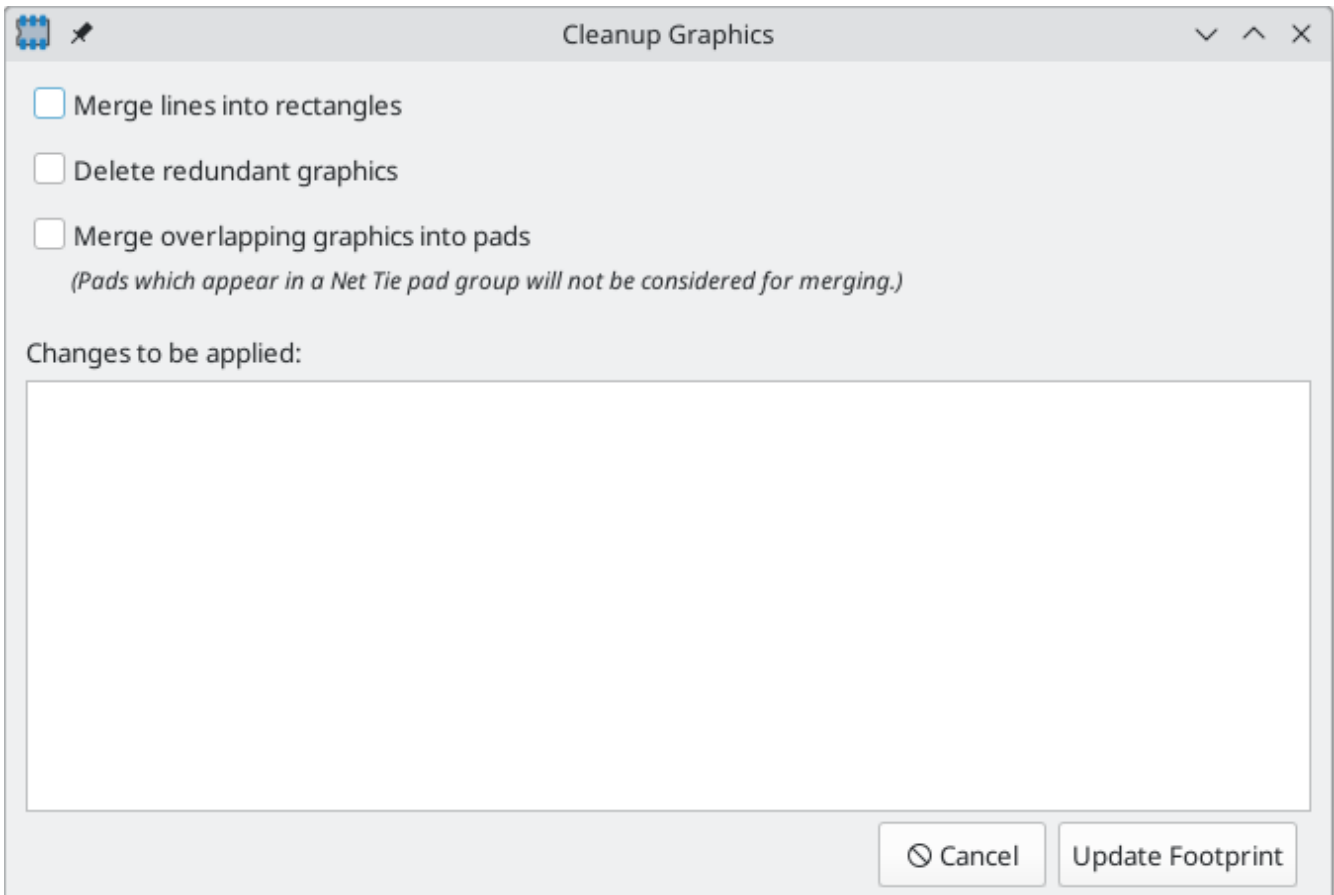

The following cleanup actions are available and will be performed when selected:

Merge lines into rectangles: combines individual graphic lines that together form a rectangle into a single rectangle shape object.

Delete redundant graphics: deletes graphics objects that are duplicated or degenerate.

Merge overlapping graphics into pads: merges graphic copper shapes that overlap pads into a [custom pad](#).

Any changes that will be applied to the footprint are displayed at the bottom of the dialog. They are not applied until you press the **Update Footprint** button.

Rule areas

Rule areas, also known as keepouts, are footprint regions that can have specific DRC rules defined for them. Some basic rules are available that will raise DRC errors if certain types of objects are within the bounds of the rule area, but rule areas can also be used together with [custom DRC rules](#) to define complex DRC behavior that only applies within the rule area. A rule area in a footprint takes effect when the footprint is added to the board.

You can add a rule area by clicking the  button on the right toolbar (**Ctrl** + **Shift** + **K**). Click on the canvas to place the first corner, which will show the Rule Area Properties dialog. After configuring the rule area appropriately, press **OK** to continue placing corners of the rule area. The rule area shape can be an arbitrary polygon; click on the starting corner or double click to finish placing the rule area.

Rule areas are described in more detail in the [PCB editor](#) documentation.

Reference images

Just like in the PCB Editor, you can use reference images in the Footprint Editor to assist with your footprint designs. Footprint reference images are only shown in the Footprint Editor: they are not shown in the PCB Editor when a footprint is added to a board, and they do not appear in any fabrication outputs.

To add a reference image, use the  button on the right toolbar and select the desired reference image file.

Reference images are described in more detail in the [PCB Editor documentation](#).

封装向导

KiCad provides a set of footprint wizards that can be used to create some common kinds of footprints based on a set of parameters. Wizards for the following types of footprints are provided:

- BGA packages
- QFN packages
- QFP packages
- SOIC, MSOP, SSOP, TSSOP, etc. packages
- SIP and DIP packages
- ZIP packages
- ZOIC packages
- FPC connectors
- Micromatch SMD connectors
- Circular pad arrays
- Touch sliders
- Mutual capacitance touch buttons
- USS-39 barcodes
- QR codes

To create a footprint using a footprint wizard, click the  button and choose a footprint type from the list that appears.

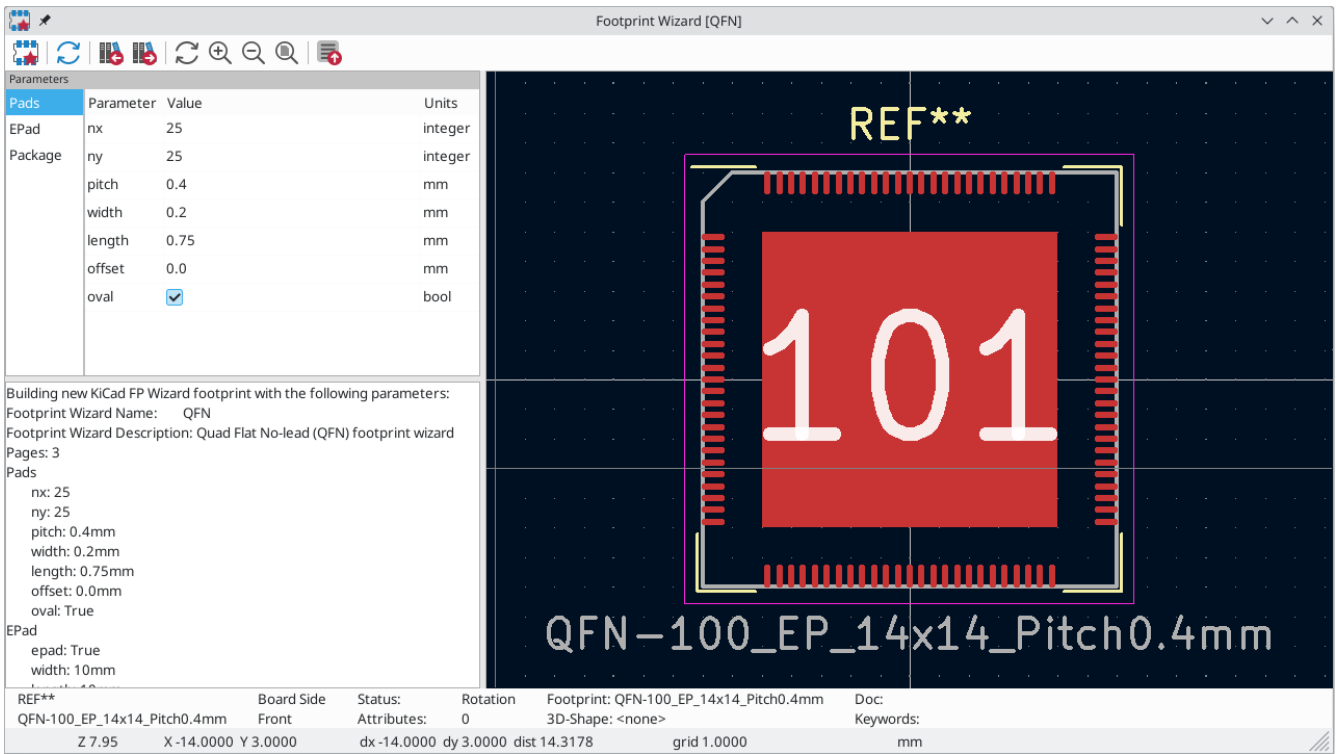

In the window that appears, fill out the parameters as appropriate. When the parameters are correctly filled out, press the  button to transfer the generated footprint back into the footprint editor. Then you can make additional manual modifications and save the footprint as normal.

In addition to the set of footprint wizards that KiCad provides, you can also create your own. For more information about creating new footprint wizards, see the [Scripting section](#) of the Advanced Topics chapter.

Checking footprints

The Footprint Editor can check for common issues in your footprints. Run the footprint checker using the  button in the top toolbar.

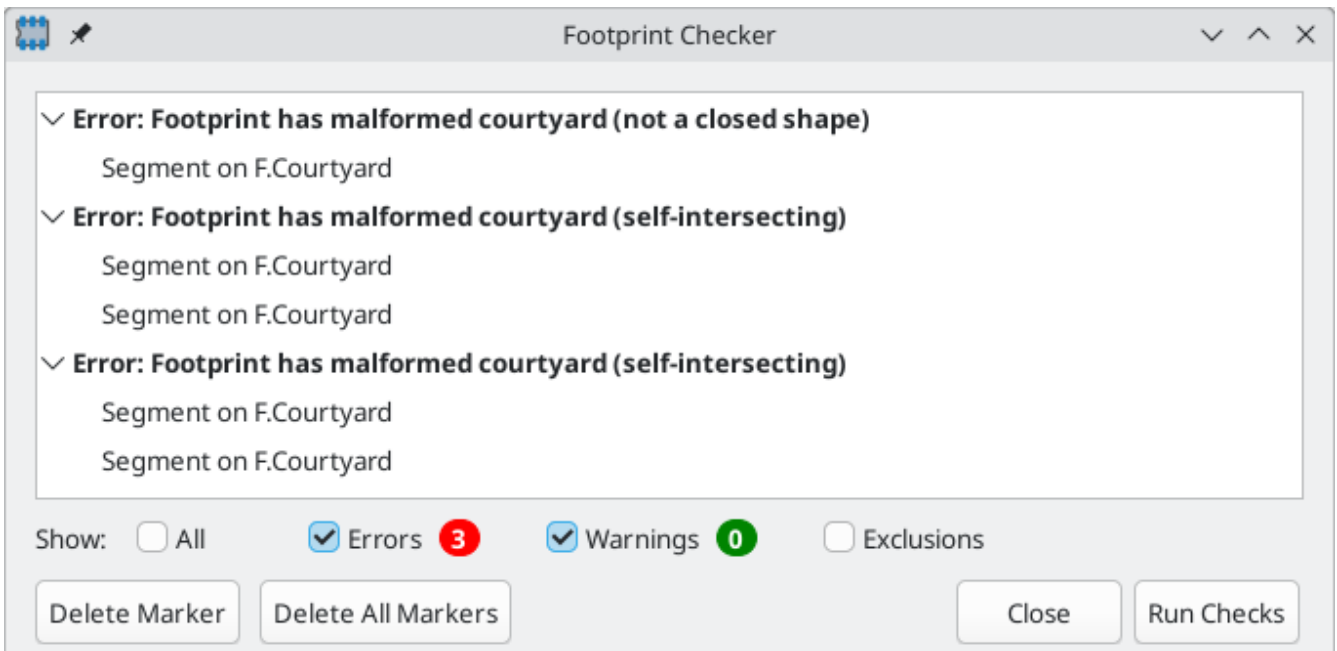

Any footprint issues that are detected are listed in the dialog and displayed with arrow indicators in the editing canvas. Clicking on an issue in the dialog will focus on the issue in the canvas.

The footprint checker checks for:

- Malformed or missing courtyards
- Pads that don't match the footprint's type: footprints without any through hole pads should be set to the surface mount footprint type
- Through hole pads without a hole
- Plated through hole pads not on any copper layers
- Plated through hole pads without a copper annulus
- Surface mount pads on both the front and back
- Surface mount pads with mismatched copper and paste/mask layers (front copper and back paste/mask, or vice versa)
- Pads that short to other pads outside of net tie groups
- Nonexistent pads in net tie groups
- Pads in that appear in multiple net tie groups

Browsing footprint libraries





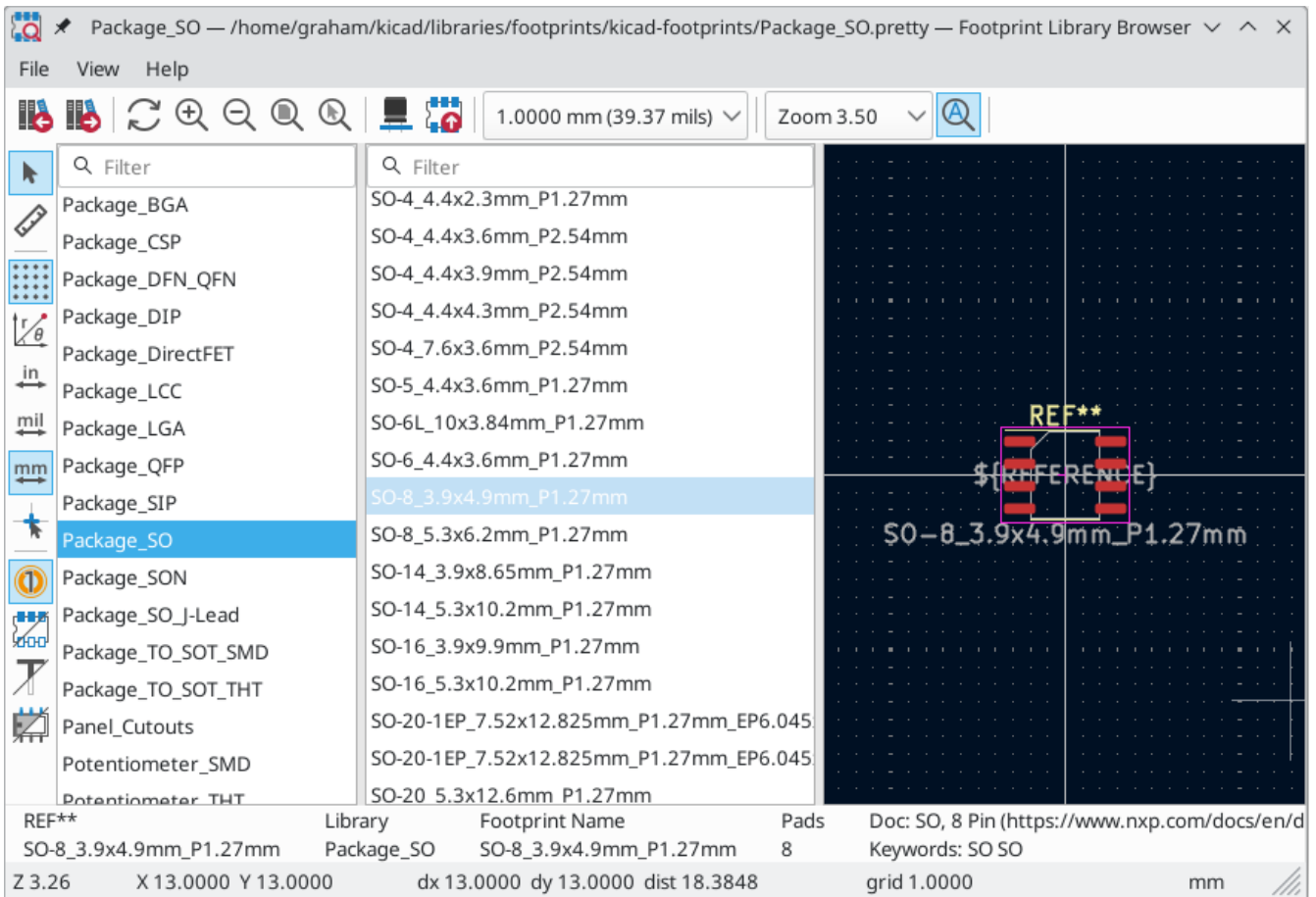

The Footprint Library Browser allows you to quickly examine the contents of footprint libraries. The Footprint Library Viewer can be accessed by clicking  icon on the main Board Editor toolbar or with **View → Footprint Library Browser**.

To examine the contents of a library, select a library from the list in the left hand pane. All footprints in the selected library will appear in the second pane. Select a footprint name to view the footprint.















Double clicking the name of a footprint or using the  button adds the footprint to the board.

The top toolbar contains the following commands:

	Select previous footprint in library.
	Select next footprint in library.
	Zoom tools.
	Open footprint in 3D Viewer.
	Add the footprint to the board.
	Automatically zoom to fit each opened footprint.

The left toolbar contains the following commands:

	Selection tool (the default tool).
	Interactively measure the distance between two points.
	Turn grid display on/off.
	Switch between polar and Cartesian coordinate display in the status bar.
  	Display/entry of coordinates and dimensions in inches, mils, or millimeters.
	Switch between full-screen and small editing cursor (crosshairs).
	Show or hide pad numbers.
	Switch display of pads between filled and outline mode.
	Switch display of text between filled and outline mode.
	Switch display of graphic items between filled and outline mode.

高级主题

配置和自定义

KiCad PCB 编辑器有多种偏好设置，可通过偏好设置对话框进行配置。和 KiCad 的所有部分一样，PCB 编辑器的偏好设置存储在用户配置目录中，并且在 KiCad 的小版本之间是独立的，以允许多个版本的偏好设置分别运行。

偏好设置对话框的第一部分（通用、鼠标和触摸板以及快捷键）是所有 KiCad 程序共享的。这些部分在 KiCad 手册中的“常规偏好设置”部分有详细描述。

显示选项

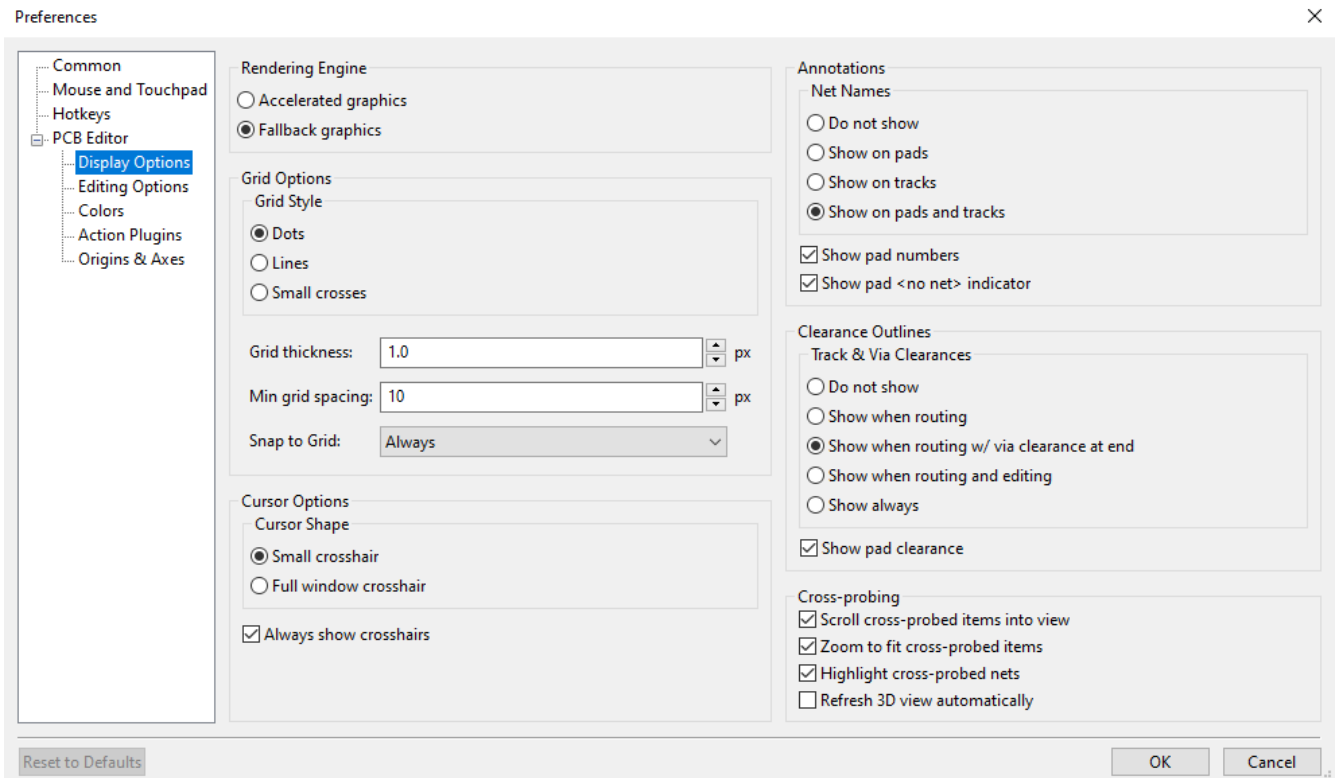

Rendering Engine: Controls if Accelerated graphics or Fallback graphics are used.

Grid style: Controls how the alignment grid is drawn.

Grid thickness: Controls how thick grid lines or dots are drawn.

Min grid spacing: Controls the minimum distance, in pixels, between two grid lines. Grid lines that violate this minimum spacing will not be drawn, regardless of the current grid setting.

Snap to grid: Controls when drawing and editing operations will be snapped to coordinates on the active grid. "Always" will enable snapping even when the grid is hidden; "When grid shown" will enable snapping only when the grid is visible.

NOTE

按住 **Ctrl** 可以暂时禁用网格捕捉。

Cursor shape: Controls whether the editing cursor is drawn as a small crosshair or a full-screen crosshair (a set of lines covering the entire drawing canvas). The editing cursor shows where the next drawing or editing

action will occur and will be snapped to a grid location if snapping is enabled.

Always show crosshairs: Controls whether the editing cursor is shown all the time or only when an editing or drawing tool is active.

Net names: Controls whether or not net name labels are drawn on copper objects. These labels are guides for editing only and do not appear in fabrication outputs.

Show pad numbers: Controls whether or not pad number labels are drawn on footprint pads.

Show pad <no net> indicator: Controls whether or not pads with no net are indicated with a special marker.

Track clearance: Controls whether or not clearance outlines around tracks and vias are shown. Clearance outlines are shown as thin shapes around objects that indicate the minimum clearance to other objects, as defined by constraints and design rules.

Show pad clearance: Controls whether or not clearance outlines around pads are shown.

Center view on cross-probed items: When the Schematic and PCB Editors are both running, controls whether clicking a component or pin in Eeschema will center the PCB Editor view on the corresponding footprint or pad.

Zoom to fit cross-probed items: Controls whether the view will be zoomed to show a cross-probed footprint or pad.

Highlight cross-probed nets: Controls whether or not nets highlighted in Eeschema will be highlighted in the PCB Editor when the highlight tool is activated in both tools.

编辑选项

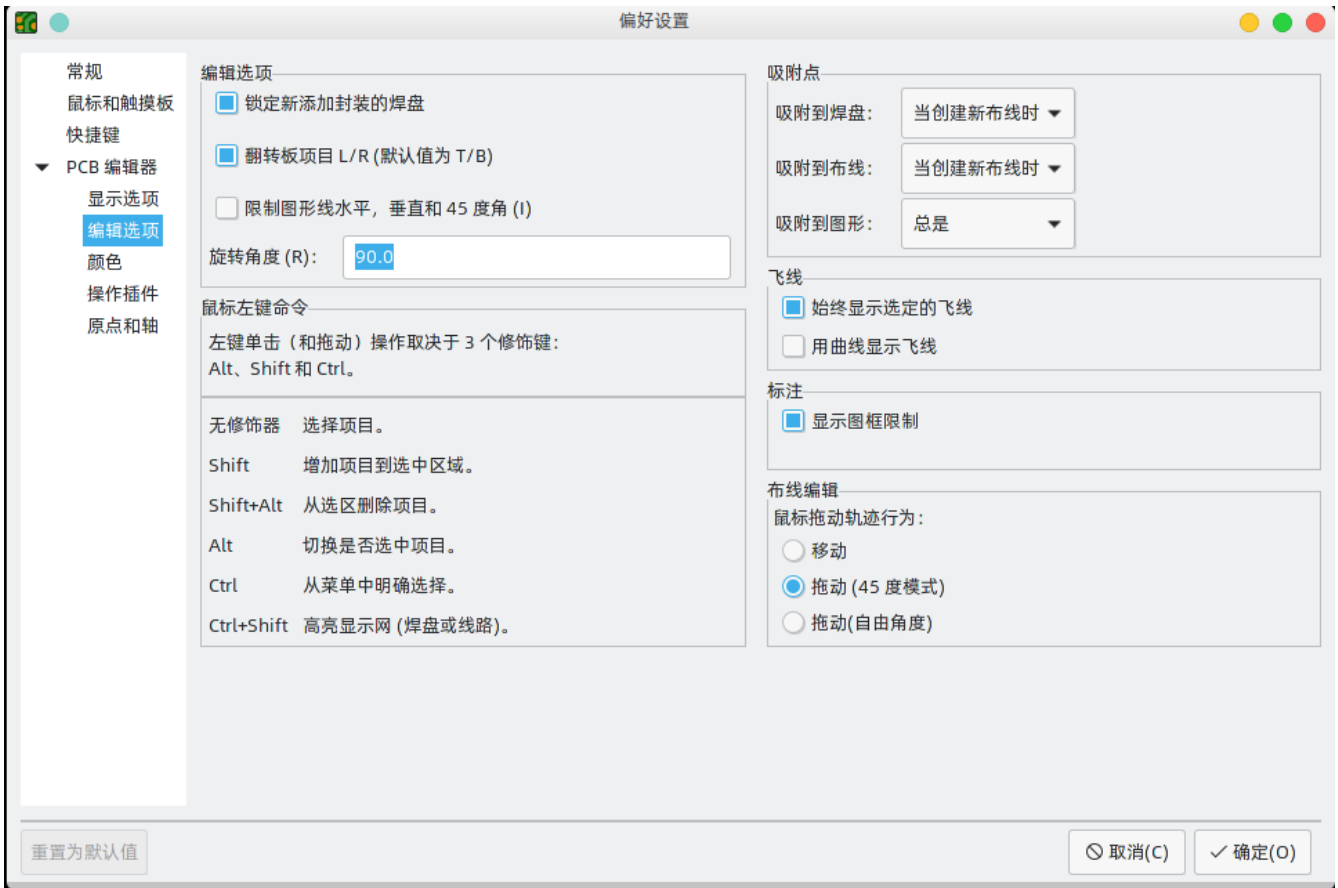

Flip board items L/R: Controls the direction board items will be flipped when moving them between the top and bottom layers. When checked, items are flipped Left-to-Right (about the Vertical axis); when unchecked, items are flipped Top-to-Bottom (about the Horizontal axis).

Step for rotate commands: Controls how far the selected object(s) will be rotated each time the Rotate command is used.

Allow free pads: Controls whether or not the pads of footprints can be unlocked and edited or moved separately from the footprint.

Magnetic points: This section controls object snapping, also called magnetic points. Object snapping takes precedence over grid snapping when it is enabled. Object snapping only works to objects on the active layer. Hold **Shift** to temporarily disable object snapping.

Snap to pads: Controls when the editing cursor will snap to pad origins.

Snap to tracks: Controls when the editing cursor will snap to track segment endpoints.

Snap to graphics: Controls when the editing cursor will snap to graphic shape points.

Always show selected ratsnest: When enabled, the ratsnest for a selected footprint will always be shown even if the global ratsnest is hidden.

Show ratsnest with curved lines: Controls whether ratsnest lines are drawn straight or curved.

Mouse drag track behavior: Controls the action that will occur when you drag a track segment with the mouse: "Move" will move the track segment independent of any others. "Drag (45 degree mode)" will invoke the push-and-shove router to drag the track, respecting design rules and keeping other track segments attached. "Drag (free angle)" will move the nearest corner of the track segment, highlighting collisions with other objects but not moving them out of the way.

Limit actions to 45 degrees from start Controls whether lines drawn with the graphic drawing tools can take on any angle. Note that this only affects drawing new lines: lines can be edited to take on any angle.

Show page limits: Controls whether or not the page boundary is drawn as a rectangle.

Refill zones after Zone Properties dialog: Controls whether or not zones are automatically refilled after editing the properties of any zone. This may be disabled on complicated designs or slower computers to improve responsiveness.

颜色

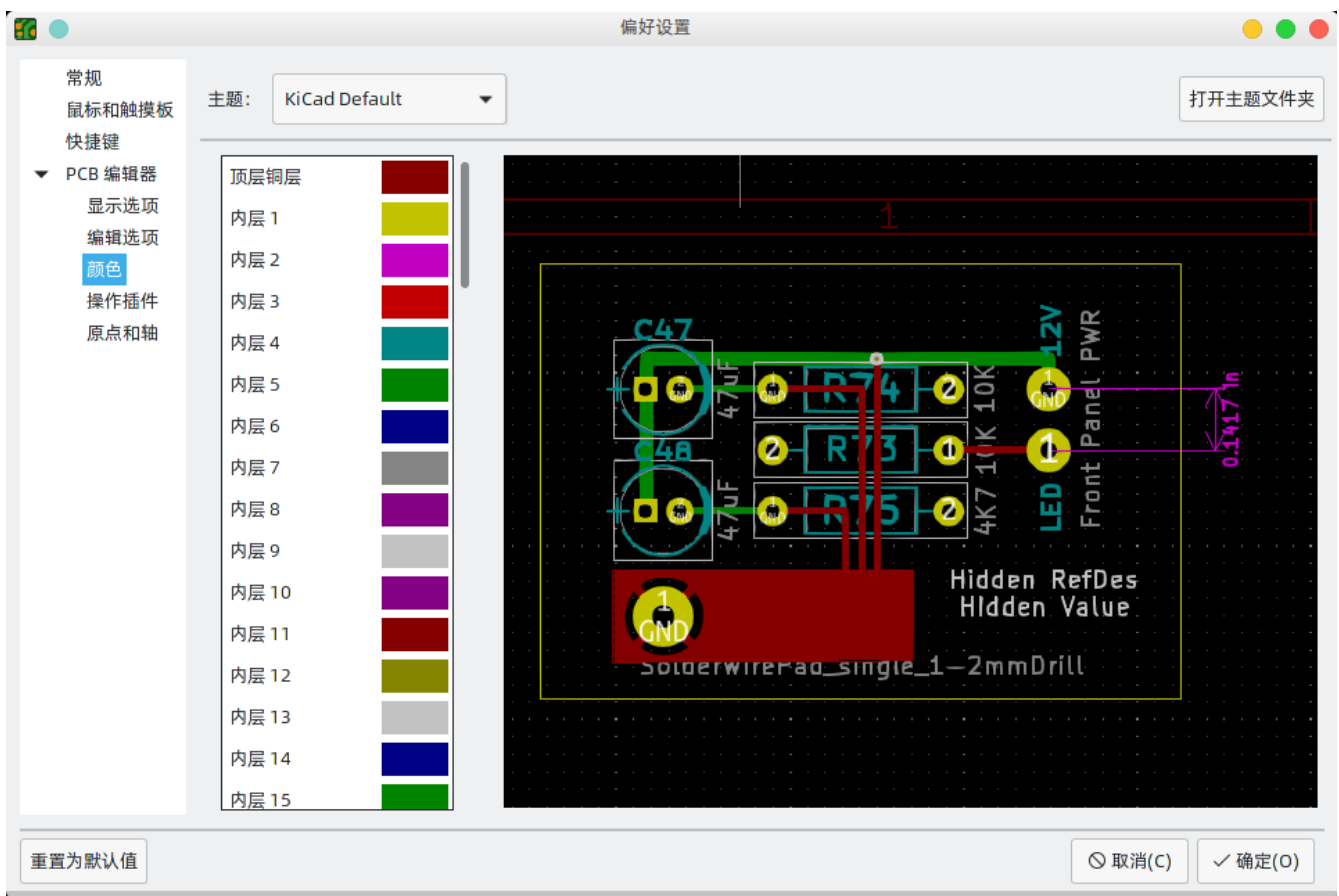

KiCad supports switching between different color themes to match your preferences. Kicad 8.0 comes with two built-in color themes: "KiCad Default" is a new theme designed to have good contrast and balance for most cases and is the default for new installations. "KiCad Classic" is the default theme from KiCad 5.1 and earlier versions. Neither of these built-in themes can be modified, but you can create new themes to customize the look of KiCad as well as install themes made by other users.

颜色主题存储在位于 KiCad 配置目录的 `Colors` 子目录中的 JSON 文件中。“打开主题文件夹”按钮将在您的系统文件管理器中打开此位置，使您可以轻松地管理已安装的主题。要安装新主题，请将其放在此文件夹中，然后重新启动 KiCad。如果文件是有效的颜色主题文件，则从颜色主题下拉列表中可以看到新主题。

要创建一个新的颜色主题，从颜色主题的下拉列表中选择“新主题...”。为你的主题输入一个名称，然后开始编辑颜色。新主题中的颜色将从你创建新主题之前选择的任何主题中复制。

要更改颜色，请双击或中键单击列表中的色样。“重置为默认值”按钮会将该颜色重置为“KiCad 默认”颜色主题中的相应条目。

颜色主题会自动保存；当您关闭“偏好设置”对话框时，所有更改都会立即反映出来。对话框右侧的窗口显示所选主题外观的预览。

操作插件

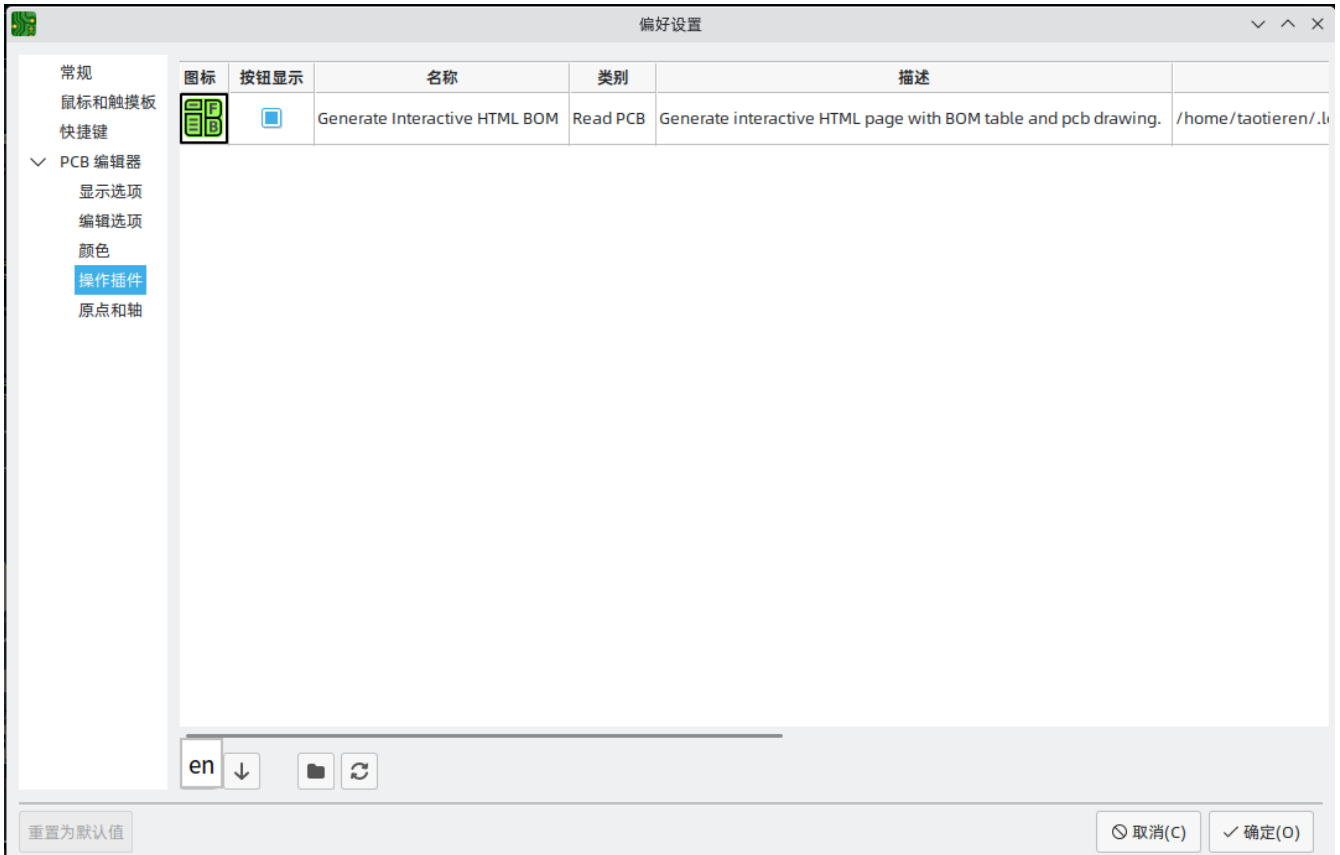

KiCad PCB 编辑器支持用 Python 编写的插件，对正在编辑的电路板进行操作。这些插件可以使用内置的“插件和内容管理器”来安装（详见 KiCad 章节），或者将插件文件放在用户的插件目录中。详见下面的脚本部分。

每个被检测到的插件都会在这个偏好设置上显示一排。插件可以在“PCB 编辑器”的顶部工具栏上显示一个按钮。如果一个插件的“显示按钮”控制没有被选中，它仍然可以从“工具”>“外部插件”菜单中访问。

列表底部的箭头控制允许改变插件在工具栏和菜单中的显示顺序。文件夹按钮将启动一个文件资源管理器到插件文件夹，以使安装新的插件更容易。刷新按钮将扫描插件文件夹中的任何新的或删除的插件，并更新列表。

原点和轴



Display origin: Determines which coordinate origin is used for coordinate display in the editing canvas. The page origin is fixed at the corner of the page. The drill/place file origin and the grid origin can be moved by the user.

X axis: Controls whether X-coordinates increase to the right or to the left.

Y axis: Controls whether Y-coordinates increase upwards or downwards.

文本变量

KiCad支持文本变量，允许你用定义的文本字符串替换变量名称。这种替换发生在变量名称在 `${VARIABLENAME}` 的变量替换语法内的任何地方。

You can define project text variables in the [schematic](#) or [board setup](#) dialogs. Project text variables are defined for the whole project, so a project text variable defined in the Schematic Editor can also be used in the Board Editor.

There are also a number of built-in system text variables. System text variables may be available in some contexts and not others. The following variables can be used in PCB text, footprint text, footprint fields, and drawing sheet fields. There are also a number of [variables that can be used in the Schematic Editor](#).

Variable name	Description
COMMENT1 - COMMENT9	Contents of drawing sheet's Comment<n> field.

Variable name	Description
COMPANY	Contents of drawing sheet's Company field.
CURRENT_DATE	Today's date, in ISO format.
FILENAME	Filename of the board, with a file extension.
FILEPATH	Full file path of the board, with a file extension.
ISSUE_DATE	Contents of drawing sheet's Issue Date field.
KICAD_VERSION	Current version of KiCad. This variable is only available in drawing sheet fields.
LAYER	Layer of the object. In footprint fields, this is the layer of the parent footprint. In drawing sheet fields, this resolves to the plotted layer.
PAPER	Current sheet's paper size. This variable is only available in drawing sheet fields.
PROJECTNAME	Project name, without a file extension.
REVISION	Contents of drawing sheet's Revision field.
TITLE	Contents of drawing sheet's Title field.
<variablename>	Contents of project text variable <variablename> .
<fieldname>	<p>Contents of footprint field <fieldname>. Fields can only be accessed from within their parent object, so footprint fields can be accessed from other fields or text within the footprint.</p> <p>Both built-in footprint fields and user-defined fields from the corresponding symbol are available. Built-in footprint fields use all uppercase letters: for example, to access a footprint's value, use <code>\${VALUE}</code>.</p> <p>Built-in footprint fields are <code>FOOTPRINT_LIBRARY</code>, <code>FOOTPRINT_NAME</code>, <code>LAYER</code>, <code>NET_CLASS(<pad_number>)</code>, <code>NET_NAME(<pad_number>)</code>, <code>PIN_NAME(<pad_number>)</code>, <code>REFERENCE</code>, <code>SHORT_NET_NAME(<pad_number>)</code>, <code>VALUE</code> .</p>
<refdes>: <fieldname>	<p>Contents of field <fieldname> in footprint <refdes> .</p> <p>Both built-in footprint fields and user-defined fields from the corresponding symbol are available. Built-in footprint fields use all uppercase letters: for example, to access the value of <code>U1</code>, use <code>\${U1:VALUE}</code> .</p> <p>Built-in footprint fields are <code>FOOTPRINT_LIBRARY</code>, <code>FOOTPRINT_NAME</code>, <code>LAYER</code>, <code>NET_CLASS(<pad_number>)</code>, <code>NET_NAME(<pad_number>)</code>, <code>PIN_NAME(<pad_number>)</code>, <code>REFERENCE</code>, <code>SHORT_NET_NAME(<pad_number>)</code>, <code>VALUE</code> .</p>

Variable name	Description
DRC_WARNING <warningname>	Generates a DRC warning named <warningname>. This behaves the same as DRC_ERROR, except a warning is generated rather than an error.

Custom design rules

KiCad's custom design rule system allows creating design rules that are more specific than the generic rules available in the Constraints page of the Board Setup dialog. Custom design rules have many applications, but in general they are used to apply certain rules to a portion of the board, such as a specific net or net class, a specific area, or a specific footprint.

自定义设计规则存储在一个扩展名为 `kicad_dra` 的单独文件中。当您开始向项目添加自定义规则时，会自动创建此文件。如果您在项目中使用自定义规则，请在备份或提交到版本控制系统时，确保将 `kicad_dra` 文件与 `kicad_pcb` 和 `kicad_pro` 文件一起保存。

NOTE

`kicad_dra` 文件由 KiCad 自动管理，不应使用外部文本编辑器进行编辑。始终使用电路板设置对话框的自定义规则页面编辑自定义设计规则。

自定义规则编辑器

自定义规则编辑器位于电路板设置对话框中，它提供了一个用于输入自定义规则的文本编辑器，一个语法检查器将测试你的自定义规则并指出任何错误，还有一个语法帮助对话框，其中包含了对自定义规则语言的快速参考和一些规则示例。

The custom rules editor also provides context-sensitive autocomplete to suggest valid keywords and properties. The autocomplete suggestion menu appears automatically, but it can also be opened manually by pressing `Ctrl + Space`.

在编辑自定义规则后，最好使用 **检查规则语法** 按钮，确保没有语法错误。自定义规则中的任何错误将阻止设计规则检查器的运行。

自定义规则语法

The custom design rule language is based on s-expressions and allows you to create design constraints that are not possible with the built-in constraints. Each design rule generally contains a **condition** defining what objects to match and a **constraint** defining the rule to be applied to the matched objects.

The language uses parentheses ((and)) to define clauses of related keywords and values. Parentheses must always be matched: for every (there must be a matching). Inside a clause, keywords and values are separated by whitespace (spaces, tabs, and newlines). By convention, a single space is used, but any number of whitespace characters between keywords and values is acceptable. In places where text strings are valid, strings without any whitespace may be quoted with " or ', or unquoted. Strings that contain whitespace must always be quoted. Newlines cannot be used within a quoted string. Where nested quotes are required, a single level of nesting is possible by using " for the outer quote character and ' for the inner (or vice versa). Newlines between clauses are not required, but are typically used in examples for clarity.

In the syntax descriptions below, items in <angle brackets> represent keywords or values that must be present and items in [square brackets] represent keywords or values that are optional or only sometimes required.

header should read:

```
(version 1)
```

在版本头之后，您可以输入任何数量的规则。规则的评估顺序是相反的，也就是说，文件中的最后一条规则首先被检查。一旦为一个给定的被测对象找到一个匹配的规则，将不再检查其他规则。在实践中，这意味着更具体的规则应该在文件的后面，以便它们在更通用的规则之前被评估。

例如，如果您创建一条规则来限制 HV 网络的布线与任何其他网络的布线之间的最小间距，然后又创建第二条规则来限制特定规则区域内所有对象的最小间距，请确保第一条规则在自定义规则文件中的出现时间比第二条规则晚，否则，如果 HV 网络中的布线落在规则区域内，可能会有错误的间距。

Each rule must have a name and one or more `constraint` clauses. The name can be any string and is used to refer to the rule in DRC reports. The `constraint` defines the behavior of the rule. Rules may also have a `condition` clause that determines which objects should have the rule applied, an optional `layer` clause which specifies which board layers the rule applies to, and an optional `severity` clause which specifies the severity of the resulting DRC violation.

```
(rule <name>
  [(severity <severity>)]
  [(layer <layer_name>)]
  [(condition <expression>)]
  (constraint <constraint_type> [constraint_arguments]))
```

The custom rules file may also include comments to describe rules. Comments are denoted by any line that begins with the `#` character (not including whitespace). You can press `Ctrl` + `/` to comment or uncomment lines automatically.

```
# Clearance for 400V nets to anything else
(rule HV
  (condition "A.hasNetclass('HV')")
  (constraint clearance (min 1.5mm)))
```

图层子句

层 (`layer`) 子句确定规则将对哪些层起作用。虽然对象层可以在下面介绍的 `约束 (constraint)` 子句中进行测试，但是使用 `层 (layer)` 子句效率更高。

The value in the `layer` clause can be any board layer name, or the shortcut keywords `outer` to match the front and back copper layers (`F.Cu` and `B.Cu`) and `inner` to match any internal copper layers.

如果省略 `层 (layer)` 子句，则该规则将适用于所有层。

下面是一些示例：

```
# Do not allow footprints on back layer (no condition clause means this rule always
applies)
(rule "Top side footprints only"
  (layer B.Cu)
  (constraint disallow footprint))

# This rule does the same thing, but is less efficient
(rule "Top side footprints only"
  (condition "A.Layer == 'B.Cu'")
  (constraint disallow footprint))

# Larger clearance on outer layers (inner layer clearance set by board minimum clearance)
(rule "clearance_outer"
  (layer outer)
  (constraint clearance (min 0.25mm)))
```

Severity Clause

The `severity` clause sets the DRC violation severity whenever the rule is violated.

Possible values are `error`, `warning`, `ignore`, and `exclusion`. Ignored rules are not observed by the interactive router and violations are not shown in the DRC dialog. However, ignored rules are evaluated for matching and therefore can still override earlier rules. Errors, warnings, and excluded rules are all observed by the interactive router, and violations are displayed in the DRC dialog when the appropriate filters are selected.

WARNING

Setting a rule's severity to `ignore` does not disable the rule; only the effects of the rule are disabled. The rule is still evaluated and can still override previous rules.

Condition Clauses

The `condition` clause determines which objects which objects the rule applies to. If a rule has a condition clause, the rule will apply to any objects that match the condition. If a rule does not have any condition clauses, it will apply unconditionally.

规则 **条件** 是一个包含在文本字符串中的表达式（因此通常用引号包围，以便允许留出空白，使之更清晰）。该表达式是针对设计规则检查器正在测试的每一对对象进行评估的。例如，当检查铜对象之间的间隙时，每个网络上的每个铜对象（布线段、焊盘、通孔等）都要与其他网络上的其他铜对象进行检查。如果存在一个自定义规则，其表达式与两个给定的铜对象相匹配，并且约束条件定义了铜的间隙，那么这个自定义规则可以用来确定这两个对象之间所需的间隙。

被测对象在表达式语言中称为 `A` 和 `B`。这两个对象的顺序并不重要，因为设计规则检查器将测试这两种可能的顺序。例如，您可以编写一条规则，假设 `A` 为布线，`B` 为过孔。有一些表达式函数可以同时测试这两个对象；这些表达式函数使用 `AB` 作为对象名。

The expression in a condition must resolve to a boolean value (true or false). If the expression resolves to true, the rule is applied to the given objects.

每个被测对象都有可以比较的 **属性**，以及可以执行特定测试的 **函数**。属性和函数的使用语法分别为 `<object>.<property>` 和 `<object>.<function>([arguments])`。译者注：`<对象>.<属性>` 和 `<对象>.<函数>([参数])`。

NOTE

当你在文本编辑器中输入 <对象>。（A.、B. 或 AB.）时，将打开一个自动完成的列表，其中包含所有可以使用的对象属性。

The object properties and functions are compared using **boolean** and **relational operators** to result in a boolean expression. The following operators are supported:

==	Equal to
!=	Not equal to
>, >=	Greater than, greater than or equal to
<, <=	Less than, less than or equal to
&&	And
	Or
!	Not (unary)

For example, `A.NetName == 'VDD'` will apply to any objects that are part of the "VDD" net and `A.NetName != B.NetName` will apply to any objects that have different net names. Parentheses can be used to clarify the order of operations in complex expressions but they are not required. All the boolean operators have the same precedence and are evaluated in order from left to right.

To test a boolean property, evaluate the property itself, without comparing it to a boolean literal like `true` or `false` (which don't exist in the DRC rules language). For example, to test if a footprint's boolean `Do_not_populate` property is set, the boolean expression `A.Do_not_populate` by itself is sufficient. It will resolve to a true value if the footprint's DNP attribute is set, and a false value otherwise. To check if a boolean is false, use the `!` operator (unary not): `!A.Do_not_populate` will resolve to a true value if the DNP attribute is unset, and a false value otherwise.

有些属性表示物理测量，比如尺寸、角度、长度、位置等等。在这些属性上，**单位后缀**可以在自定义规则语言中使用，以指定使用什么单位。如果没有使用单位后缀，属性的内部表示将被使用（距离为纳米，大多数角度为度）。支持以下后缀：

mm	毫米
mil, th	千分之一英寸 (mils)
in, "	英寸
deg	度
rad	弧度

NOTE

自定义设计规则中使用的单位独立于 PCB 编辑器中的显示单位。

Numeric conditions can use simple math expressions, for example (condition "A.Hole_Size_X == 1.0mm + 0.1mm").

Constraint Clauses

The `constraint` clause of the rule defines the behavior of the rule on the objects that are matched by the condition. Each constraint clause has a **constraint type** and one or more arguments that set the behavior of the constraint. A single rule may have multiple constraint clauses, in order to set multiple constraints (for example, `clearance` and `track_width`) for objects that match the same rule conditions.

许多约束条件的参数指定了一个物理测量或数量。这些约束条件支持最小值、最优值和最大值说明（缩写为“min/opt/max”）。**最小**和**最大**值用于设计规则检查：如果实际值小于约束条件中的最小值或大于最大值，将产生一个DRC错误。**最优**值仅用于某些约束，并通知KiCad默认使用的“最优”值。例如，最优的`diff_pair_gap`是由布线器在放置新的差分对时使用的。如果后来修改了差分对，使得差分对之间的间隙与最佳值不同，只要间隙在最小值和最大值之间（如果这些值被指定），就不会产生错误。在所有接受最小/最大/最优值的情况下，可以指定全部的最小值、最优值和最大值。

最小/最优/最大值被指定为 `(min<value>)`，`(opt<value>)`，和 `(max<value>)`。例如，布线宽度约束可以写成 `(constraint track_width (min 0.5mm) (opt 0.5mm) (max 1.0mm))`，如果只约束最小宽度，可以简单写成 `(constraint track_width (min 0.5mm))`。

Numeric constraint values can use simple math expressions, for example `(constraint clearance (min 0.5mm + 0.1mm))`.

Constraint type	Argument type	Description
<code>annular_width</code>	min/opt/max	Checks the width of annular rings on vias and pads.
<code>assertion</code>	boolean expression	Checks that the boolean expression is true. If the expression is false, a DRC error will be created. The expression can use any of the properties listed in the Object Properties section.
<code>clearance</code>	min	Specifies the electrical clearance between copper objects of different nets. (See <code>physical_clearance</code> if you wish to specify clearance between objects regardless of net.) To allow copper objects to overlap (collide), create a <code>clearance</code> constraint with the <code>min</code> value less than zero (for example, <code>-1</code>).
<code>creepage</code>	min	Specifies the creepage between copper objects of different nets.
<code>connection_width</code>	min	Checks the width of connections between pads and zones. An error will be generated for each pad connection that is narrower than the min value.

Constraint type	Argument type	Description
courtyard_clearance	min	<p>Checks the clearance between footprint courtyards and generates an error if any two courtyards are closer than the <code>min</code> distance. If a footprint does not have a courtyard shape, no errors will be generated from this constraint.</p> <p>To allow courtyard objects to overlap (collide), create a <code>courtyard_clearance</code> constraint with the <code>min</code> value less than zero (for example, <code>-1</code>).</p>
diff_pair_gap	min/opt/max	<p>Sets the gap between parallel tracks in a differential pair. The <code>opt</code> setting is used by the interactive router for placing new differential pairs. An error will be generated if the spacing between tracks in a differential pair is outside of the <code>min</code> and <code>max</code> settings. Differential pair gap is not tested on non-parallel portions of a differential pair (for example, the fanout from a component).</p>
diff_pair_uncoupled	max	<p>Checks the distance that a differential pair track is routed uncoupled from the other polarity track in the pair (for example, where the pair fans out from a component, or becomes uncoupled to pass around another object such as a via). An error will be generated for each differential pair with an uncoupled distance that is greater than the <code>max</code> value. Differential pair tracks are considered uncoupled if they are not parallel or if they are outside the range set by a <code>diff_pair_gap</code> constraint.</p>
disallow	track via micro_via buried_via pad zone text graphic hole footprint	<p>Specify one or more object types to disallow, separated by spaces. For example, <code>(constraint disallow track)</code> or <code>(constraint disallow track via pad)</code>. If an object of this type matches the rule condition, a DRC error will be created. This constraint is essentially the same as a keepout rule area, but can be used to create more specific keepout restrictions.</p>
edge_clearance	min/opt/max	<p>Checks the clearance between objects and the board edge.</p> <p>This can also be thought of as the "milling tolerance" as the board edge will include all graphical items on the Edge.Cuts layer as well as any oval pad holes. (See <code>physical_hole_clearance</code> for the drilling tolerance.)</p> <p>To allow objects to overlap (collide) with the board edge, create an <code>edge_clearance</code> constraint with the <code>min</code> value less than zero (for example, <code>-1</code>).</p>

Constraint type	Argument type	Description
hole_size	min/max	Checks the size (diameter) of a drilled hole in a pad or via. For oval holes, the smaller (minor) diameter will be tested against the <code>min</code> value (if specified) and the larger (major) diameter will be tested against the <code>max</code> value (if specified).
hole_to_hole	min	<p>Checks the clearance between mechanically-drilled holes in pads and vias. The clearance is measured between the diameters of the holes, not between their centers.</p> <p>This constraint is solely for the protection of drill bits. The clearance between laser-drilled (microvias) and other non-mechanically-drilled holes is not checked, nor is the clearance between milled (oval-shaped) and other non-mechanically-drilled holes.</p>
length	min/max	Checks the total routed length for the nets that match the rule condition and generates an error for each net that is below the <code>min</code> value (if specified) or above the <code>max</code> value (if specified) of the constraint. This constraint also sets a target length that is used by the length tuning tool for any nets that match the rule condition.
min_resolved_spokes	0 1 2 3 4	Checks the total number of connections (spokes) to a pad. An error will be raised for each pad that has fewer than the specified number of spokes.
physical_clearance	min	<p>Checks the clearance between two objects on a given layer (including non-copper layers).</p> <p>While this can perform more general-purpose checks than <code>clearance</code>, it is much slower. Use <code>clearance</code> where possible.</p>

Constraint type	Argument type	Description
physical_hole_clearance	min	<p>Checks the clearance between a drilled hole in a pad or via and another object, regardless of net. The clearance is measured from the diameter of the hole, not its center.</p> <p>This can also be thought of as the "drilling tolerance" as it only includes round holes (see <code>edge_clearance</code> for the milling tolerance).</p>
silk_clearance	min/opt/max	<p>Checks the clearance between objects on silkscreen layers and other objects.</p> <p>To allow silkscreen objects to overlap (collide) with other objects, create a <code>silk_clearance</code> constraint with the <code>min</code> value less than zero (for example, <code>-1</code>).</p>
skew	min/opt/max/within_diff_pairs	<p>Checks the total skew for the nets that match the rule condition, that is, the difference between the length of each net and the longest net that is matched by the rule. If the difference between the longest net and the length of any one net is above the constraint <code>max</code> value, an error will be generated. This constraint also sets a target skew that is used by the skew tuning tool for any nets that match the rule condition. The target skew is the <code>opt</code> value, if specified, or the <code>min</code> value if not. If neither <code>min</code> nor <code>opt</code> is specified, the target skew is <code>0</code>. If the option <code>within_diff_pairs</code> is specified, the skew will be tested separately for every valid differential pair in the nets matching the rule. If <code>within_diff_pairs</code> is not specified, the skew will be tested across all matching nets (e.g. for skew tuning a bus).</p>
text_height	min/max	<p>Checks the height of text, including text boxes. An error will be generated for each text item that has a height below the <code>min</code> value (if specified) or above the <code>max</code> value (if specified).</p>

Constraint type	Argument type	Description
thermal_relief_gap	min	Specifies the width of the gap between a pad and a zone with a thermal-relief connection.
thermal_spoke_width	opt	Specifies the width of the spokes connecting a pad to a zone with a thermal-relief connection.
track_angle	min/max	Checks the angle between two connected track segments. An error will be generated for each connected pair with an angle below the min value (if specified) or above the max value (if specified).
track_segment_length	min/max	Checks the length of track and arc segments. An error will be generated for each segment that has a width below the min value (if specified) or above the max value (if specified).
track_width	min/opt/max	Checks the width of track and arc segments. An error will be generated for each segment that has a width below the min value (if specified) or above the max value (if specified).
via_count	min/max	Counts the number of vias on every net matched by the rule condition. An error will be generated for each net that has fewer vias than the min value (if specified) or more than the max value (if specified).
via_diameter	min/max	Checks the diameter of vias. An error will be generated for each via that has a diameter below the min value (if specified) or above the max value (if specified).
zone_connection	solid thermal_reliefs none	Specifies the connection to be made between a zone and a pad.

对象属性和函数参考

可以在自定义规则表达式中测试以下属性：

共有属性

这些属性适用于所有 PCB 对象。

Property	Data type	Description
Layer	string	The board layer on which the object exists. For objects that exist on more than one layer, this property will return the first layer (for example, F.Cu for most through-hole pads/vias).
Locked	boolean	True if the object is locked.
Parent	string	Returns the unique identifier of the parent object of this object.
Position_X	dimension	The position of the object's origin in the X-axis. Note that the origin of an object is not always the same as the center of the object's bounding box. For example, the origin of a footprint is the location of the (0, 0) coordinate of that footprint in the footprint editor, but the footprint may have been designed such that this location is not in the center of the courtyard shape.
Position_Y	dimension	The position of the object's origin in the Y-axis. Note that KiCad always uses Y-coordinates that increase from the top to bottom of the screen internally, even if you have configured your settings to show the Y-coordinates increasing from bottom to top.
Type	string	One of "Bitmap", "Dimension", "Footprint", "Graphic", "Group", "Leader", "Pad", "Target", "Text", "Text Box", "Track", "Via", or "Zone".

连接的对象属性

这些属性适用于可以分配网络的铜对象（焊盘、过孔、敷铜、布线）。

Property	Data type	Description
Net	integer	<p>The net code of the copper object.</p> <p>Note that net codes should not be relied upon to remain constant: if you need to refer to a specific net in a rule, use <code>NetName</code> instead. <code>Net</code> can be used to compare the nets of two objects with better performance, for example <code>A.Net == B.Net</code> is faster than <code>A.NetName == B.NetName</code>.</p>
NetClass	string	<p>The list of all net classes for the copper object. This is a priority ordered, comma delimited list where a net has multiple net classes assigned.</p> <p>Note that this list may include the <code>Default</code> net class, even if other net classes have been explicitly assigned to the net, because the <code>Default</code> net class provides fallback properties and design rules for any properties not defined by explicit net classes. See the net class documentation for more details.</p> <p>To check if a copper object is a member of a particular net class, regardless of any other net classes it may be a part of, use <code>hasNetclass(<netclass>)</code>.</p>

Property	Data type	Description
NetName	string	The name of the net for the copper object. Note that <code>Net</code> can be used instead in some situations for better performance; see the notes under <code>Net</code> .
Curved_Edges	boolean	True if curved edges are enabled for teardrops connected to the object.
Enable_Teardrops	boolean	True if teardrops are enabled for the object.
Prefer_Zone_Connections	boolean	True if the "Prefer zone connections" property is set for the object.
Allow_Teardrops_To_Span_Two_Tracks	boolean	True if the "Allow teardrops to span two tracks" property is set for the object.
Best_Length_Ratio	double	Best ratio of teardrop length to object size for teardrops connected to the object.
Best_Width_Ratio	double	Best ratio of teardrop width to object size for teardrops connected to the object.
Max_Length	dimension	Maximum length dimension for teardrops connected to the object.
Max_Width	dimension	Maximum width dimension for teardrops connected to the object.
Max_Width_Ratio	double	Maximum allowable ratio of object size to track width for teardrops connected to the object.

封装属性

这些属性适用于封装。

Property	Data type	Description
Clearance_Override	dimension	The copper clearance override set for the footprint.
Component_Class	string	The name of the component class set for the footprint. This is an alphabetically ordered, comma delimited list where a footprint has multiple component classes assigned. Note that while footprints have a <code>Component_Class</code> property, footprint child objects (such as pads) do not. To check if an object belongs to a footprint with a specific component class, use the <code>memberOfFootprint('\${Class:x}')</code> function.
Do_not_Populate	boolean	True if the footprint's "Do not populate" attribute is set.

Property	Data type	Description
Exclude_From_Position_Files	boolean	True if the footprint's "Exclude from position files" attribute is set.
Exclude_From_Bill_of_Materials	boolean	True if the footprint's "Exclude from bill of materials" attribute is set.
Exempt_From_Courtyard_Requirement	boolean	True if the footprint's "Exempt from courtyard requirement" attribute is set.
Keywords	string	The "Keywords" from the library footprint.
Library_Description	string	The link to the library footprint in library_name: footprint_name format.
Library_Link	string	The link to the library footprint in library_name: footprint_name format.
Not_in_Schematic	boolean	True if the footprint's "Not in schematic" attribute is set.
Orientation	double	The orientation (rotation) of the footprint in degrees.
Reference	string	The reference designator of the footprint. Note that while footprints have a Reference property, footprint child objects (such as pads) do not. To check if an object belongs to a footprint with a specific reference, use the <code>memberOfFootprint('x')</code> function.
Solderpaste_Margin_Override	dimension	The solder paste margin override set for the footprint.
Solderpaste_Margin_Ratio_Override	dimension	The solder paste margin ratio override set for the footprint.
Thermal_Relief_Gap	dimension	The thermal relief gap set for the footprint.
Thermal_Relief_Width	dimension	The thermal relief connection width set for the footprint.
Value	string	The contents of the "Value" field of the footprint.
Zone_Connection_Style	string	One of "Inherited", "None", "Thermal reliefs" or "Solid".

焊盘属性

这些属性适用于封装焊盘。

Property	Data type	Description
----------	-----------	-------------

Property	Data type	Description
Fabrication_Property	string	One of "None", "BGA pad", "Fiducial, global to board", "Fiducial, local to footprint", "Test point pad", "Heatsink pad", "Castellated pad".
Hole_Size_X	dimension	The size of the pad's drilled hole/slot in the X axis.
Hole_Size_Y	dimension	The size of the pad's drilled hole/slot in the Y axis.
Orientation	double	The orientation (rotation) of the pad in degrees.
Pad_Number	string	The "number" of a pad, which can be a string (for example "A1" in a BGA).
Pad_Shape	string	One of "Circle", "Rectangle", "Oval", "Trapezoid", "Rounded rectangle", "Chamfered rectangle", or "Custom".
Pad_To_Die_Length	dimension	The value of the "pad to die length" property of a pad, which is additional length added to the pad's net when calculating net length.
Pad_Type	string	One of "Through-hole", "SMD", "Edge connector", or "NPTH, mechanical".
Pin_Name	string	The name of the pad (usually the name of the corresponding pin in the schematic).
Pin_Type	string	<p>The electrical type of the pad (usually taken from the corresponding pin in the schematic). One of "Input", "Output", "Bidirectional", "Tri-state", "Passive", "Free", "Unspecified", "Power input", "Power output", "Open collector", "Open emitter", or "Unconnected".</p> <p>Pins with a no-connection flag on them will have a "+no_connect" suffix added to the pin type string. For example, "passive+no_connect" will match a passive pin with a no-connection flag. To match a pin type whether or not the pin has a no-connection flag, use a wildcard: "passive*" will match passive pins with or without a no-connection flag.</p>
Corner_Radius_Ratio	double	For rounded rectangle pads, the ratio of radius to rectangle size.
Size_X	dimension	The size of the pad in the X-axis.
Size_Y	dimension	The size of the pad in the Y-axis.
Soldermask_Margin_Override	dimension	The solder mask margin override set for the pad.
Solderpaste_Margin_Override	dimension	The solder paste margin override set for the pad.

Property	Data type	Description
Solderpaste_Margin_Ratio_Override	dimension	The solder paste margin ratio override set for the pad.
Thermal_Relief_Gap	dimension	The thermal relief gap set for the pad.
Thermal_Relief_Spoke_Angle	dimension	The thermal relief connection angle set for the pad.
Thermal_Relief_Spoke_Width	dimension	The thermal relief connection width set for the pad.
Zone_Connection_Style	string	One of "Inherited", "None", "Thermal reliefs" or "Solid".

布线和圆弧属性

这些属性适用于布线和弧形布线。

属性	数据类型	描述
Origin_X	dimension	起点的 X 坐标。
Origin_Y	dimension	起点的 Y 坐标。
End_X	dimension	终点的 X 坐标。
End_Y	dimension	终点的 Y 坐标。
Width	dimension	布线或圆弧的宽度。

过孔属性

这些属性适用于过孔。

Property	Data type	Description
Diameter	dimension	The diameter of the via's pad.
Hole	dimension	The diameter of the via's finished hole.
Layer_Bottom	string	The last layer in the via stackup.
Layer_Top	string	The first layer in the via stackup.
Via_Type	string	One of "Through", "Blind/buried", or "Micro".

Tuning Pattern Properties

These properties apply to tuning patterns.

Property	Data type	Description
End_X	dimension	The x-coordinate of the end point.
End_Y	dimension	The y-coordinate of the end point.
Min_Amplitude	dimension	The minimum amplitude of the tuning pattern.
Max_Amplitude	dimension	The maximum amplitude of the tuning pattern.
Tuning_Mode	string	One of "Single track", "Differential pair", or "Diff pair skew".
Initial_Side	string	One of "Left", "Right", or "Default".
Min_Spacing	dimension	The minimum spacing of the tuning pattern..
Corner_Radius_%	integer	The corner radius percentage of the tuning pattern.
Target_Length	dimension	The target length for the tuning pattern.
Target_Skew	dimension	The target skew for the tuning pattern.
Override_Custom_Rules	boolean	True if the tuning pattern overrides custom DRC rules.
Single-sided	boolean	True if the tuning pattern is single-sided.
Rounded	boolean	True if the tuning pattern uses rounded meanders.

敷铜和规则区域属性

这些属性适用于铜区和非铜区，以及规则区（以前称为禁止布线区）。

Property	Data type	Description
Clearance_Override	dimension	The copper clearance override set for the zone.
Min_Width	dimension	The minimum allowed width of filled areas in the zone.
Name	string	The user-specified name (blank by default).
Pad_Connections	string	One of "Inherited", "None", "Thermal reliefs", "Solid", or "Thermal Reliefs for PTH".
Priority	integer	The priority level of the zone.
Thermal_Relief_Gap	dimension	The thermal relief gap set for the zone.
Thermal_Relief_Width	dimension	The thermal relief connection width set for the zone.

图形形状属性

这些属性适用于图形线、圆弧、圆、矩形和多边形。

Property	Data type	Description
Angle	dimension	The angle of an arc.
End_X	dimension	The x-coordinate of the end point.
End_Y	dimension	The y-coordinate of the end point.
Filled	boolean	True if the shape is filled.
Line_Width	dimension	Thickness of the strokes of the shape.
Line_Style	string	One of "Solid", "Dashed", "Dotted", "Dash-Dot", "Dash-Dot-Dot".
Shape	string	One of "Segment", "Rectangle", "Arc", "Circle", "Polygon", or "Bezier".
Start_X	dimension	The x-coordinate of the start point.
Start_Y	dimension	The y-coordinate of the start point.

文本属性

这些属性适用于文本对象（封装字段、自由文本标签等）。

Property	Data type	Description
Bold	boolean	True if the text is bold.
Height	dimension	Height of a character in the font.
Horizontal_Justification	string	Horizontal text justification (alignment): one of "Left", "Center", or "Right".
Italic	boolean	True if the text is italic.
Knockout	boolean	True if the text has the knockout property set.
Mirrored	boolean	True if the text is mirrored.
Name	string	The name of a footprint field. For text objects that are not footprint fields, this is an empty string.
Text	string	The contents of the text object.
Thickness	dimension	Thickness of the stroke of the font.
Width	dimension	Width of a character in the font.
Vertical_Justification	string	Vertical text alignment: one of "Top", "Center", or "Bottom".
Visible	boolean	True if the text object is visible (displayed).

表达式函数

可以对自定义规则表达式中的对象调用以下函数：

Function	Objects	Description
<code>enclosedByArea('x')</code>	A or B	Returns true if all of the object is inside the named rule area or zone. Note that <code>enclosedByArea()</code> is slower than <code>intersectsArea()</code> . Use <code>intersectsArea()</code> where possible.
<code>existsOnLayer('layer_id')</code>	A or B	Returns true if the object exists on the given board layer. <code>layer_id</code> is a string containing the name of a board layer.
<code>fromTo('x', 'y')</code>	A or B	Returns true if the object exists on the copper path between the given pads. <code>x</code> and <code>y</code> are the full names of pads in the design, such as <code>'R1-Pad1'</code> .
<code>getField('x')</code>	A or B	Returns the value of field <code>x</code> in the object. Note that only footprints have fields, so no field will be returned unless the object is a footprint.
<code>hasComponentClass('x')</code>	A or B	Returns true if the set of component classes assigned to the object contains the named component class <code>x</code> . Note that only footprints have component classes, so this function will only return true if the object is a footprint. In most cases, you will want to check if an object is part of a footprint that has a specific component class. For this query, see the <code>memberOfFootprint()</code> expression function.
<code>hasNetclass('x')</code>	A or B	Returns true if the set of net classes assigned to the object contains the named net class <code>x</code> .
<code>inDiffPair('x')</code>	A or B	Returns true if the object is part of a differential pair and the base name of the pair matches the given argument <code>x</code> . For example, <code>inDiffPair('/USB_')</code> or <code>inDiffPair('/USB')</code> both return true for objects in the nets <code>/USB_P</code> and <code>/USB_N</code> . <code>*</code> and <code>?</code> can be used as wildcards, so <code>inDiffPair('/USB*')</code> matches <code>/USB1_P</code> and <code>/USB1_N</code> as well as <code>/USB2_P</code> and <code>/USB2_N</code> . Note this will always return false if the given net is not a diff pair, meaning that there isn't a matching net of the opposite polarity. So, on a board with a net named <code>/USB_P</code> but no net named <code>/USB_N</code> , this function returns false.
<code>insideArea('x')</code>	A or B	Returns true if any part of the object is inside the named rule area or zone. Rule area and zone names can be set in their respective properties dialogs. If the given area is a filled copper zone, the function tests if the given object is inside any of the filled copper regions of the zone, not if the object is inside the zone's outline. Deprecated; use <code>intersectsArea()</code> instead.

Function	Objects	Description
<code>insideCourtyard('x')</code> <code>insideFrontCourtyard('x')</code> <code>insideBackCourtyard('x')</code>	A or B	<p>Returns true if the any part of the object is inside the courtyard of the given footprint. The first variant checks both the front or back courtyard and returns true if the object is inside either one; the second and third variants check a courtyard on a specific layer. The named footprint <code>x</code> can be one of the following:</p> <ul style="list-style-type: none"> A reference designator, possibly containing wildcards <code>*</code> and <code>?</code>. <code>insideCourtyard('R?')</code> will check all footprints with references that contain <code>R</code> followed by a single character, while <code>insideCourtyard('R*')</code> will check all footprints with reference designators starting with <code>R</code>. A footprint library identifier in <code><footprint_library>:<footprint_name></code> format, possibly containing wildcards <code>*</code> and <code>?</code>. <code>insideCourtyard('Resistor_SMD:*')</code> will check all footprints in the <code>Resistor_SMD</code> library. A component class, in the form <code>#{Class:ClassName}</code>. The <code>Class</code> keyword is not case-sensitive, but component class names are case-sensitive. The function will return true if the object is inside the courtyard of a footprint with the named component class. <p>Deprecated; use <code>intersectsCourtyard()</code>, <code>intersectsFrontCourtyard()</code>, and <code>intersectsBackCourtyard()</code> instead.</p>
<code>intersectsArea('x')</code>	A or B	<p>Returns true if any part of the object is inside the named rule area or zone. Rule area and zone names can be set in their respective properties dialogs. If the given area is a filled copper zone, the function tests if the given object is inside any of the filled copper regions of the zone, not if the object is inside the zone's outline.</p>

Function	Objects	Description
intersectsCourtyard('x') intersectsFrontCourtyard('x') intersectsBackCourtyard('x')	A or B	Returns true if any part of the object is inside the courtyard of the given footprint. The first variant checks both the front or back courtyard and returns true if the object is inside either one; the second and third variants check a courtyard on a specific layer. The named footprint <code>x</code> can be one of the following: <ul style="list-style-type: none"> A reference designator, possibly containing wildcards <code>*</code> and <code>?</code>. <code>intersectsCourtyard('R?')</code> will check all footprints with references that contain <code>R</code> followed by a single character, while <code>intersectsCourtyard('R*')</code> will check all footprints with reference designators starting with <code>R</code>. A footprint library identifier in <code><footprint_library>: <footprint_name></code> format, possibly containing wildcards <code>*</code> and <code>?</code>. <code>intersectsCourtyard('Resistor_SMD:*')</code> will check all footprints in the <code>Resistor_SMD</code> library. A component class, in the form <code> \${Class:ClassName} </code>. The <code>Class</code> keyword is not case-sensitive, but component class names are case-sensitive. The function will return true if the object intersects the courtyard of a footprint with the named component class.
isBlindBuriedVia()	A or B	Returns true if the object is a blind/buried via.
isCoupledDiffPair()	AB	Returns true if the two objects being tested are part of the same differential pair but are opposite polarities. For example, returns true if <code>A</code> is in net <code>/USB+</code> and <code>B</code> is in net <code>/USB-</code> .
isMicroVia()	A or B	Returns true if the object is a microvia.
isPlated()	A or B	Returns true if the object is a plated hole (in a pad or via).
memberOf('x')	A or B	Returns true if the object is a member of the named group <code>x</code> . <p>Deprecated; use <code>memberOfGroup()</code> instead.</p>
memberOfGroup('x')	A or B	Returns true if the object is a member of a group named <code>x</code> .

Function	Objects	Description
memberOfFootprint('x')	A or B	<p>Returns true if the object is a member of the given footprint. The named footprint <code>x</code> can be one of the following:</p> <ul style="list-style-type: none"> • A reference designator, possibly containing wildcards <code>*</code> and <code>?</code>. <code>memberOfFootprint('R?')</code> will match all footprints with references that contain <code>R</code> followed by a single character, while <code>memberOfFootprint('R*')</code> will match all footprints with reference designators starting with <code>R</code>. • A footprint library identifier in <code><footprint_library>:<footprint_name></code> format, possibly containing wildcards <code>*</code> and <code>?</code>. <code>memberOfFootprint('Resistor_SMD:*')</code> will match all footprints in the <code>Resistor_SMD</code> library. A component class, in the form <code>#{Class:ClassName}</code>. The <code>Class</code> keyword is not case-sensitive, but component class names are case-sensitive. The function will return true if the object is a member of a footprint with the named component class.
memberOfSheet('x')	A or B	Returns true if the object is a member of a schematic sheet named <code>x</code> .

自定义设计规则示例

Basic examples

```
(rule RF_width
  (layer outer)
  (condition "A.hasNetclass('RF')")
  (constraint track_width (min 0.35mm) (max 0.35mm)))

(rule "BGA neckdown"
  (constraint track_width (min 0.2mm) (opt 0.25mm))
  (constraint clearance (min 0.05mm) (opt 0.08mm))
  (condition "A.intersectsCourtyard('U3')"))

# Specify an optimal gap for a particular differential pair
(rule "Clock gap"
  (condition "A.inDiffPair('/CLK')")
  (constraint diff_pair_gap (opt 0.8mm)))

# Specify a larger clearance between differential pairs and anything else
(rule "Differential pair clearance"
  (condition "A.inDiffPair('*') && !AB.isCoupledDiffPair()")
  (constraint clearance (min 1.5mm)))

(rule "copper keepout"
  (constraint disallow track via zone)
  (condition "A.intersectsArea('zone3')"))
```

Various clearances

```
(rule "Clearance between Pads of Different Nets"
  (constraint clearance (min 3.0mm))
  (condition "A.Type == 'Pad' && B.Type == 'Pad' && A.Net != B.Net"))

(rule "Pad to Track Clearance"
  (constraint clearance (min 0.2mm))
  (condition "A.Type == 'Pad' && B.Type == 'Track'"))

# Enforce a clearance around pads (and other copper objects) in a specific footprint
(rule "Pad clearance in R1"
  (constraint clearance (min 1mm))
  (condition "A.memberOfFootprint('TP1')"))

# Enforce a mechanical clearance between components and board edge
(rule front_mechanical_board_edge_clearance
  (layer "F.Courtyard")
  (constraint physical_clearance (min 3mm))
  (condition "B.Layer == 'Edge.Cuts'"))

# Prevent copper pours under capacitors
(rule "No copper pours under capacitors"
  (constraint physical_clearance (min 0.1mm))
  (condition "A.Type == 'Zone' && B.Reference == 'C*'))
)

# This assumes that there is a cutout with 1mm thick lines
(rule "Clearance to cutout"
  (constraint edge_clearance (min 0.8mm))
  (condition "A.Layer=='Edge.Cuts' && A.Line_Width == 1.0mm"))

# prevent silk over tented vias
(rule silk_over_via
  (constraint silk_clearance (min 0.2mm))
  (condition "A.Type == '*Text' && B.Type == 'Via'"))

(rule "Allow connector silk to intersect board edge"
  (constraint silk_clearance)
  (severity ignore)
  (condition "A.memberOfFootprint('J*') && B.Layer=='Edge.Cuts'"))

(rule "Distance between Vias of Different Nets"
  (constraint hole_to_hole (min 0.254mm))
  (condition "A.Type == 'Via' && B.Type == 'Via' && A.Net != B.Net"))

(rule "Via Hole to Track Clearance"
  (constraint hole_clearance (min 0.254mm))
  (condition "A.Type == 'Via' && B.Type == 'Track'"))

(rule "Distance between test points"
  (constraint courtyard_clearance (min 1.5mm))
  (condition "A.Reference == 'TP*' && B.Reference == 'TP*'))
```